

- Advanced Process Technology
- Surface Mount
- Optimized for 4.5V-7.0V Gate Drive
- Ideal for CPU Core DC-DC Converters
- Fast Switching
- Lead-Free

Description

These HEXFET Power MOSFETs were designed specifically to meet the demands of CPU core DC-DC converters. Advanced processing techniques combined with an optimized gate oxide design results in a die sized specifically to offer maximum efficiency at minimum cost.

The D²Pak is a surface mount power package capable of accommodating die sizes up to HEX-4. It provides the highest power capability and the lowest possible on-resistance in any existing surface mount package. The D²Pak is suitable for high current applications because of its low internal connection resistance and can dissipate up to 2.0W in a typical surface mount application.

Absolute Maximum Ratings

	Parameter	Max.	Units
$I_D @ T_C = 25^\circ\text{C}$	Continuous Drain Current, $V_{GS} @ 4.5\text{V}^{\text{⑤}}$	61	A
$I_D @ T_C = 100^\circ\text{C}$	Continuous Drain Current, $V_{GS} @ 4.5\text{V}^{\text{⑤}}$	39	
I_{DM}	Pulsed Drain Current ①⑤	240	
$P_D @ T_C = 25^\circ\text{C}$	Power Dissipation	89	W
	Linear Derating Factor	0.71	W/°C
V_{GS}	Gate-to-Source Voltage	± 10	V
E_{AS}	Single Pulse Avalanche Energy②⑤	220	mJ
I_{AR}	Avalanche Current①	35	A
E_{AR}	Repetitive Avalanche Energy①	8.9	mJ
dv/dt	Peak Diode Recovery dv/dt ③⑤	5.0	V/ns
T_J	Operating Junction and	-55 to + 150	°C
T_{STG}	Storage Temperature Range		
	Soldering Temperature, for 10 seconds		

Thermal Resistance

	Parameter	Typ.	Max.	Units
R_{qJC}	Junction-to-Case	---	1.4	°C/W
R_{qJA}	Junction-to-Ambient (PCB Mounted, steady-state)**	---	40	

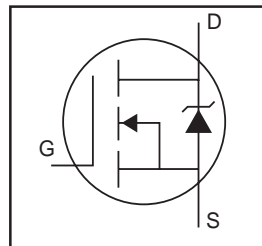

$V_{DSS} = 20\text{V}$
$R_{DS(on)} = 0.013\Omega$
$I_D = 61\text{A}$

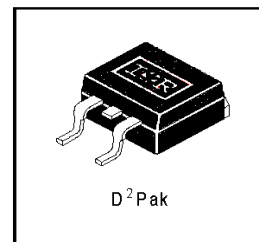

IRL3102SPbF

International
IRF Rectifier

Electrical Characteristics @ T_J = 25°C (unless otherwise specified)

	Parameter	Min.	Typ.	Max.	Units	Conditions
V _{(BR)DSS}	Drain-to-Source Breakdown Voltage	20	—	—	V	V _{GS} = 0V, I _D = 250μA
DV _{(BR)DSS} /DT _J	Breakdown Voltage Temp. Coefficient	—	0.016	—	V/°C	Reference to 25°C, I _D = 1mA ^⑤
R _{DS(on)}	Static Drain-to-Source On-Resistance	—	—	0.015	Ω	V _{GS} = 4.5V, I _D = 37A ^④
		—	—	0.013		V _{GS} = 7.0V, I _D = 37A ^④
V _{GS(th)}	Gate Threshold Voltage	0.70	—	—	V	V _{DS} = V _{GS} , I _D = 250μA
g _{fs}	Forward Transconductance	36	—	—	S	V _{DS} = 16V, I _D = 35A ^⑤
I _{DSS}	Drain-to-Source Leakage Current	—	—	25	μA	V _{DS} = 20V, V _{GS} = 0V
		—	—	250		V _{DS} = 10V, V _{GS} = 0V, T _J = 150°C
I _{GSS}	Gate-to-Source Forward Leakage	—	—	100	nA	V _{GS} = 10V
	Gate-to-Source Reverse Leakage	—	—	-100		V _{GS} = -10V
Q _g	Total Gate Charge	—	—	58	nC	I _D = 35A
Q _{gs}	Gate-to-Source Charge	—	—	14		V _{DS} = 16V
Q _{gd}	Gate-to-Drain ("Miller") Charge	—	—	21		V _{GS} = 4.5V, See Fig. 6 ^{④⑤}
t _{d(on)}	Turn-On Delay Time	—	10	—	ns	V _{DD} = 10V
t _r	Rise Time	—	130	—		I _D = 35A
t _{d(off)}	Turn-Off Delay Time	—	80	—		R _G = 9.0Ω, V _{GS} = 4.5V
t _f	Fall Time	—	110	—		R _D = 0.28Ω, ^{④⑤}
L _S	Internal Source Inductance	—	7.5	—	nH	Between lead, and center of die contact
C _{iss}	Input Capacitance	—	2500	—	pF	V _{GS} = 0V
C _{oss}	Output Capacitance	—	1000	—		V _{DS} = 15V
C _{rss}	Reverse Transfer Capacitance	—	360	—		f = 1.0MHz, See Fig. 5

Source-Drain Ratings and Characteristics

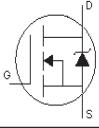
	Parameter	Min.	Typ.	Max.	Units	Conditions
I _S	Continuous Source Current (Body Diode)	—	—	61	A	MOSFET symbol showing the integral reverse p-n junction diode. 
I _{SM}	Pulsed Source Current (Body Diode) ^{①⑤}	—	—	240		
V _{SD}	Diode Forward Voltage	—	—	1.3	V	T _J = 25°C, I _S = 37A, V _{GS} = 0V ^④
t _{rr}	Reverse Recovery Time	—	59	88	ns	T _J = 25°C, I _F = 35A
Q _{rr}	Reverse Recovery Charge	—	110	160	nC	di/dt = 100A/μs ^{④⑤}
t _{on}	Forward Turn-On Time	Intrinsic turn-on time is negligible (turn-on is dominated by L _S +L _D)				

Notes:

- ① Repetitive rating; pulse width limited by max. junction temperature.
- ② Starting T_J = 25°C, L = 0.36mH
R_G = 25Ω, I_{AS} = 35A.
- ③ I_{SD} ≤ 35A, di/dt ≤ 100A/μs, V_{DD} ≤ V_{(BR)DSS}, T_J ≤ 150°C
- ④ Pulse width ≤ 300μs; duty cycle ≤ 2%.
- ⑤ Uses IRL3102 data and test conditions

** When mounted on FR-4 board using minimum recommended footprint.
For recommended footprint and soldering techniques refer to application note #AN-994.

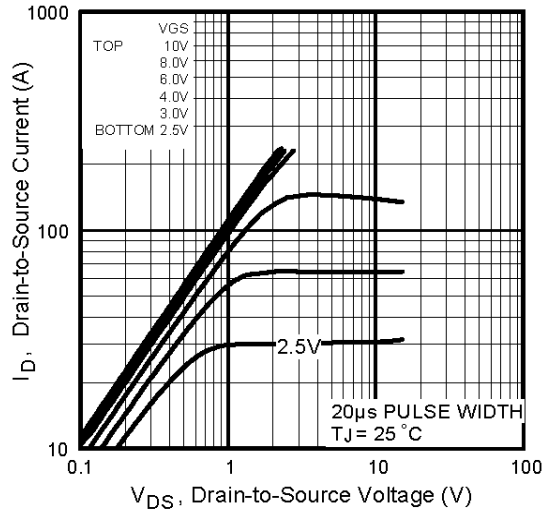

Fig 1. Typical Output Characteristics

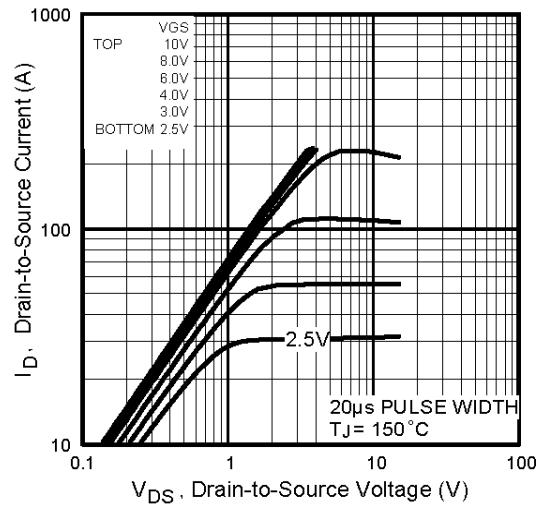

Fig 2. Typical Output Characteristics

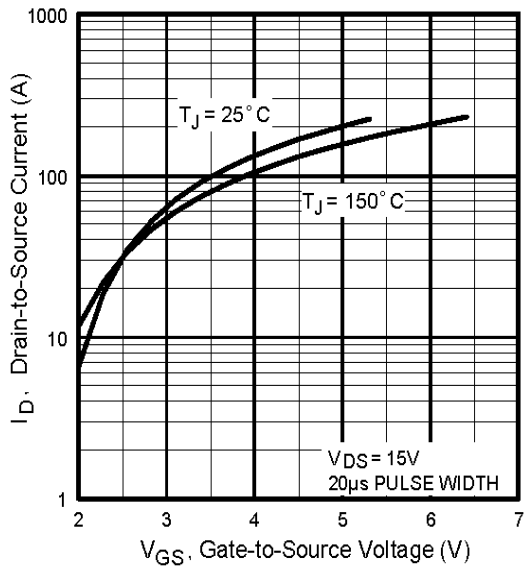

Fig 3. Typical Transfer Characteristics

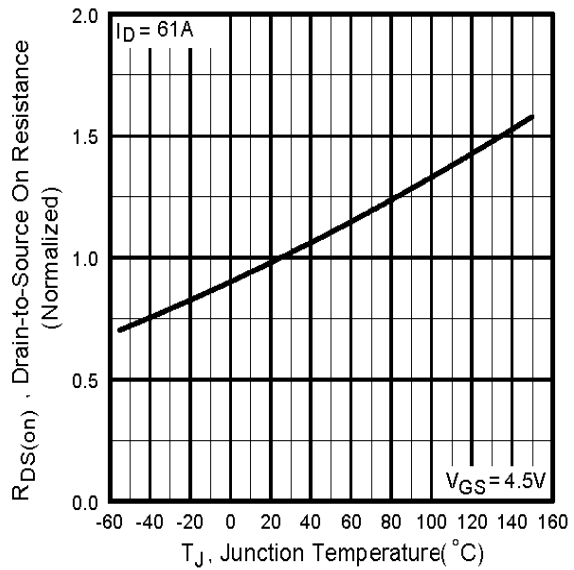

Fig 4. Normalized On-Resistance Vs. Temperature

IRL3102SPbF

International
IR Rectifier

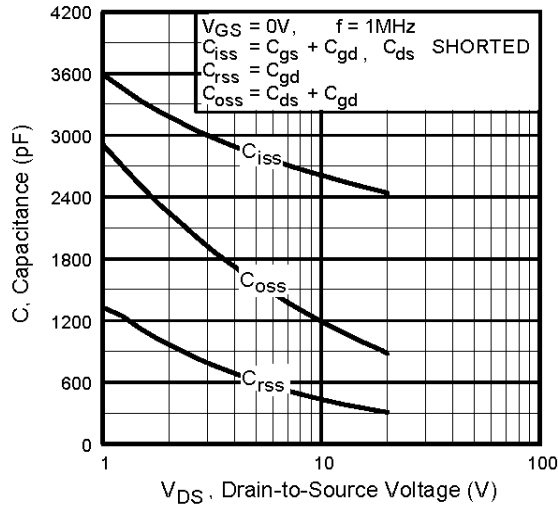

Fig 5. Typical Capacitance Vs. Drain-to-Source Voltage

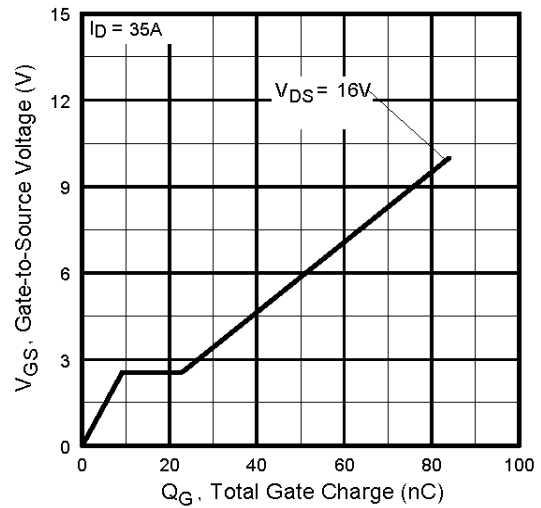

Fig 6. Typical Gate Charge Vs. Gate-to-Source Voltage

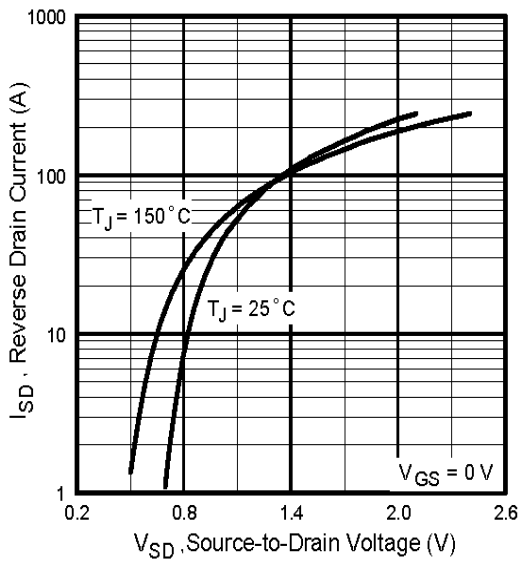

Fig 7. Typical Source-Drain Diode Forward Voltage

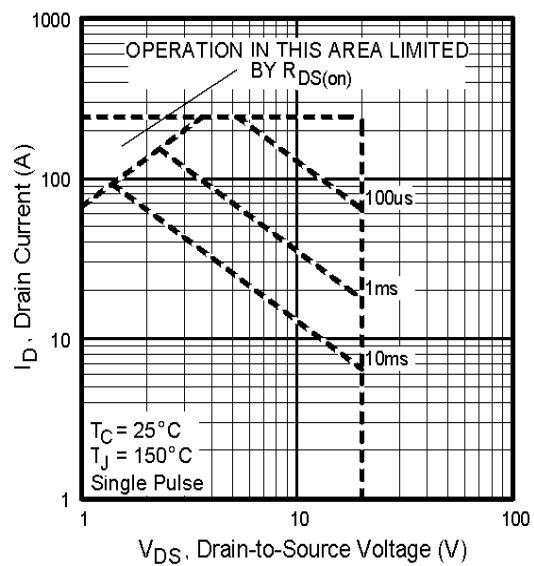

Fig 8. Maximum Safe Operating Area

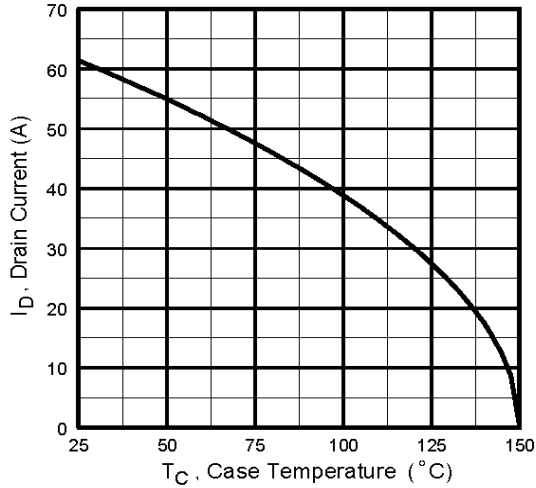

Fig 9. Maximum Drain Current Vs. Case Temperature

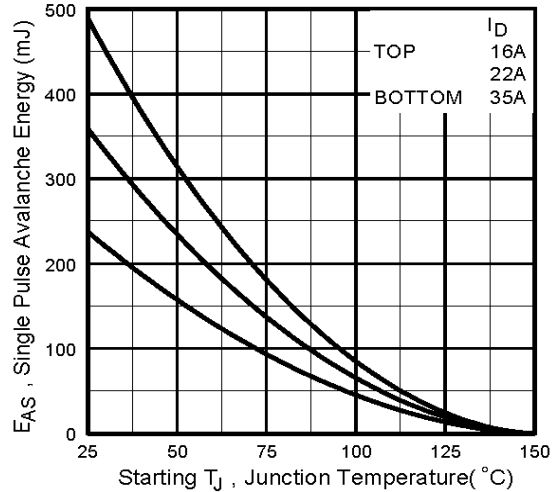

Fig 10. Maximum Avalanche Energy Vs. Drain Current

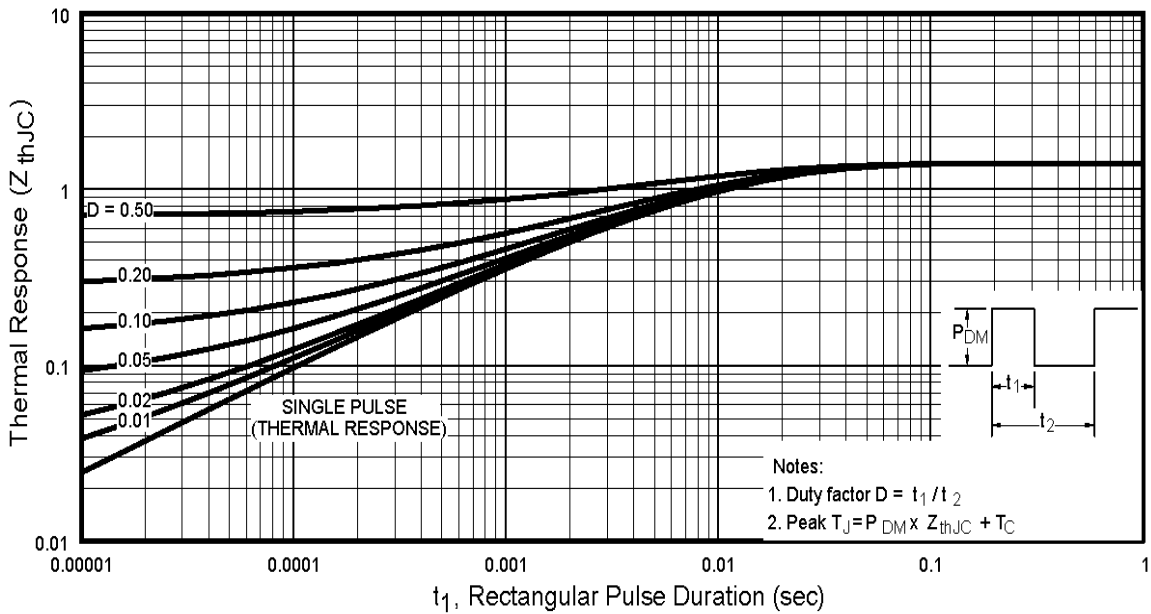

Fig 11. Maximum Effective Transient Thermal Impedance, Junction-to-Case

IRL3102SPbF

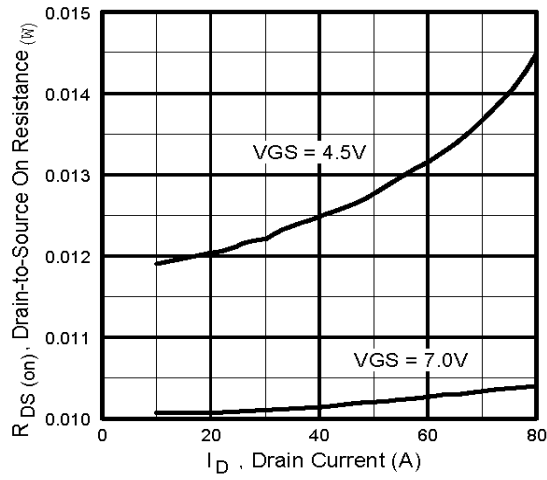

Fig 12. On-Resistance Vs. Drain Current

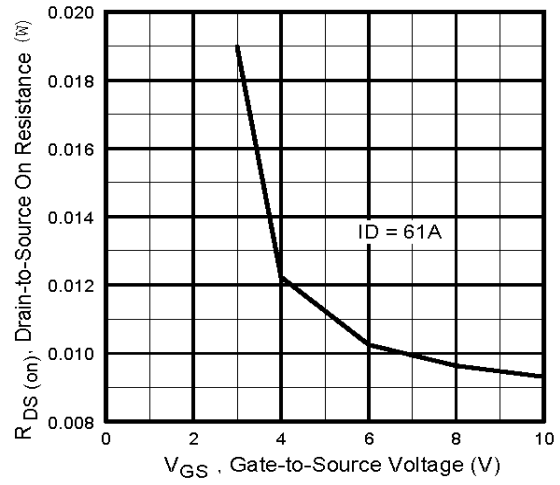
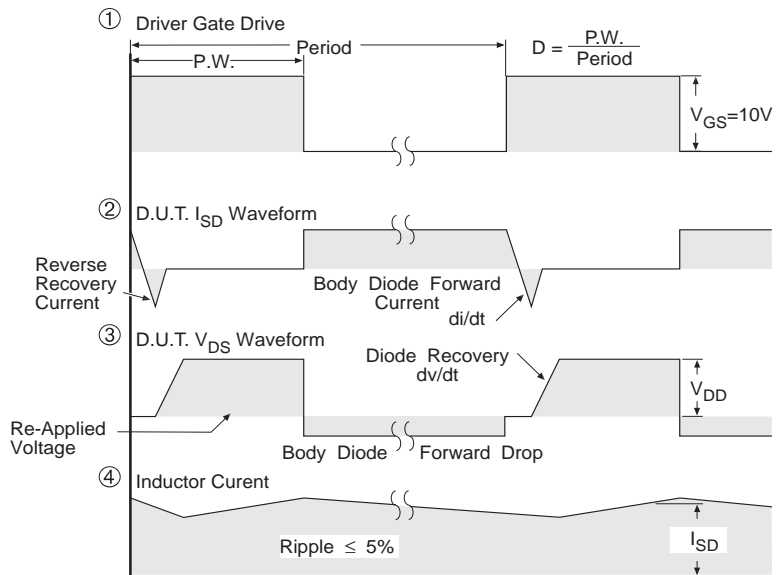

Fig 13. On-Resistance Vs. Gate Voltage

Peak Diode Recovery dv/dt Test Circuit



* Reverse Polarity for P-Channel
** Use P-Channel Driver for P-Channel Measurements



*** $V_{GS} = 5.0V$ for Logic Level and 3V Drive Devices

Fig 14 For N Channel HEXFETS

IRL3102SPbF

D²Pak Package Outline

Dimensions are shown in millimeters (inches)

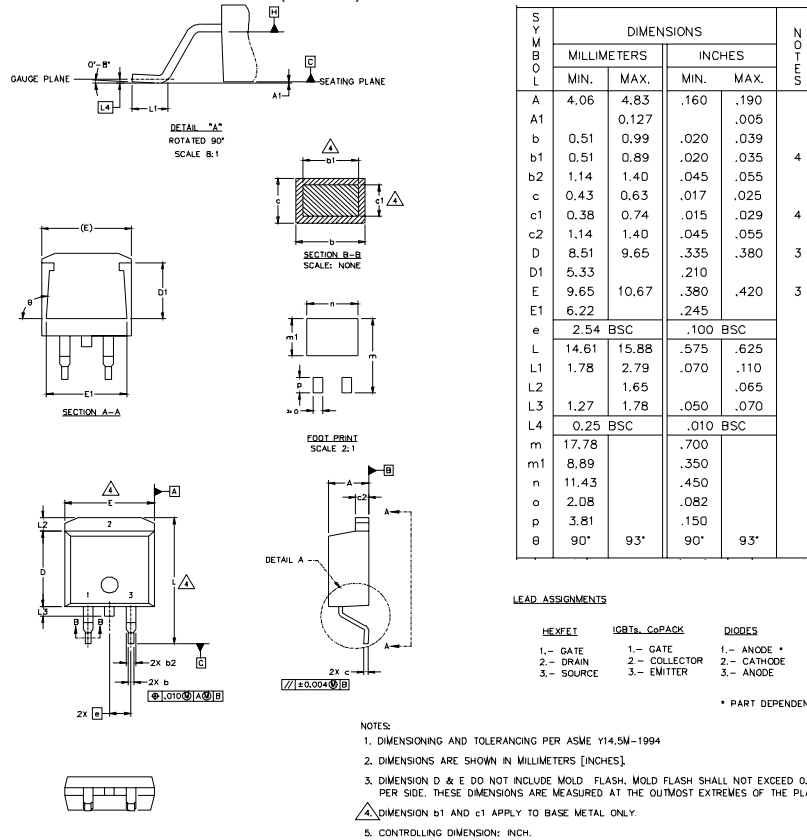

D²Pak Part Marking Information

EXAMPLE: THIS IS AN IRF530S WITH LOT CODE 8024 ASSEMBLED ON WW 02, 2000 IN THE ASSEMBLY LINE "L"

Note: "P" in assembly line position indicates "Lead-Free"

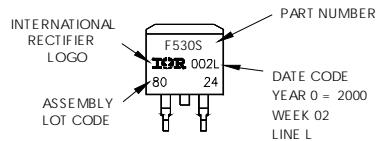

OR

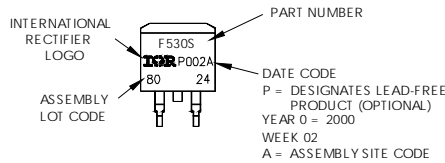

D²Pak Tape & Reel Information

Dimensions are shown in millimeters (inches)

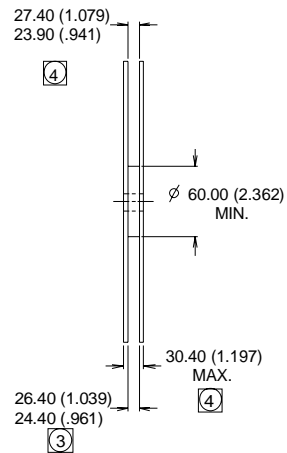
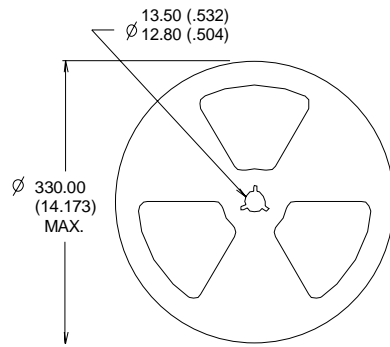
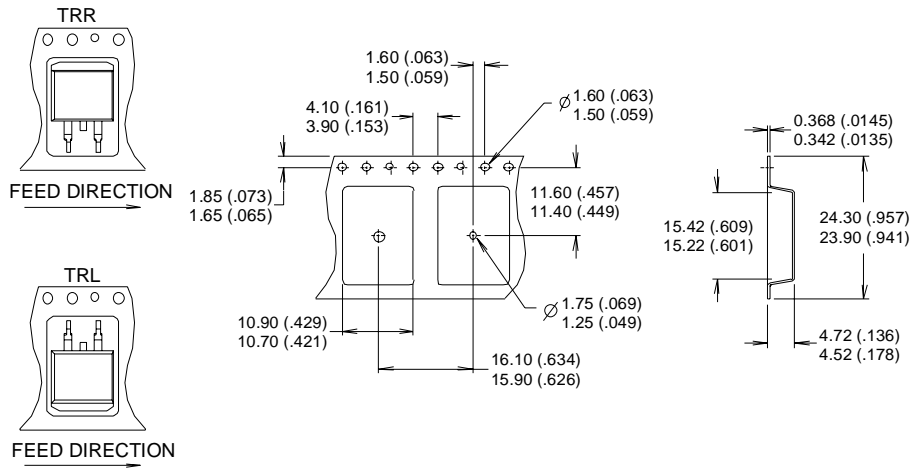

- NOTES:
1. CONFORMS TO EIA-418.
 2. CONTROLLING DIMENSION: MILLIMETER.
 - ③ DIMENSION MEASURED @ HUB.
 - ④ INCLUDES FLANGE DISTORTION @ OUTER EDGE.

Data and specifications subject to change without notice.