

## FEATURES

- ❑ Extremely Lower  $R_{DS(ON)}$
- ❑ Improved Inductive Ruggedness
- ❑ Fast Switching Times
- ❑ Rugged Polysilicon Gate Cell Structure
- ❑ Low Input Capacitance
- ❑ Extended Safe Operating Area
- ❑ Improved High Temperature Reliability
- ❑ Surface Mounting Package : **8SOP**

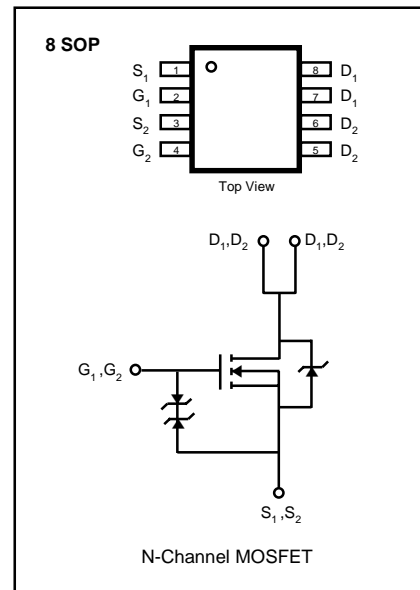

## Absolute Maximum Ratings

Symbol	Characteristic	Value	Units
$V_{DSS}$	Drain-to-Source Voltage(1)	50	V
$V_{DGR}$	Drain-Gate Voltage( $R_{GS}=1.0M\Omega$ )(1)	50	V
$V_{GS}$	Gate-to-Source Voltage	$\pm 20$	V
$I_D$	Continuous Drain Current $T_A=25^\circ C$	2.0	A
$I_D$	Continuous Drain Current $T_A=100^\circ C$	1.6	A
$I_{DM}$	Drain Current-Pulsed (2)	8.0	V
$P_D$	Total Power Dissipation $T_A=25^\circ C$ $T_A=70^\circ C$	2.0	W
		1.3	
$T_J, T_{STG}$	Operating and Storage Junction Temperature Range	- 55 to +150	$^\circ C$
$T_L$	Maximum Lead Temp. for Soldering Purposes, 1/16" from case for 5 seconds	300	

## Notes ;

(1)  $T_J=25^\circ C$  to  $150^\circ C$ 

(2) Repetitive Rating : Pulse Width Limited by Max. Junction Temperature

### Electrical Characteristics ( $T_A=25^\circ\text{C}$ unless otherwise specified)

Symbol	Characteristic	Min.	Typ.	Max.	Units	Test Condition
$BV_{DSS}$	Drain-Source Breakdown Voltage	600	--	--	V	$V_{GS}=0V, I_D=250\mu A$
$V_{GS(th)}$	Gate Threshold Voltage	2.0	--	4.0	V	$V_{DS}=V_{GS}, I_D=250\mu A$
$I_{GSS}$	Gate-Source Leakage, Forward	--	--	1.0	$\mu A$	$V_{GS}=20V$
	Gate-Source Leakage, Reverse	--	--	-1.0	$\mu A$	$V_{GS}=-20V$
$I_{DSS}$	Drain-to-Source Leakage Current	--	--	2	$\mu A$	$V_{DS}=50V$
		--	--	25		$V_{DS}=40V, T_J=55^\circ\text{C}$
$I_{DON}$	On-State Drain-Source Current(2)	8.0	--	--	A	$V_{GS}=10V, V_{DS}=5V$
$R_{DS(on)}$	Static Drain-Source			0.3	$\Omega$	$V_{GS}=10V, I_D=1.5A$
	On-State Resistance(2)			0.5		$V_{GS}=5.0V, I_D=0.6A$
$g_{fs}$	Forward Transconductance	--	2.5	--	S	$V_{DS} \geq 15V, I_D=2.0A$
$t_{d(on)}$	Turn-On Delay Time	--	--	40	ns	$V_{DD}=30V, I_D=0.6A,$ $Z_\theta=6.0\Omega,$
$t_r$	Rise Time	--	--	70		
$t_{d(off)}$	Turn-Off Delay Time	--	--	100		
$t_f$	Fall Time	--	--	70		
$Q_g$	Total Gate Charge	--	--	15	nC	$V_{DS}=25V, V_{GS}=10V,$ $I_D=1.3A$
$Q_{gs}$	Gate-Source Charge	--	1.0	--		
$Q_{gd}$	Gate-Drain ("Miller") Charge	--	2.0	--		

### Thermal Resistance

Symbol	Characteristic	Typ.	Max.	Units
$R_{\theta JA}$	Junction-to-Ambient	--	62.5	$^\circ\text{C/W}$

#### Notes ;

- $T_J=25^\circ\text{C}$  to  $150^\circ\text{C}$
- Pulse Test : Pulse Width  $\leq 300\mu\text{s}$ , Duty Cycle  $\leq 2\%$

### Source-Drain Diode Ratings and Characteristics

Symbol	Characteristic	Min.	Typ.	Max.	Units	Test Condition
$I_S$	Continuous Source Current (Body Diode)	--	--	1.8	A	Modified MOSFET Symbol Showing the Integral Reverse P-N Junction Rectifier 
$V_{SD}$	Diode Forward Voltage(2)	--	--	1.2	V	$T_J=25^\circ\text{C}, I_S=1.25A, V_{GS}=0V$
$t_{rr}$	Reverse Recovery Time	--	--	100	ns	$T_J=25^\circ\text{C}, I_F=2.5A, di_F/dt=100A/\mu\text{s}$

Fig 1. Output Characteristics

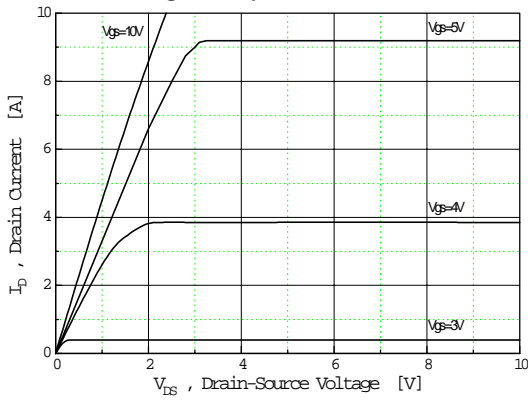

Fig 2. Transfer Characteristics

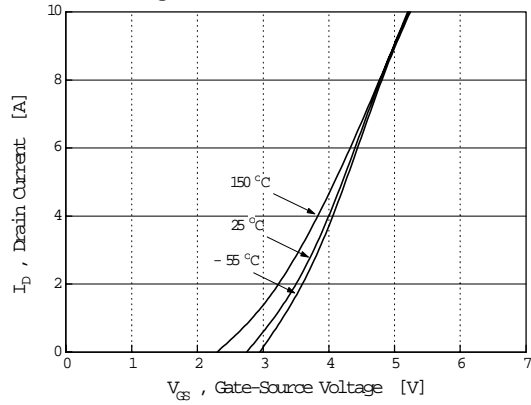

Fig 3. On-Resistance vs. Drain Current

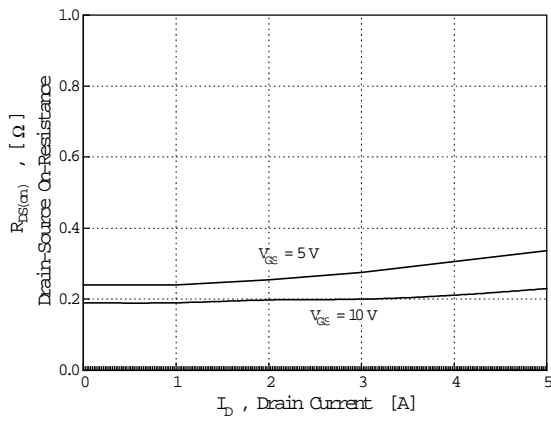

Fig 4. Capacitance vs. Drain-Source Voltage

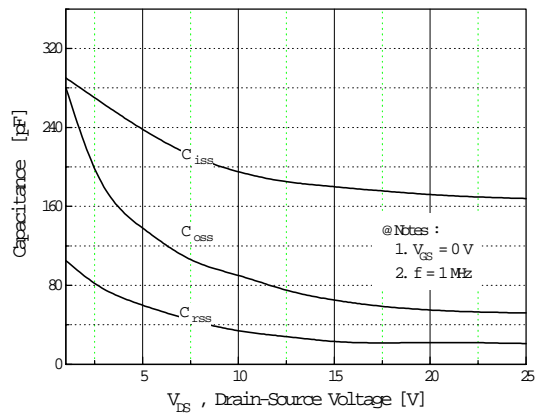

Fig 5. Breakdown Voltage vs. Temperature

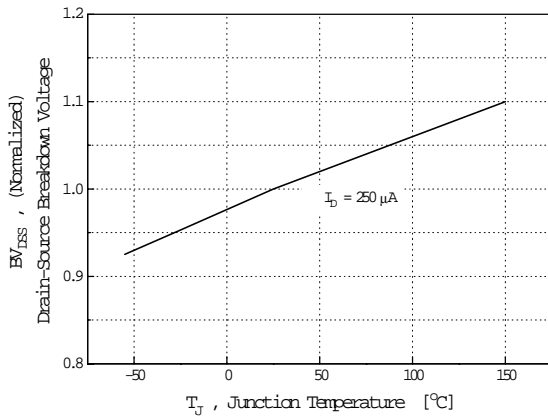
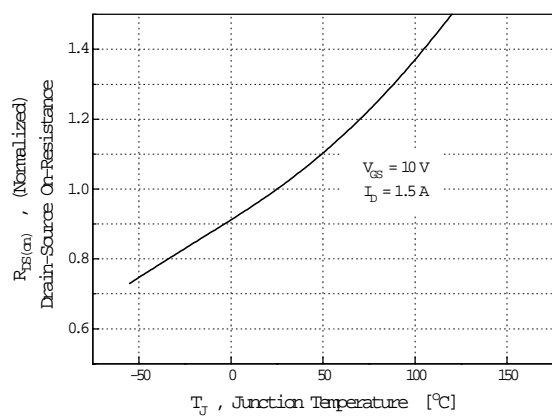
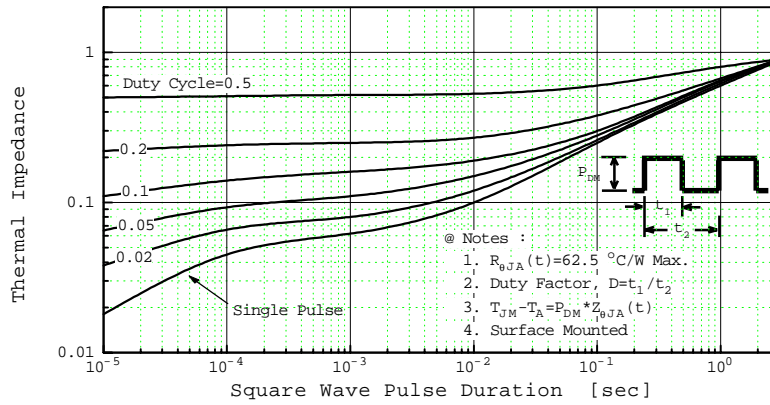

Fig 6. Normalized On-Resistance vs. Temperature



**Fig 7. Normalized Effective Transient Thermal Impedance, Junction-to-Ambient**



**Fig 8. Source-Drain Diode Forward Voltage**

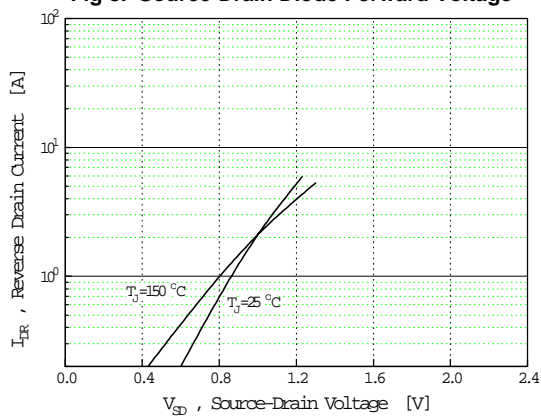

**Fig 9. Gate Charge vs. Gate-Source Voltage**

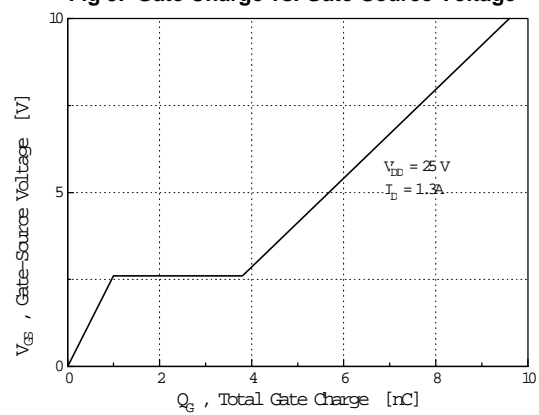

**Fig 10. Threshold Voltage**

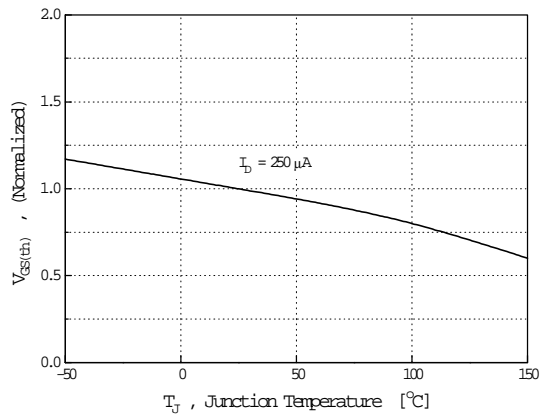

## TRADEMARKS

The following are registered and unregistered trademarks Fairchild Semiconductor owns or is authorized to use and is not intended to be an exhaustive list of all such trademarks.

ACE <sub>x</sub> <sup>™</sup>	FAST <sup>®</sup>	MICROWIRE <sup>™</sup>	SILENT SWITCHER <sup>®</sup>	UHC <sup>™</sup>
Bottomless <sup>™</sup>	FAST <sub>r</sub> <sup>™</sup>	OPTOLOGIC <sup>®</sup>	SMART START <sup>™</sup>	UltraFET <sup>®</sup>
CoolFET <sup>™</sup>	FRFET <sup>™</sup>	OPTOPLANAR <sup>™</sup>	SPM <sup>™</sup>	VCX <sup>™</sup>
CROSSVOLT <sup>™</sup>	GlobalOptoisolator <sup>™</sup>	PACMAN <sup>™</sup>	STAR*POWER <sup>™</sup>	
DenseTrench <sup>™</sup>	GTO <sup>™</sup>	POP <sup>™</sup>	Stealth <sup>™</sup>	
DOME <sup>™</sup>	HiSeC <sup>™</sup>	Power247 <sup>™</sup>	SuperSOT <sup>™</sup> -3	
EcoSPARK <sup>™</sup>	I <sup>2</sup> C <sup>™</sup>	PowerTrench <sup>®</sup>	SuperSOT <sup>™</sup> -6	
E <sup>2</sup> CMOS <sup>™</sup>	ISOPLANAR <sup>™</sup>	QFET <sup>™</sup>	SuperSOT <sup>™</sup> -8	
EnSigna <sup>™</sup>	LittleFET <sup>™</sup>	QS <sup>™</sup>	SyncFET <sup>™</sup>	
FACT <sup>™</sup>	MicroFET <sup>™</sup>	QT Optoelectronics <sup>™</sup>	TinyLogic <sup>™</sup>	
FACT Quiet Series <sup>™</sup>	MicroPak <sup>™</sup>	Quiet Series <sup>™</sup>	TruTranslation <sup>™</sup>	

STAR\*POWER is used under license

## DISCLAIMER

FAIRCHILD SEMICONDUCTOR RESERVES THE RIGHT TO MAKE CHANGES WITHOUT FURTHER NOTICE TO ANY PRODUCTS HEREIN TO IMPROVE RELIABILITY, FUNCTION OR DESIGN. FAIRCHILD DOES NOT ASSUME ANY LIABILITY ARISING OUT OF THE APPLICATION OR USE OF ANY PRODUCT OR CIRCUIT DESCRIBED HEREIN; NEITHER DOES IT CONVEY ANY LICENSE UNDER ITS PATENT RIGHTS, NOR THE RIGHTS OF OTHERS.

## LIFE SUPPORT POLICY

FAIRCHILD'S PRODUCTS ARE NOT AUTHORIZED FOR USE AS CRITICAL COMPONENTS IN LIFE SUPPORT DEVICES OR SYSTEMS WITHOUT THE EXPRESS WRITTEN APPROVAL OF FAIRCHILD SEMICONDUCTOR CORPORATION.

As used herein:

1. Life support devices or systems are devices or systems which, (a) are intended for surgical implant into the body, or (b) support or sustain life, or (c) whose failure to perform when properly used in accordance with instructions for use provided in the labeling, can be reasonably expected to result in significant injury to the user.
2. A critical component is any component of a life support device or system whose failure to perform can be reasonably expected to cause the failure of the life support device or system, or to affect its safety or effectiveness.

## PRODUCT STATUS DEFINITIONS

### Definition of Terms

Datasheet Identification	Product Status	Definition
Advance Information	Formative or In Design	This datasheet contains the design specifications for product development. Specifications may change in any manner without notice.
Preliminary	First Production	This datasheet contains preliminary data, and supplementary data will be published at a later date. Fairchild Semiconductor reserves the right to make changes at any time without notice in order to improve design.
No Identification Needed	Full Production	This datasheet contains final specifications. Fairchild Semiconductor reserves the right to make changes at any time without notice in order to improve design.
Obsolete	Not In Production	This datasheet contains specifications on a product that has been discontinued by Fairchild semiconductor. The datasheet is printed for reference information only.