

ADJUSTABLE LOW DROPOUT VOLTAGE REGULATOR

■ GENERAL DESCRIPTION

The NJM2887 is an adjustable low dropout voltage regulator with ON/OFF control.

Advanced Bipolar technology achieves low noise, high ripple rejection and low quiescent current.

It is suitable for DVD, FAX and Car Audio.

■ PACKAGE OUTLINE

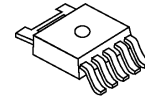

NJM2887DL3

■ FEATURES

- High Ripple Rejection 70dB typ. (f=1kHz, Vo=3V Version)
- Output Noise Voltage Vno=50μVrms typ.
- Output capacitor with 2.2μF ceramic capacitor
- Output Current Io(max.)=500mA
- High Precision Output Vref=1.29V±1.0%
- Low Dropout Voltage 0.18V typ. (Io=300mA)
- ON/OFF Control
- Internal Short Circuit Current Limit
- Internal Thermal Overload Protection
- Bipolar Technology
- Package Outline TO-252-5(DL3)

■ PIN CONFIGURATION

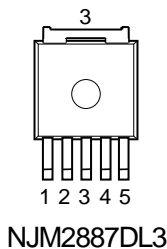

- PIN FUNCTION**
1. CONTROL
 2. V_{IN}
 3. GND
 4. V_{OUT}
 5. V_{ADJ}

■ BLOCK DIAGRAM

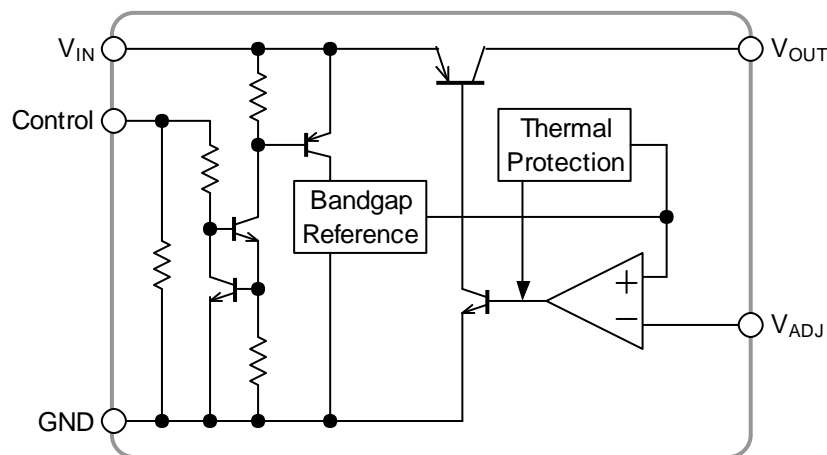

NJM2887

■ ABSOLUTE MAXIMUM RATINGS

(Ta=25°C)

PARAMETER	SYMBOL	RATINGS	UNIT
Input Voltage	V _{IN}	+14	V
Control Voltage	V _{CONT}	+14(*1)	V
Output Adjust Voltage	V _{ADJ}	+4	V
Power Dissipation	P _D	950(*2) 2500(*3)	mW
Operating Temperature	Topr	-40 ~ +85	°C
Storage Temperature	Tstg	-40 ~ +125	°C

(*1): When input voltage is less than +14V, the absolute maximum control voltage is equal to the input voltage.

(*2): Mounted on glass epoxy board. (76.2×114.3×1.6mm: based on EIA/JEDEC standard size, 2Layers, Cu area 100mm²)

(*3): Mounted on glass epoxy board. (76.2×114.3×1.6mm: based on EIA/JEDEC standard, 4Layers)

(For 4Layers: Applying 74.2×74.2mm inner Cu area and a thermal via hole to a board based on JEDEC standard JESD51-5)

■ Operating Voltage Range

$$V_{IN}=+2.3V \sim +14.0V$$

■ ELECTRICAL CHARACTERISTICS

(Unless otherwise noted, V_{IN}=V_o+1V, R₁=100kΩ, C_{IN}=0.33μF, C_o=2.2μF:V_o (C_o=4.7μF: V_o≤2.6V), Ta=25°C)

PARAMETER	SYMBOL	TEST CONDITION	MIN.	TYP.	MAX.	UNIT
Output Voltage	V _o	I _o =30mA	1.5	-	6	V
Reference Voltage	V _{ref}	I _o =30mA	1.277	1.29	1.303	V
Quiescent Current	I _q	I _o =0mA, V _o =3.0V	-	200	300	μA
Quiescent Current at Control OFF	I _{q(OFF)}	V _{CONT} =0V	-	-	100	nA
Output Current	I _o	V _o -0.3V	500	650	-	mA
Line Regulation	ΔV _o /ΔV _{IN}	V _{IN} =V _o +1V ~ V _o +6.0V, I _o =30mA	-	-	0.10	%/V
Load Regulation	ΔV _o /ΔI _o	I _o =0 ~ 500mA	-	-	0.03	%/mA
Dropout Voltage(*4)	ΔV _{I-O}	I _o =300mA	-	0.18	0.28	V
Ripple Rejection	RR	e _{in} =200mVrms, f=1kHz, I _o =10mA V _o =3.0V Version	-	70	-	dB
Average Temperature Coefficient of Output Voltage	ΔV _o /ΔTa	Ta=0~85°C, I _o =10mA	-	±50	-	ppm/°C
Output Noise Voltage	V _{NO}	f=10Hz~80kHz, I _o =10mA, V _o =3.0V Version	-	50	-	μVrms
Control Voltage for ON-state	V _{CONT(ON)}		1.6	-	-	V
Control Voltage for OFF-state	V _{CONT(OFF)}		-	-	0.6	V

(*4): Except output voltage less than 2.1V.

POWER DISSIPATION VS. AMBIENT TEMPERATURE

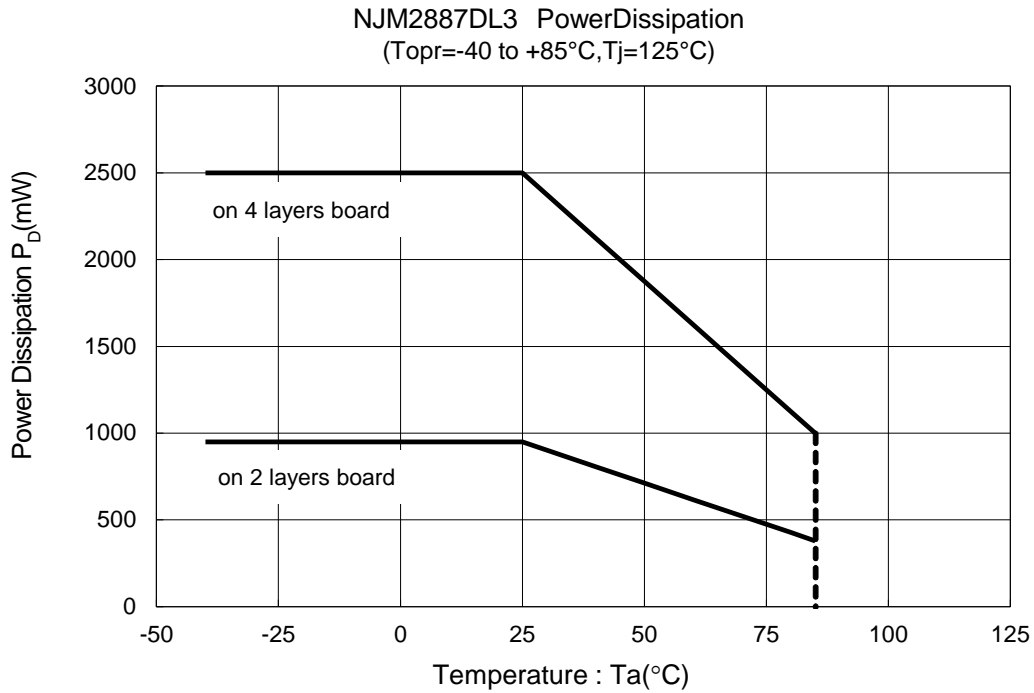

TEST CIRCUIT

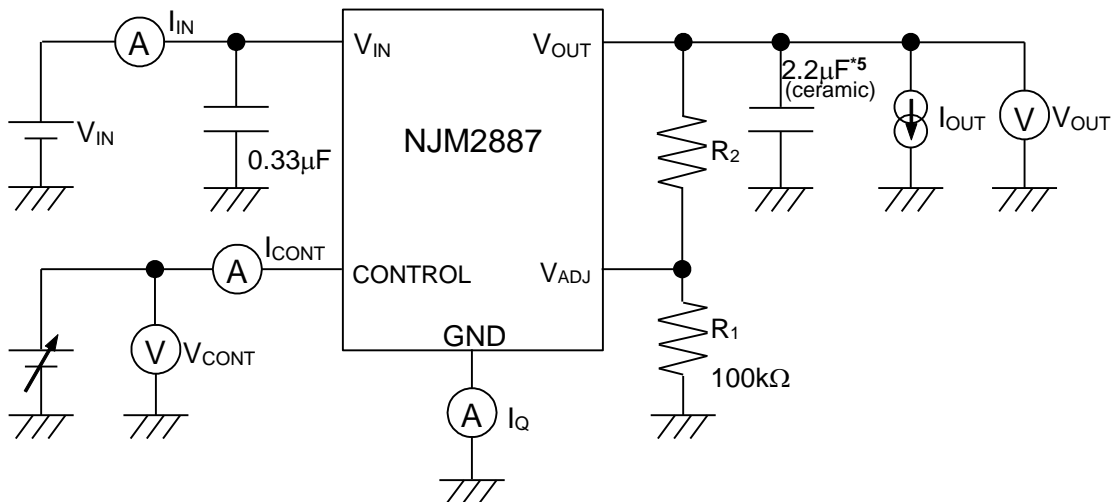

*5 $V_o \leq 2.6V$ version: $C_o = 4.7\mu F$ (ceramic)

$$V_o = V_{ref} \times (1 + R_2 / R_1)$$

The ceramic capacitor used by the output recommend the B characteristic.

■ TYPICAL APPLICATION

① In the case where ON/OFF Control is not required:

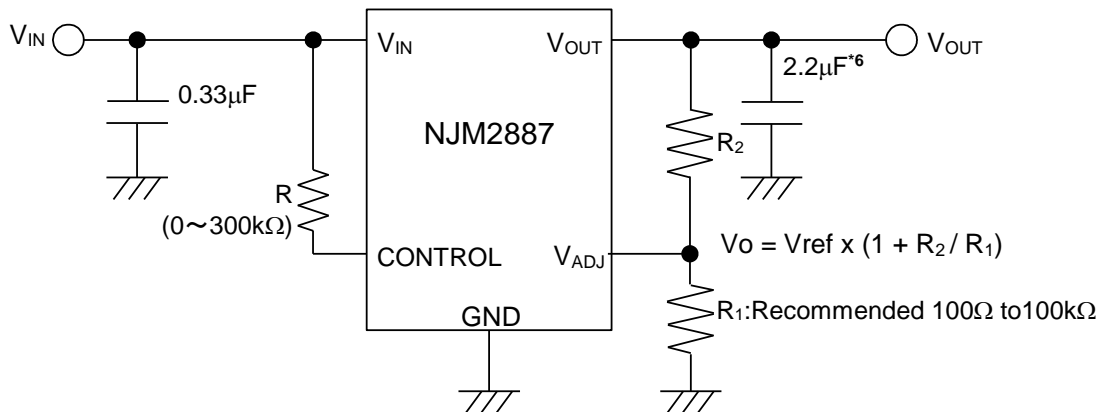

*6 $V_o \leq 2.6V$ version: $C_o = 4.7\mu F$

Connect control terminal to V_{IN} pin

② In use of ON/OFF CONTROL:

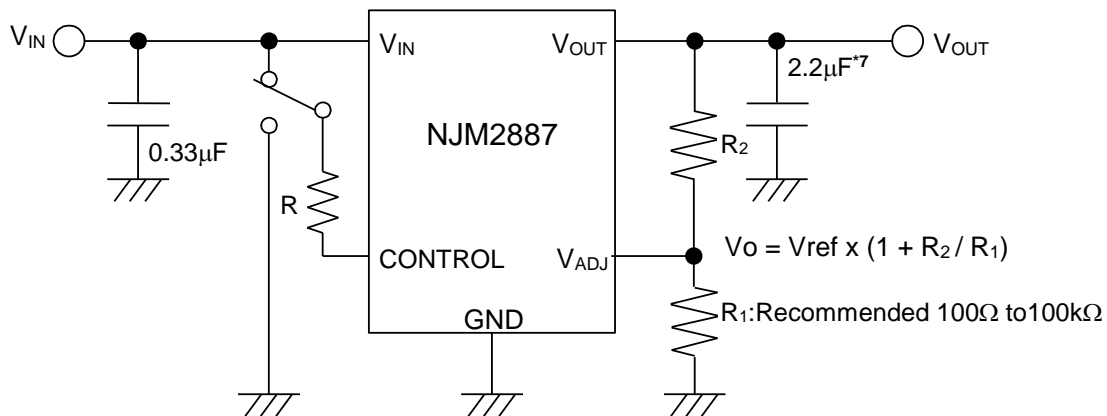

*7 $V_o \leq 2.6V$ version: $C_o = 4.7\mu F$

State of control pin:

- "H" → output is enabled.
- "L" or "open" → output is disabled.

*In the case of using a resistor "R" between V_{IN} and control.

The current flow into the control pin while the IC is ON state (I_{CONT}) can be reduced when a pull up resistor "R" is inserted between V_{IN} and the control pin.

The minimum control voltage for ON state ($V_{CONT(ON)}$) is increased due to the voltage drop caused by I_{CONT} and the resistor "R". The I_{CONT} is temperature dependence as shown in the "Control Current vs. Temperature" characteristics. Therefore, the resistor "R" should be carefully selected to ensure the control voltage exceeds the $V_{CONT(ON)}$ over the required temperature range.

*Feedback Resistor "R1".

The range of feedback resistor "R1" is recommended from 100Ω to $100k\Omega$.

When the value of feedback resistor "R1" is large, the output voltage may rise higher than the setting output voltage by leak current from V_{OUT} at high temperature.

On the other hand, a smaller feedback resistor may increase output noise voltage and quiescent current.

Regarding to reduce output noise voltage, refer to next article in addition.

③ Reduction of output noise voltage:

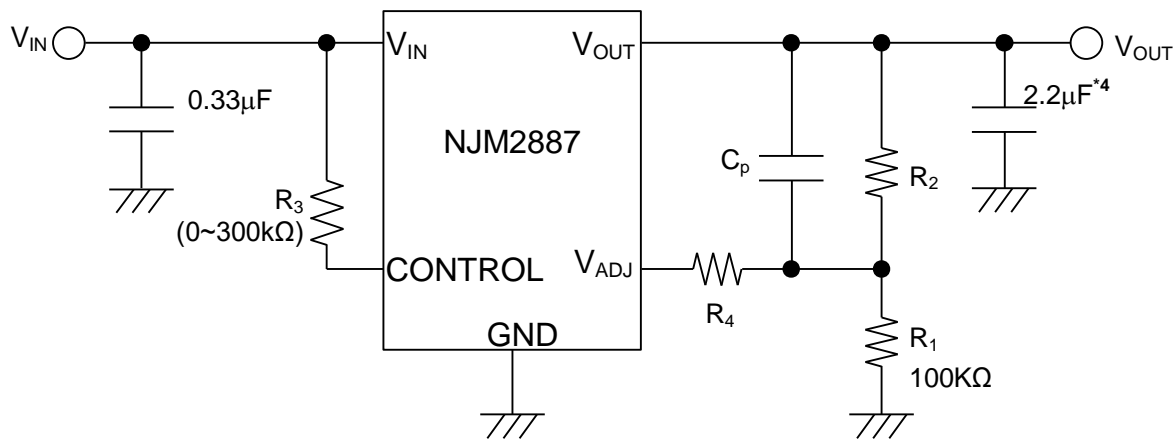

*4 $V_o \leq 2.6V$ version: $C_o = 4.7\mu F$

Output feedback resistance: R_1 , should connect near V_{ADJ} terminal.

For reduce output noise voltage, connect C_p and R_4 refer to the following table.

The example of use of C_p and R_4

Output capacity value	$R_1 = 10k\Omega$	$R_1 = 1k\Omega$	$R_1 = 100\Omega$	R_4
$C_o = 2.2\mu F$	$C_p = 100pF$	$C_p = 1nF$	$C_p = 0.01\mu F$	10kΩ or less
$C_o = 4.7\mu F$	$C_p = 680pF$	$C_p = 6.8nF$	$C_p = 0.068\mu F$	

Input Capacitor (C_{IN})

The C_{IN} prevents oscillations and reduce power supply ripple of applications when the power supply impedance is high or power supply line is long. Connecting a $0.33\mu F$ or larger C_{IN} between V_{IN} and GND pins as short path as possible.

Output Capacitor (C_o)

C_o is necessary for phase compensation of the internal error amplifier, and the capacitance value and ESR (Equivalent Series Resistance) affect the stability of the regulator. If a C_o less than recommended value or ESR out of the stable operation region is used, the stability of the internal circuit will be reduced and output noise and ringing may increase, or oscillation may occur. For stable operation, connect a $2.2\mu F$ ($C_o = 4.7\mu F$: $V_o \leq 2.6V$) or larger C_o within the stable operation region ($1\Omega \leq ESR \leq 100\Omega$) between V_{OUT} and the GND pins as short path as possible. The recommended value varies depending on the output voltage, and especially low output voltage devices may require a large capacitance; therefore, confirm the recommended value for each output voltage. As the capacitance value of C_o increases, output noise and ripple decrease, and the response to output load fluctuations also improves.

Usually, the capacitance of a capacitor decreases due to characteristic fluctuations such as frequency characteristics, temperature characteristics, and DC bias characteristic. Select the output capacitor considering these characteristic fluctuations in addition to the variations to the nominal value.

■ ELECTRICAL CHARACTERISTICS

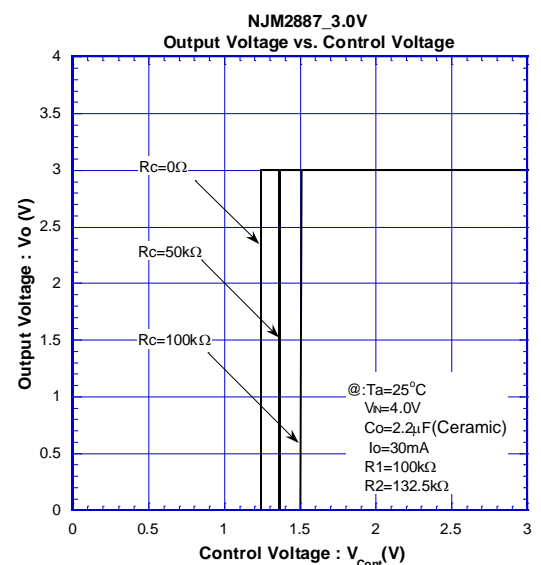
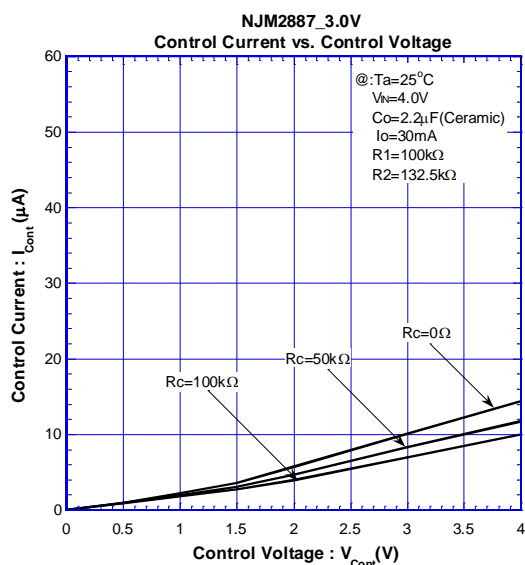
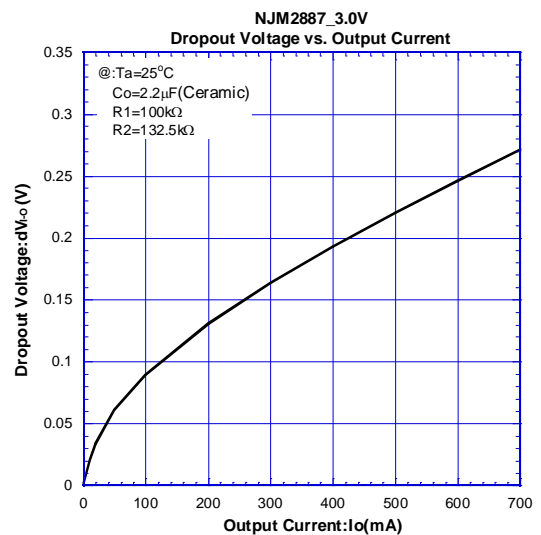
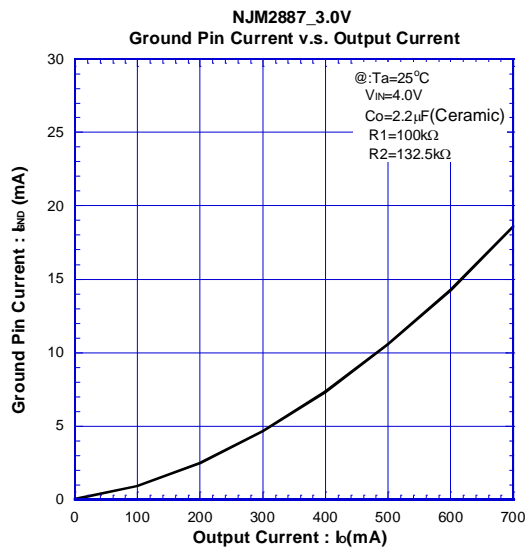
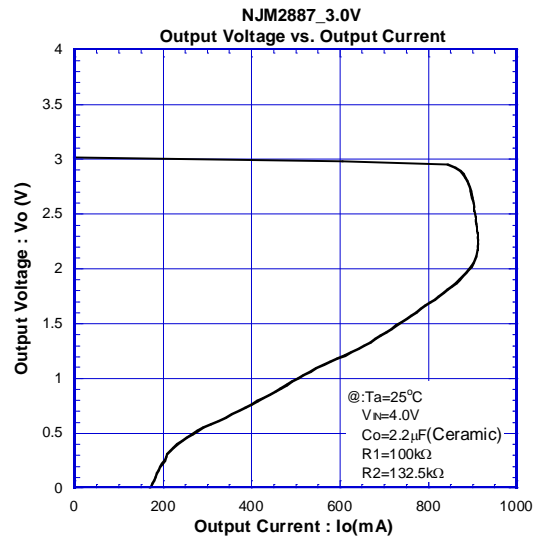
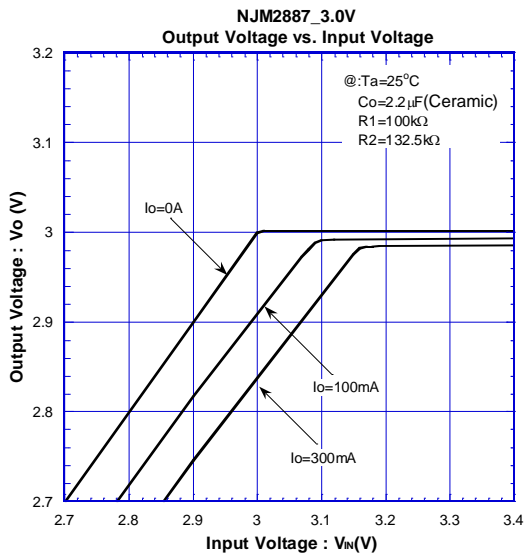

ELECTRICAL CHARACTERISTICS

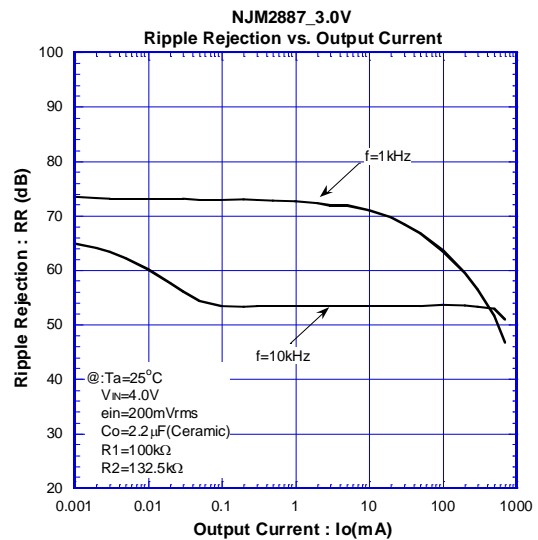
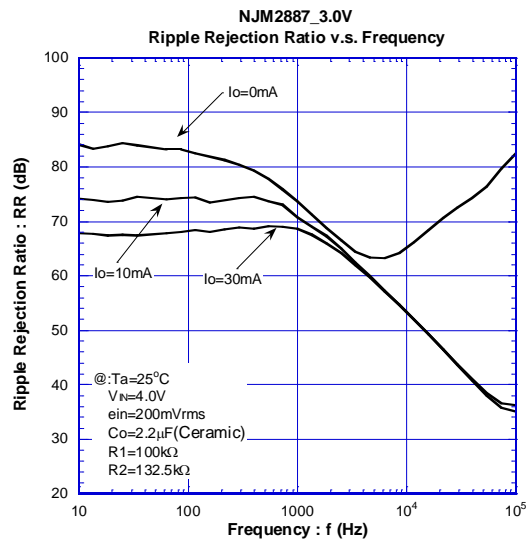
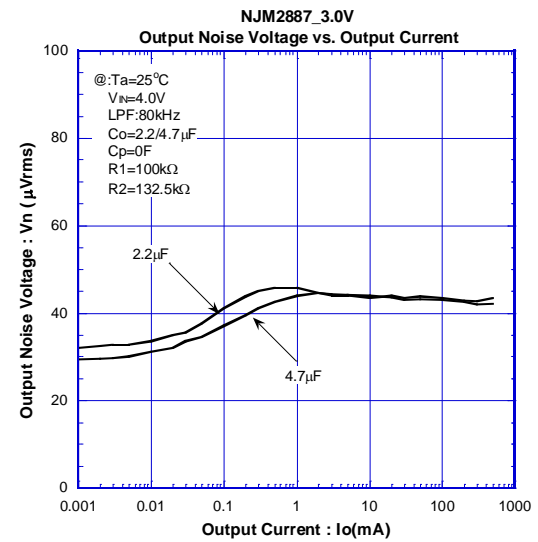
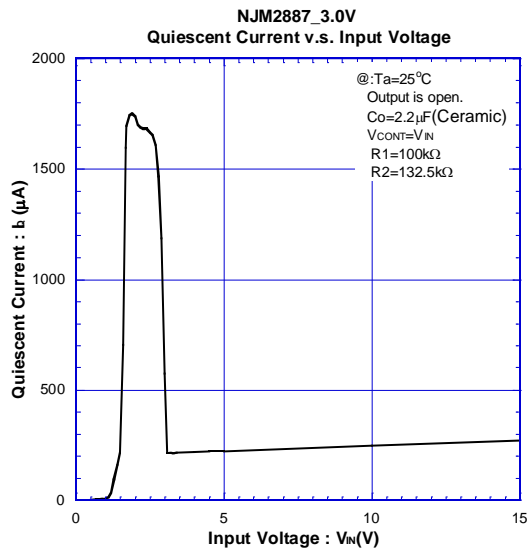
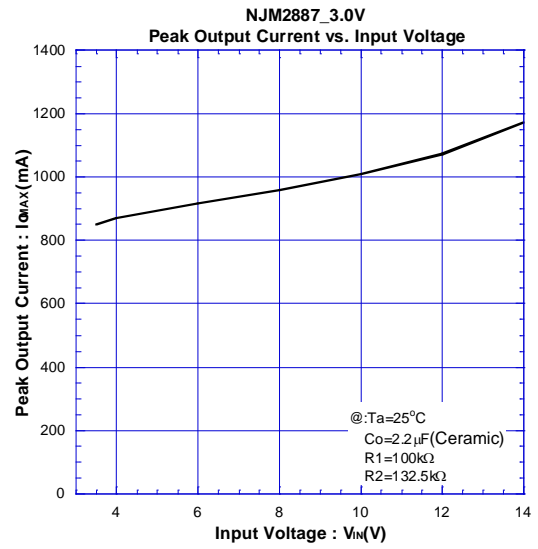
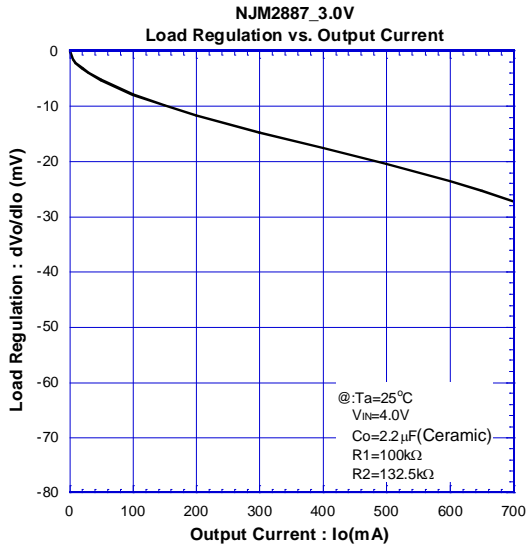

ELECTRICAL CHARACTERISTICS

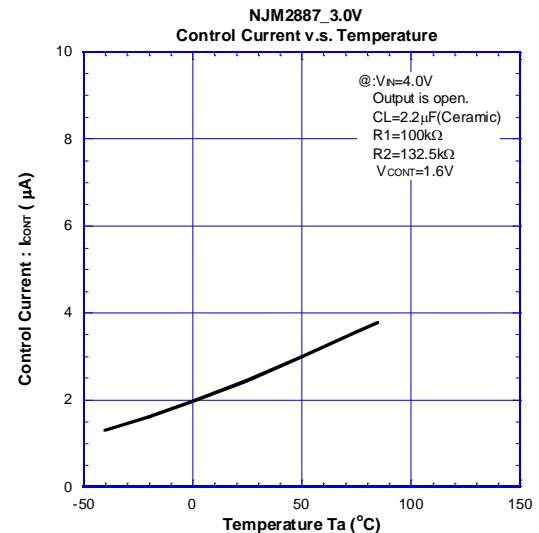
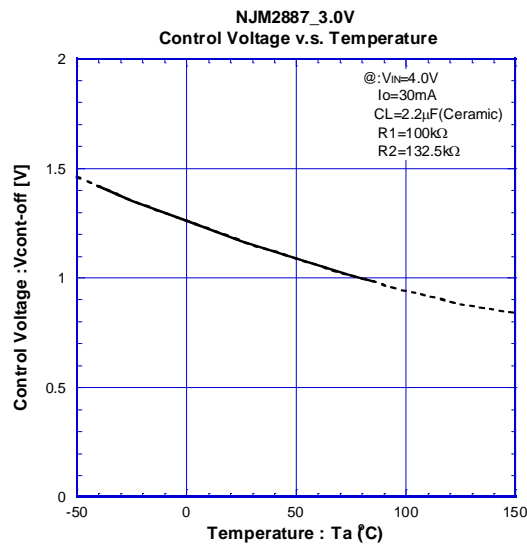
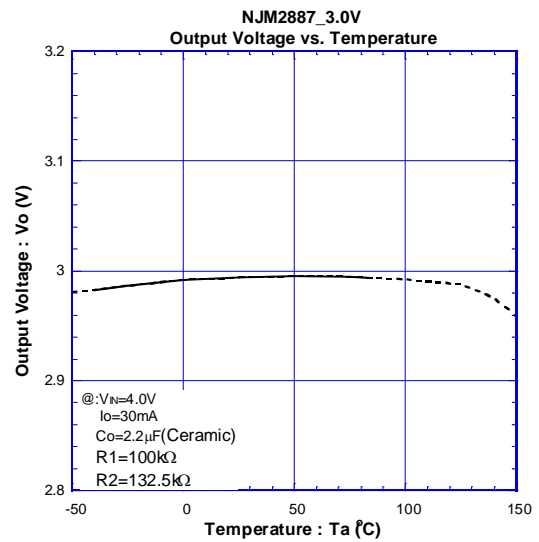
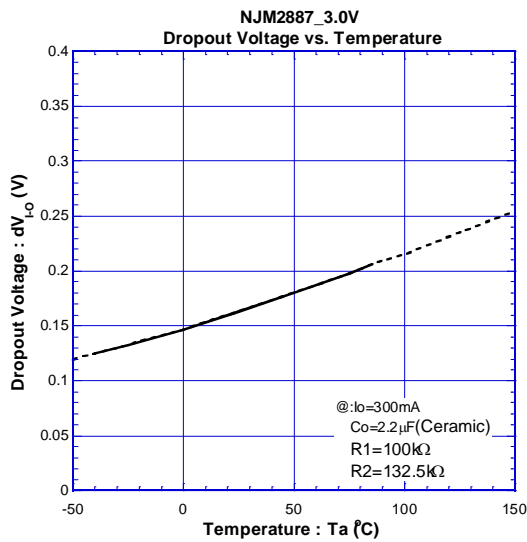
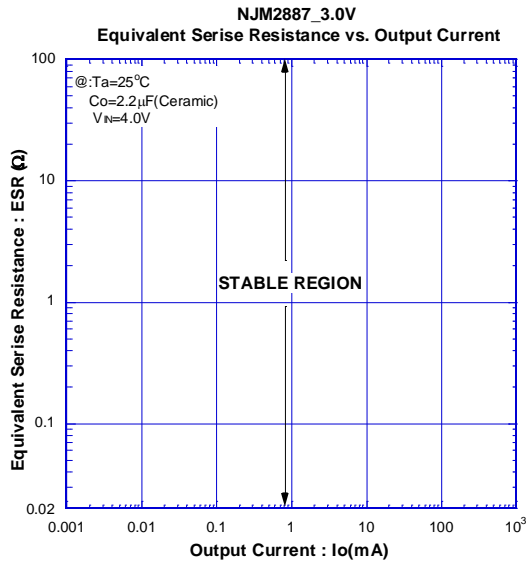

■ ELECTRICAL CHARACTERISTICS

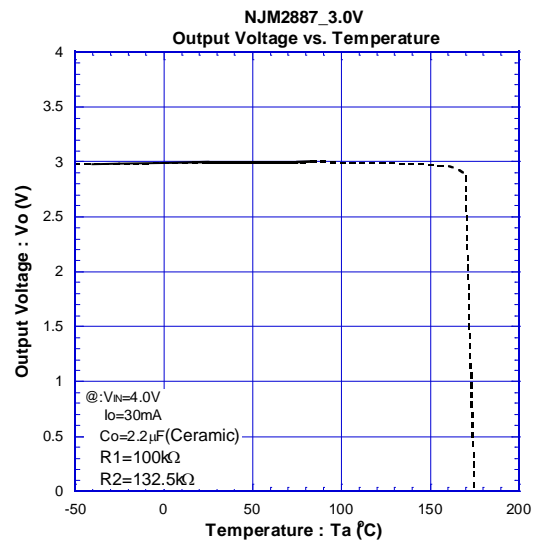
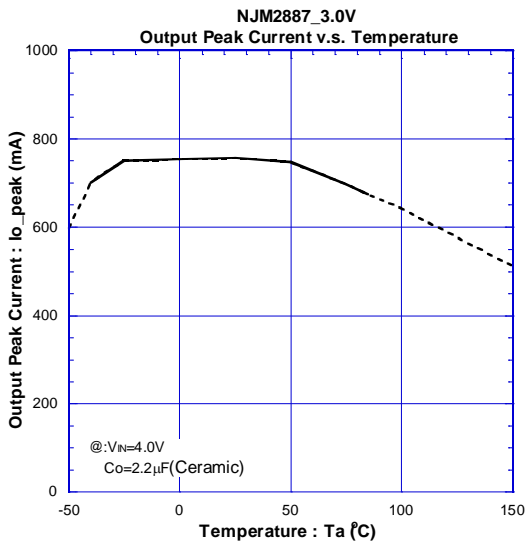
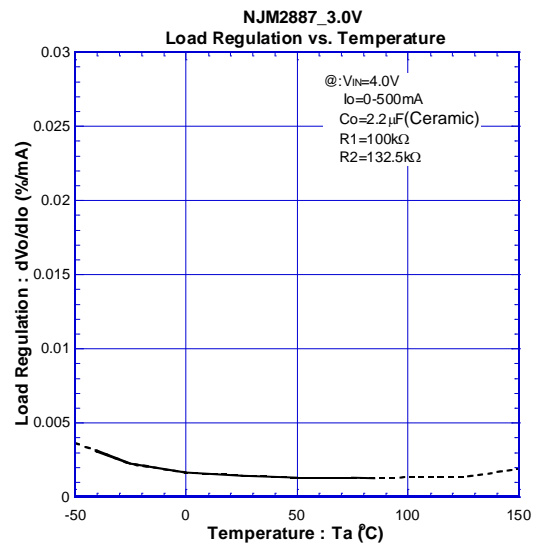
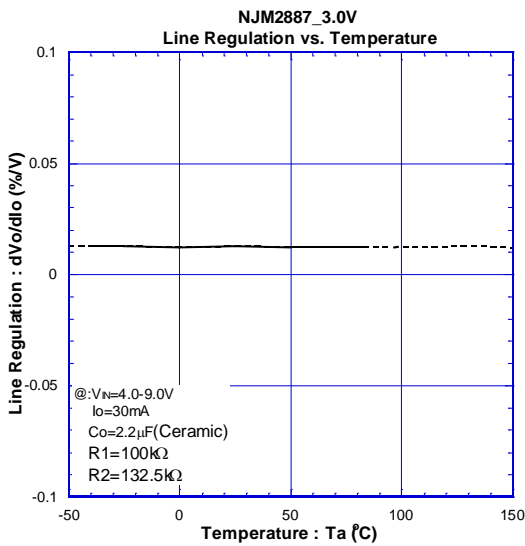
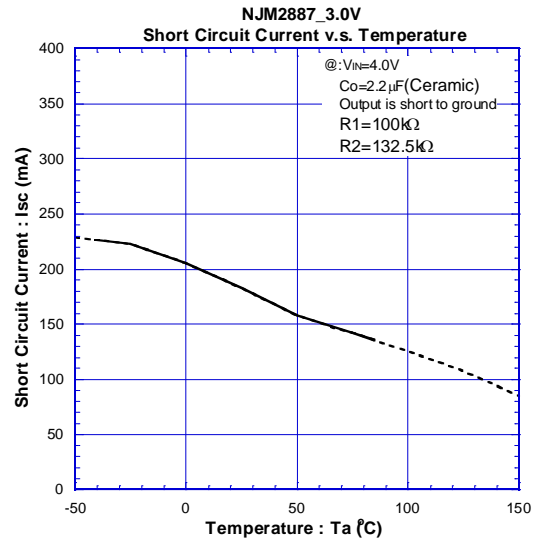
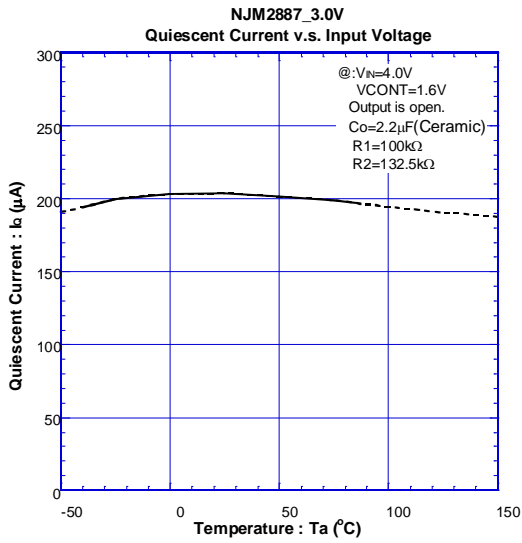

■ ELECTRICAL CHARACTERISTICS

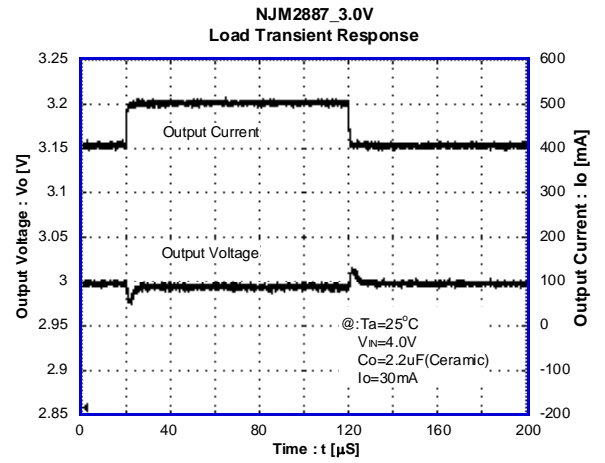
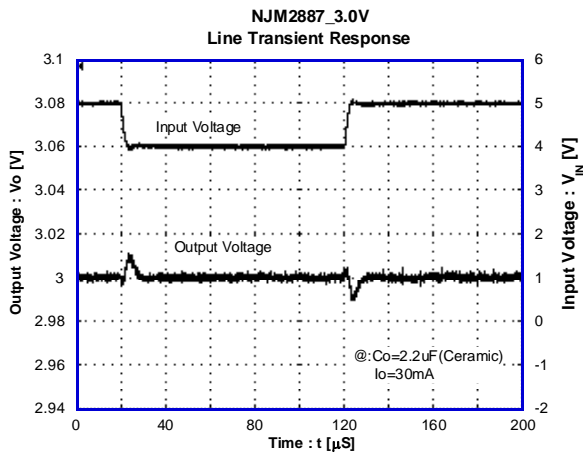
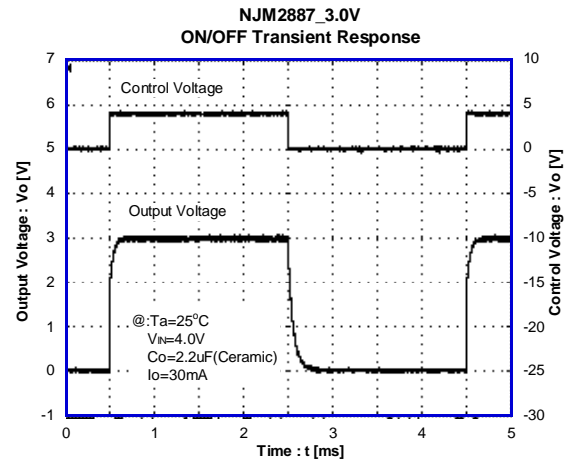
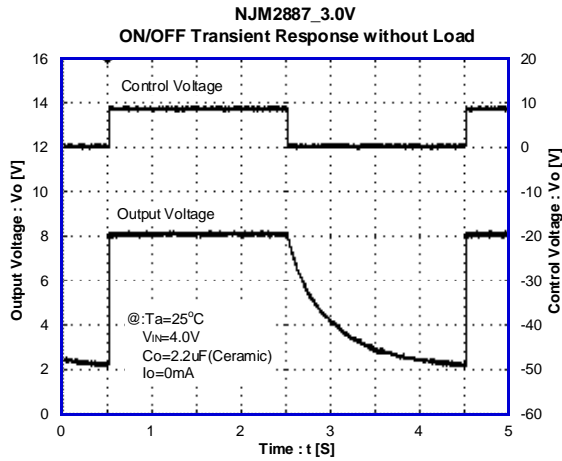

[CAUTION]

1. NJR strives to produce reliable and high quality semiconductors. NJR's semiconductors are intended for specific applications and require proper maintenance and handling. To enhance the performance and service of NJR's semiconductors, the devices, machinery or equipment into which they are integrated should undergo preventative maintenance and inspection at regularly scheduled intervals. Failure to properly maintain equipment and machinery incorporating these products can result in catastrophic system failures
2. The specifications on this datasheet are only given for information without any guarantee as regards either mistakes or omissions. The application circuits in this datasheet are described only to show representative usages of the product and not intended for the guarantee or permission of any right including the industrial property rights.
All other trademarks mentioned herein are the property of their respective companies.
3. To ensure the highest levels of reliability, NJR products must always be properly handled.
The introduction of external contaminants (e.g. dust, oil or cosmetics) can result in failures of semiconductor products.
4. NJR offers a variety of semiconductor products intended for particular applications. It is important that you select the proper component for your intended application. You may contact NJR's Sale's Office if you are uncertain about the products listed in this datasheet.
5. Special care is required in designing devices, machinery or equipment which demand high levels of reliability. This is particularly important when designing critical components or systems whose failure can foreseeably result in situations that could adversely affect health or safety. In designing such critical devices, equipment or machinery, careful consideration should be given to amongst other things, their safety design, fail-safe design, back-up and redundancy systems, and diffusion design.
6. The products listed in this datasheet may not be appropriate for use in certain equipment where reliability is critical or where the products may be subjected to extreme conditions. You should consult our sales office before using the products in any of the following types of equipment.
 - Aerospace Equipment
 - Equipment Used in the Deep Sea
 - Power Generator Control Equipment (Nuclear, steam, hydraulic, etc.)
 - Life Maintenance Medical Equipment
 - Fire Alarms / Intruder Detectors
 - Vehicle Control Equipment (Automobile, airplane, railroad, ship, etc.)
 - Various Safety Devices
7. NJR's products have been designed and tested to function within controlled environmental conditions. Do not use products under conditions that deviate from methods or applications specified in this datasheet. Failure to employ the products in the proper applications can lead to deterioration, destruction or failure of the products. NJR shall not be responsible for any bodily injury, fires or accident, property damage or any consequential damages resulting from misuse or misapplication of the products. The products are sold without warranty of any kind, either express or implied, including but not limited to any implied warranty of merchantability or fitness for a particular purpose.
8. Warning for handling Gallium and Arsenic (GaAs) Products (Applying to GaAs MMIC, Photo Reflector). These products use Gallium (Ga) and Arsenic (As) which are specified as poisonous chemicals by law. For the prevention of a hazard, do not burn, destroy, or process chemically to make them as gas or power. When the product is disposed of, please follow the related regulation and do not mix this with general industrial waste or household waste.
9. The product specifications and descriptions listed in this datasheet are subject to change at any time, without notice.



Mouser Electronics

Authorized Distributor

Click to View Pricing, Inventory, Delivery & Lifecycle Information:

[Nisshinbo Micro Devices:](#)

[NJM2887DL3-TE1](#)