

NPN General-Purpose Amplifier

2N5551

Description

This device is designed for general-purpose high-voltage amplifiers and gas discharge display drivers.

Features

- These Devices are Pb-Free, Halogen Free/BFR Free and are RoHS Compliant

ABSOLUTE MAXIMUM RATINGS (Note 1)

Symbol	Parameter	Value	Unit
V_{CEO}	Collector-Emmitter Voltage	160	V
V_{CBO}	Collector-Base Voltage	180	V
V_{EBO}	Emitter-Base Voltage	6	V
I_C	Collector Current - Continuous	600	mA
T_J, T_{STG}	Operating and Storage Temperature (Note 2)	-55 to + 150	°C

Stresses exceeding those listed in the Maximum Ratings table may damage the device. If any of these limits are exceeded, device functionality should not be assumed, damage may occur and reliability may be affected.

1. These ratings are limiting values above which the serviceability of any semiconductor device may be impaired.
2. These ratings are based on a maximum junction temperature of 150°C. These are steady-state limits. **onsemi** should be consulted on applications involving pulsed or low-duty cycle operations.

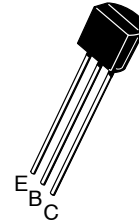

TO-92-3
 4.825x4.76
 CASE 135AN

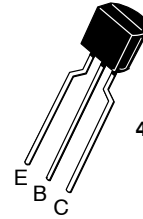

TO-92-3
 4.83x4.76 LEADFORMED
 CASE 135AR

MARKING DIAGRAM

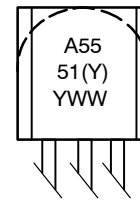

- A = Assembly Location
- 5551(Y) = Specific Device Code
- Y = Year
- WW = Work Week

ORDERING INFORMATION

See detailed ordering and shipping information on page 5 of this data sheet.

NOTE: Some of the devices on this data sheet have been **DISCONTINUED**. Please refer to the table on page 5.

2N5551

THEMAL CHARACTERISTICS ($T_A = 25^\circ\text{C}$ unless otherwise noted) (Note 3)

Symbol	Characteristic	Max	Unit
P_D	Total Device Dissipation	625	mW
	Derate Above 25°C	5.0	mW/ $^\circ\text{C}$
$R_{\theta JC}$	Thermal Resistance, Junction to Case	83.3	$^\circ\text{C}/\text{W}$
$R_{\theta JA}$	Thermal Resistance, Junction to Ambient	200	$^\circ\text{C}/\text{W}$

ELECTRICAL CHARACTERISTICS ($T_A = 25^\circ\text{C}$ unless otherwise noted) (Note 4)

Symbol	Parameter	Test Conditions	Min	Max	Unit
$V_{(BR)CEO}$	Collector–Emitter Breakdown Voltage	$I_C = 1.0\text{ mA}, I_B = 0$	160		V
$V_{(BR)CBO}$	Collector–Base Breakdown Voltage	$I_C = 100\ \mu\text{A}, I_E = 0$	180		V
$V_{(BR)EBO}$	Emitter–Base Breakdown Voltage	$I_E = 10\ \mu\text{A}, I_C = 0$	6.0		V
I_{CBO}	Collector Cut–Off Current	$V_{CB} = 120\text{ V}, I_E = 0$		50	nA
		$V_{CB} = 120\text{ V}, I_E = 0\text{ V}, T_A = 100^\circ\text{C}$		50	μA
I_{EBO}	Emitter Cut–Off Current	$V_{EB} = 4.0\text{ V}, I_C = 0$		50	nA

ON CHARACTERISTICS

h_{FE}	DC Current Gain	$I_C = 1.0\text{ mA}, V_{CE} = 5.0\text{ V}$	80		
		$I_C = 10\text{ mA}, V_{CE} = 5.0\text{ V}$	80	250	
		$I_C = 10\text{ mA}, V_{CE} = 5.0\text{ V}$ (for 2N5551YBU, 2N5551YTA)	180	240	
		$I_C = 50\text{ mA}, V_{CE} = 5.0\text{ V}$	30		
$V_{CE(sat)}$	Collector–Emitter Saturation Voltage	$I_C = 10\text{ mA}, I_B = 1.0\text{ mA}$		0.15	V
		$I_C = 50\text{ mA}, I_B = 5.0\text{ mA}$		0.20	V
$V_{BE(sat)}$	Base–Emitter On Voltage	$I_C = 10\text{ mA}, I_B = 1.0\text{ mA}$		1.0	V
		$I_C = 50\text{ mA}, I_B = 5.0\text{ mA}$		1.0	V

SMALL–SIGNAL CHARACTERISTICS

f_T	Current Gain Bandwidth Product	$I_C = 10\text{ mA}, V_{CE} = 10\text{ V}, f = 100\text{ MHz}$	100		MHz
C_{obo}	Output Capacitance	$V_{CB} = 10\text{ V}, I_E = 0, f = 1.0\text{ MHz}$		6.0	pF
C_{ibo}	Input Capacitance	$V_{BE} = 0.5\text{ V}, I_C = 0, f = 1.0\text{ MHz}$		20	pF
H_{fe}	Small–Signal Current Gain	$I_C = 1.0\text{ mA}, V_{CE} = 10\text{ V}, f = 1.0\text{ kHz}$	50	250	
NF	Noise Figure	$I_C = 250\ \mu\text{A}, V_{CE} = 5.0\text{ V}, R_S = 1.0\text{ k}\Omega, f = 10\text{ Hz to }15.7\text{ kHz}$		8.0	dB

Product parametric performance is indicated in the Electrical Characteristics for the listed test conditions, unless otherwise noted. Product performance may not be indicated by the Electrical Characteristics if operated under different conditions.

3. PCB board size FR–4 $76 \times 114 \times 0.6\text{ T mm}^3$ (3.0 inch x 4.5 inch x 0.062 inch) with minimum land pattern size.

4. Pulse test: pulse width $\leq 300\ \mu\text{s}$, duty cycle $\leq 2.0\%$.

TYPICAL PERFORMANCE CHARACTERISTICS

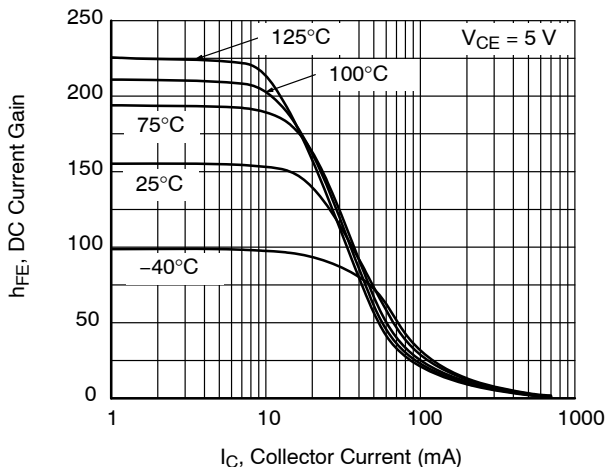

Figure 1. Typical Pulsed Current Gain vs. Collector Current

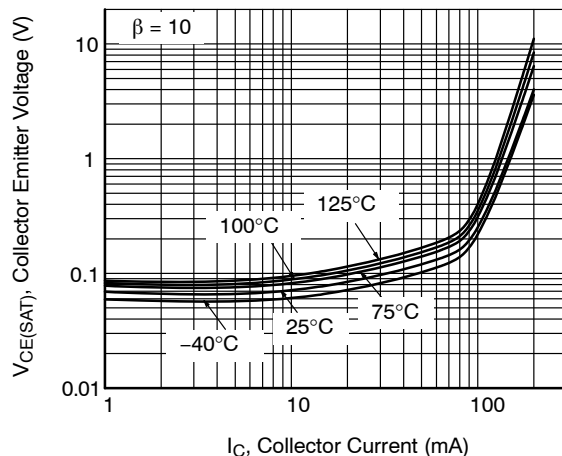

Figure 2. Collector-Emitter Saturation Voltage vs. Collector Current

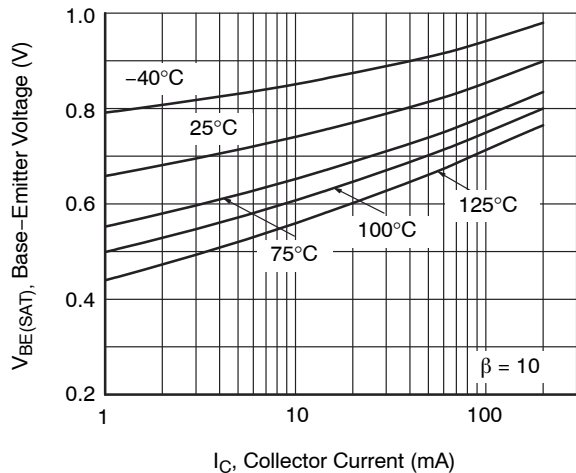

Figure 3. Base-Emitter Saturation Voltage vs. Collector Current

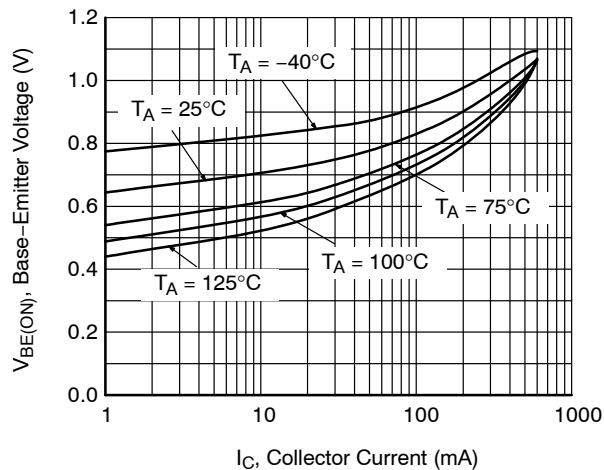

Figure 4. Base-Emitter On Voltage vs. Collector Current

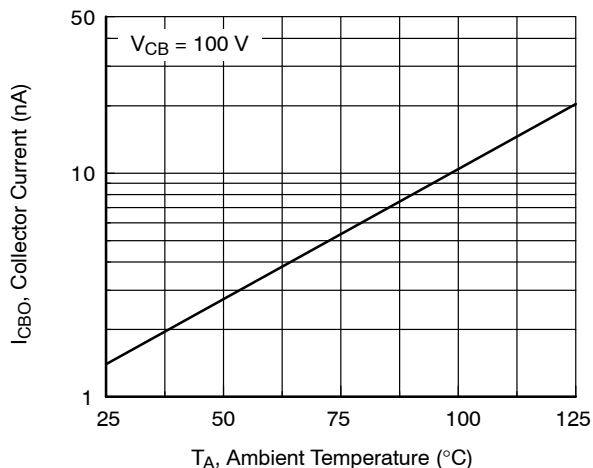

Figure 5. Collector Cut-Off Current vs. Ambient Temperature

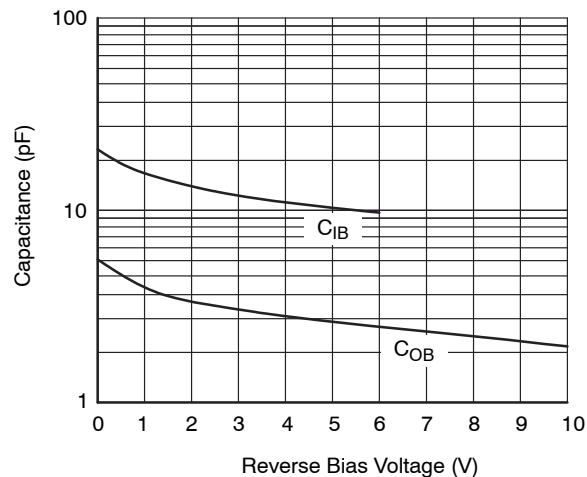

Figure 6. Input and Output Capacitance vs. Reverse Voltage

TYPICAL PERFORMANCE CHARACTERISTICS (CONTINUED)

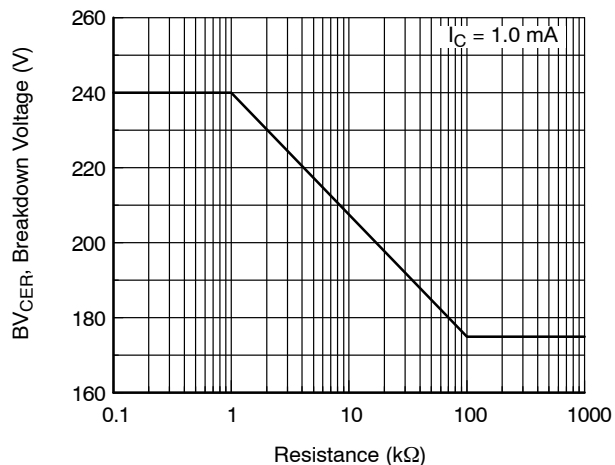

Figure 7. Collector-Emitter Breakdown Voltage with Resistance between Emitter-Base

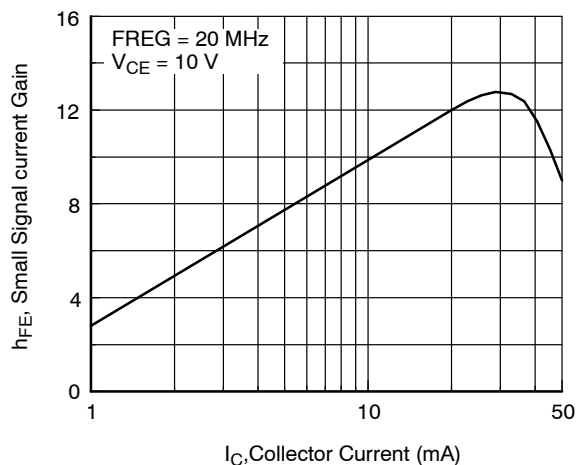

Figure 8. Small Signal Current Gain vs. Collector Current

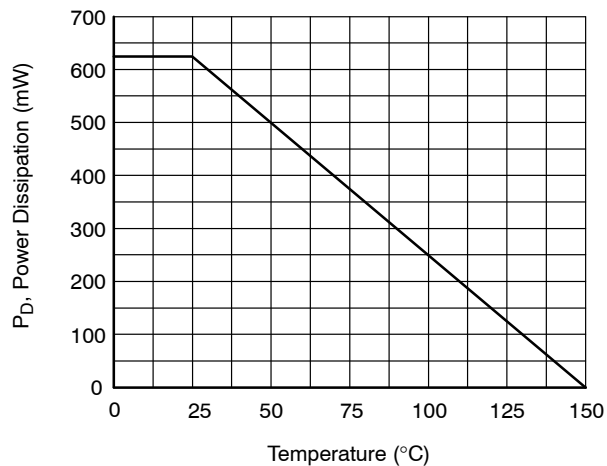

Figure 9. Power Dissipation vs. Ambient Temperature

2N5551

ORDERING INFORMATION (Note 5)

Part Number	Top Mark	Package	Shipping†
2N5551TA	5551	TO-92-3, Case 135AR (Pb-Free)	2000 / Ammo Pack
2N5551TFR	5551	TO-92-3, Case 135AR (Pb-Free)	2000 / Tape & Reel
2N5551TF	5551	TO-92-3, Case 135AR (Pb-Free)	2000 / Tape & Reel
2N5551BU	5551	TO-92-3, Case 135AN (Pb-Free)	10000 / Bulk Bag
2N5551YBU	5551Y	TO-92-3, Case 135AN (Pb-Free)	10000 / Bulk Bag

DISCONTINUED (Note 6)

2N5551CTA	5551	TO-92-3, Case 135AR (Pb-Free)	2000 / Ammo Pack
2N5551YTA	5551Y	TO-92-3, Case 135AR (Pb-Free)	2000 / Ammo Pack

†For information on tape and reel specifications, including part orientation and tape sizes, please refer to our Tape and Reel Packaging Specifications Brochure, BRD8011/D.

5. Suffix "-Y" means h_{FE} 180-240 in 2N5551 (Test condition: $I_C = 10$ mA, $V_{CE} = 5.0$ V)

6. **DISCONTINUED:** These devices are not recommended for new design. Please contact your **onsemi** representative for information. The most current information on these devices may be available on www.onsemi.com.

TO-92 3 4.825x4.76
CASE 135AN
ISSUE O

DATE 31 JUL 2016

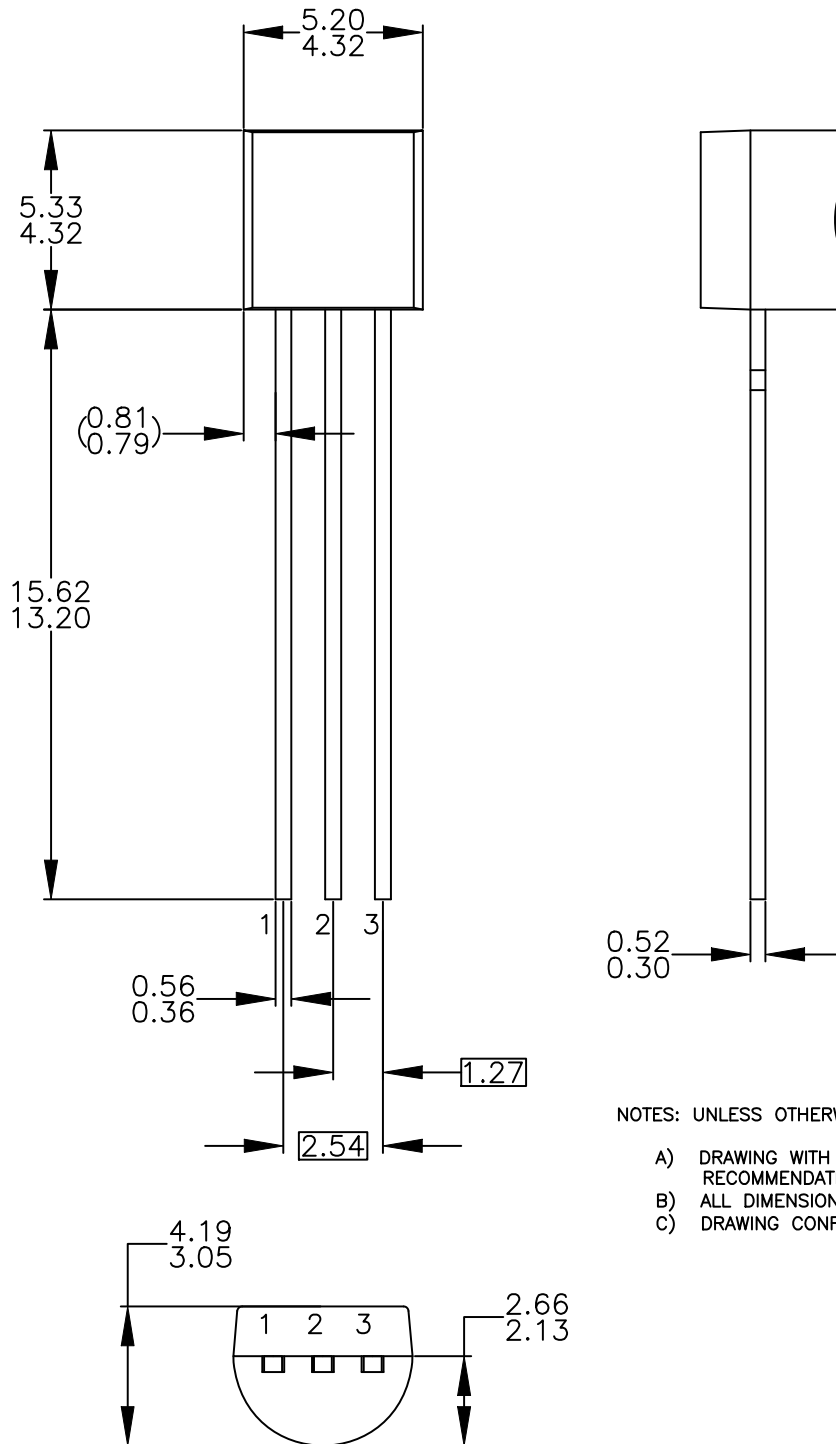

NOTES: UNLESS OTHERWISE SPECIFIED

- A) DRAWING WITH REFERENCE TO JEDEC TO-92 RECOMMENDATIONS.
- B) ALL DIMENSIONS ARE IN MILLIMETERS.
- C) DRAWING CONFORMS TO ASME Y14.5M-2009.

DOCUMENT NUMBER:	98AON13880G	Electronic versions are uncontrolled except when accessed directly from the Document Repository. Printed versions are uncontrolled except when stamped "CONTROLLED COPY" in red.
DESCRIPTION:	TO-92 3 4.825X4.76	PAGE 1 OF 1

onsemi and ONSEMI are trademarks of Semiconductor Components Industries, LLC dba onsemi or its subsidiaries in the United States and/or other countries. onsemi reserves the right to make changes without further notice to any products herein. onsemi makes no warranty, representation or guarantee regarding the suitability of its products for any particular purpose, nor does onsemi assume any liability arising out of the application or use of any product or circuit, and specifically disclaims any and all liability, including without limitation special, consequential or incidental damages. onsemi does not convey any license under its patent rights nor the rights of others.

TO-92 3 4.83x4.76 LEADFORMED
CASE 135AR
ISSUE O

DATE 30 SEP 2016

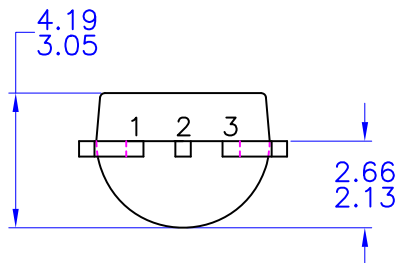
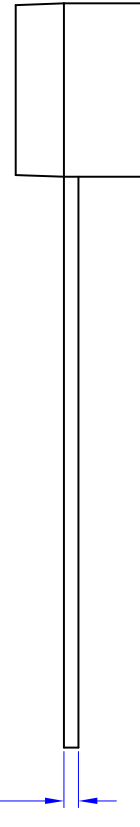
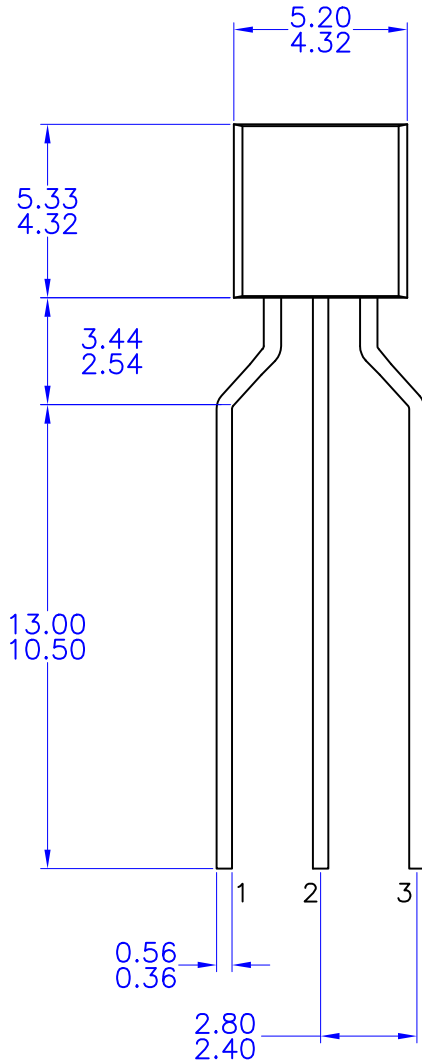

NOTES: UNLESS OTHERWISE SPECIFIED

- A) DRAWING WITH REFERENCE TO JEDEC TO-92 RECOMMENDATIONS.
- B) ALL DIMENSIONS ARE IN MILLIMETERS.
- C) DRAWING CONFORMS TO ASME Y14.5M-1994

DOCUMENT NUMBER:	98AON13879G	Electronic versions are uncontrolled except when accessed directly from the Document Repository. Printed versions are uncontrolled except when stamped "CONTROLLED COPY" in red.
DESCRIPTION:	TO-92 3 4.83X4.76 LEADFORMED	PAGE 1 OF 1

onsemi and ONSEMI are trademarks of Semiconductor Components Industries, LLC dba onsemi or its subsidiaries in the United States and/or other countries. onsemi reserves the right to make changes without further notice to any products herein. onsemi makes no warranty, representation or guarantee regarding the suitability of its products for any particular purpose, nor does onsemi assume any liability arising out of the application or use of any product or circuit, and specifically disclaims any and all liability, including without limitation special, consequential or incidental damages. onsemi does not convey any license under its patent rights nor the rights of others.

onsemi, **Onsemi**, and other names, marks, and brands are registered and/or common law trademarks of Semiconductor Components Industries, LLC dba "**onsemi**" or its affiliates and/or subsidiaries in the United States and/or other countries. **onsemi** owns the rights to a number of patents, trademarks, copyrights, trade secrets, and other intellectual property. A listing of **onsemi**'s product/patent coverage may be accessed at www.onsemi.com/site/pdf/Patent-Marking.pdf. **onsemi** reserves the right to make changes at any time to any products or information herein, without notice. The information herein is provided "as-is" and **onsemi** makes no warranty, representation or guarantee regarding the accuracy of the information, product features, availability, functionality, or suitability of its products for any particular purpose, nor does **onsemi** assume any liability arising out of the application or use of any product or circuit, and specifically disclaims any and all liability, including without limitation special, consequential or incidental damages. Buyer is responsible for its products and applications using **onsemi** products, including compliance with all laws, regulations and safety requirements or standards, regardless of any support or applications information provided by **onsemi**. "Typical" parameters which may be provided in **onsemi** data sheets and/or specifications can and do vary in different applications and actual performance may vary over time. All operating parameters, including "Typicals" must be validated for each customer application by customer's technical experts. **onsemi** does not convey any license under any of its intellectual property rights nor the rights of others. **onsemi** products are not designed, intended, or authorized for use as a critical component in life support systems or any FDA Class 3 medical devices or medical devices with a same or similar classification in a foreign jurisdiction or any devices intended for implantation in the human body. Should Buyer purchase or use **onsemi** products for any such unintended or unauthorized application, Buyer shall indemnify and hold **onsemi** and its officers, employees, subsidiaries, affiliates, and distributors harmless against all claims, costs, damages, and expenses, and reasonable attorney fees arising out of, directly or indirectly, any claim of personal injury or death associated with such unintended or unauthorized use, even if such claim alleges that **onsemi** was negligent regarding the design or manufacture of the part. **onsemi** is an Equal Opportunity/Affirmative Action Employer. This literature is subject to all applicable copyright laws and is not for resale in any manner.

ADDITIONAL INFORMATION

TECHNICAL PUBLICATIONS:

Technical Library: www.onsemi.com/design/resources/technical-documentation
onsemi Website: www.onsemi.com

ONLINE SUPPORT: www.onsemi.com/support

For additional information, please contact your local Sales Representative at www.onsemi.com/support/sales