

DUAL OPERATIONAL AMPLIFIER

■ GENERAL DESCRIPTION

The NJM2100 is a low voltage operation and low saturation output voltage ($\pm 2.0V_{P-P}$ at supply voltage $\pm 2.5V$) operational amplifier. It is suitable for digital audio apparatus such as handy type CD, radio cassette CD, and portable DAT that are required 5V single supply operation and high output voltage.

■ FEATURES

- Single Supply Operation
- Operating Voltage ($\pm 1.0V \sim \pm 3.5V$)
- Low Saturation Output Voltage
- High Slew Rate ($4V/\mu s$ typ.)
- Package Outline
DIP8, SIP8, DMP8, SSOP8
SOP8 JEDEC 150mil
- Bipolar Technology

■ PIN CONFIGURATION

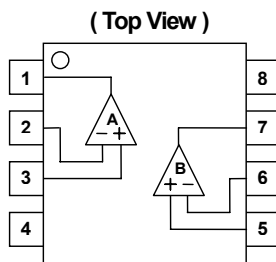

NJM2100D
NJM2100M
NJM2100E
NJM2100V

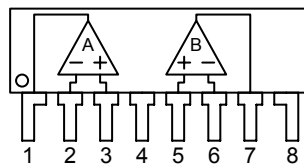

NJM2100L

- PIN
FUNCTION
1. A OUTPUT
 2. A -INPUT
 3. A +INPUT
 4. V^-
 5. B +INPUT
 6. B -INPUT
 7. B OUTPUT
 8. V^+

■ PACKAGE OUTLINE



NJM2100D
(DIP8)

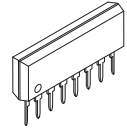

NJM2100L
(SIP8)



NJM2100M
(DMP8)



NJM2100E
(SOP8)



NJM2100V
(SSOP8)

■ EQUIVALENT CIRCUIT (1/2 Shown)

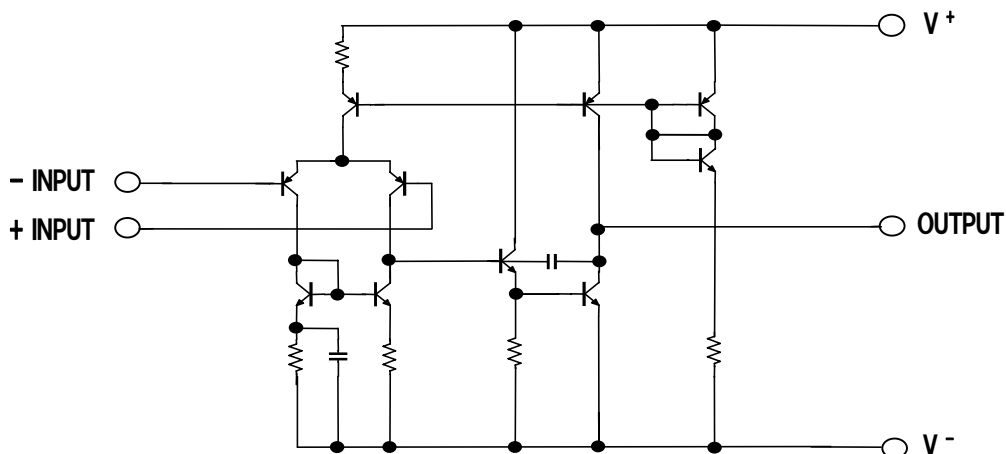

NJM2100

■ ABSOLUTE MAXIMUM RATINGS

(Ta=25°C)

PARAMETER	SYMBOL	RATINGS	UNIT
Supply Voltage	V^+ / V^-	± 3.5	V
Differential Input Voltage	V_{ID}	± 7	V
Input Voltage	V_{IC}	± 3.5	V
Power Dissipation	P_D	(DIP8) 500 (DMP8) 300 (SOP8) 300 (SSOP8) 250 (SIP8) 800	mW
Operating Temperature Range	T_{opr}	-40~+85	°C
Storage Temperature Range	T_{stg}	-40~+125	°C

■ ELECTRICAL CHARACTERISTICS

(Ta=25°C, $V^+=5V$)

PARAMETER	SYMBOL	TEST CONDITION	MIN.	TYP.	MAX.	UNIT
Input Offset Voltage	V_{IO}	$R_S \leq 10k\Omega$	-	1	6	mV
Input Bias Current	I_{IB}		-	100	300	nA
Large Signal Voltage Gain	A_V	$R_L \geq 10k\Omega$	60	80	-	dB
Maximum Output Voltage Swing	V_{OM}	$R_L \geq 2.5k\Omega$	± 2	± 2.2	-	V
Input Common Mode Voltage Range	V_{ICM}		± 1.5	-	-	V
Common Mode Rejection Ratio	CMR		60	74	-	dB
Supply Voltage Rejection Ratio	SVR		60	80	-	dB
Operating Current	I_{CC}	$V_{IN}=0, R_L=\infty$	-	3.5	5	mA
Slew Rate	SR	$A_V=1, V_{IN}=\pm 1V$	-	4	-	V/ μ s
Gain Bandwidth Product	GB	$f=10kHz$	-	12	-	MHz

(Note1) Applied circuit voltage gain is desired to operate within the range of 3dB to 30 dB.

(Note2) Special care being required for input common mode voltage range and the oscillation due to the capacitive load when operating on voltage follower.

(Note3) Special care being required for the oscillation, yet having the gain when the supply voltage is applied at more than 5V (single supply voltage 5V).

■ TYPICAL CHARACTERISTICS

Open Loop Voltage Gain vs. Frequency

($V^+/V^- = \pm 2.5V$, $T_a = 25^\circ C$)

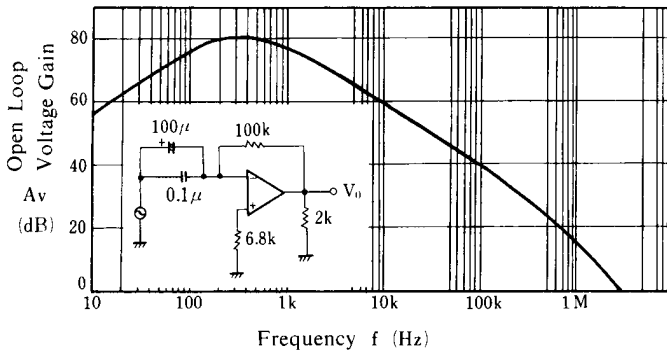

Maximum Output Voltage Swing vs. Load Resistance

($V^+/V^- = \pm 2.5V$, $T_a = 25^\circ C$)

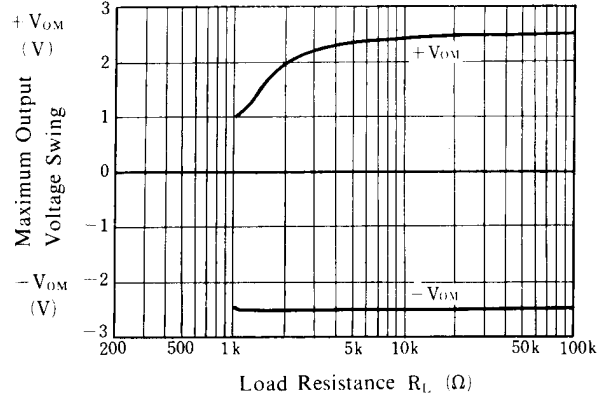

Total Harmonic Distortion vs. Output Voltage

($V^+/V^- = \pm 3V$, $R_L = 4k\Omega$, Gain = 10dB, $T_a = 25^\circ C$)

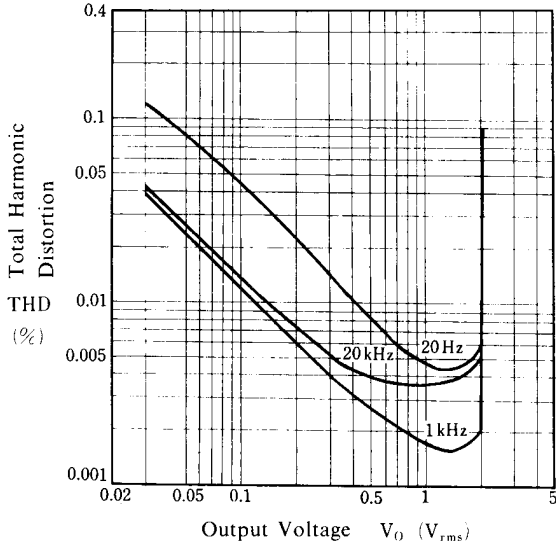

Equivalent Input Noise Voltage vs. Source Resistance

($V^+/V^- = \pm 3V$, JISA, $T_a = 25^\circ C$)

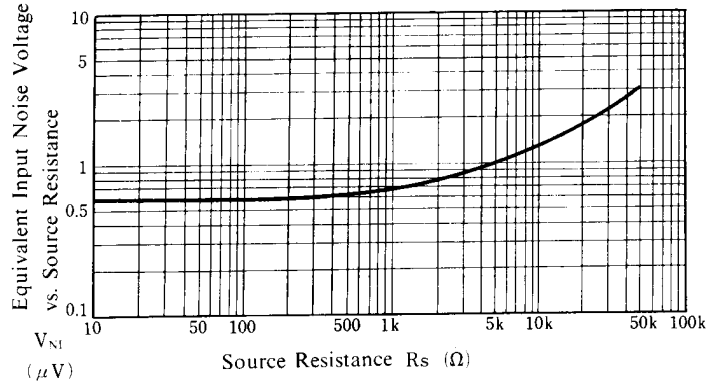

Operating Current vs. Temperature

($V^+/V^- = \pm 2.5V$)

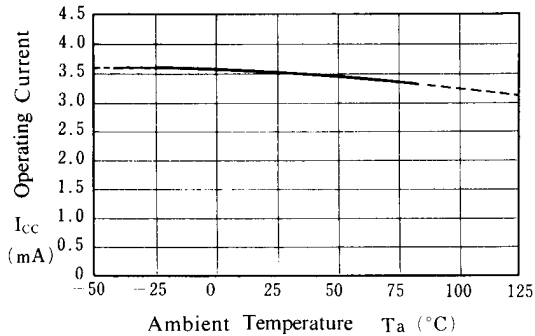

Maximum Output Voltage Swing vs. Temperature

($V^+/V^- = \pm 2.5V$, $R_L = 2.5k\Omega$)

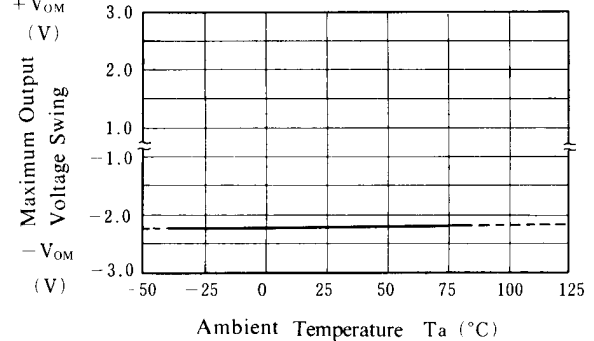

■ TYPICAL CHARACTERISTICS

Input Offset Voltage vs. Temperature

($V^+ / V^- = \pm 2.5V$)

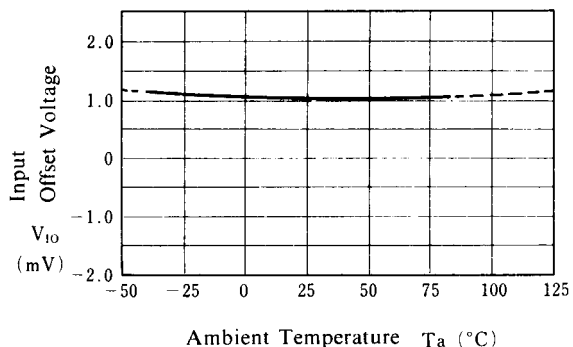

Input Bias Current vs. Temperature

($V^+ \cdot V^- = \pm 2.5V$)

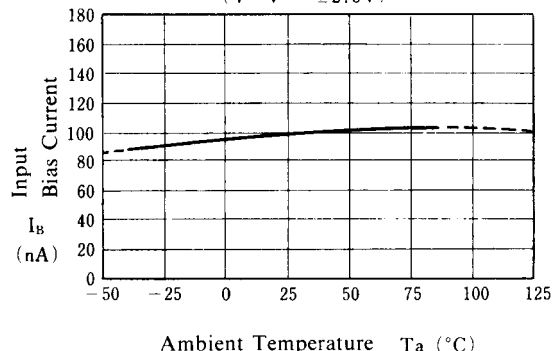

Maximum Output Voltage Swing vs. Operating Voltage

($R_L = 2.5k\Omega, T_a = 25^\circ C$)

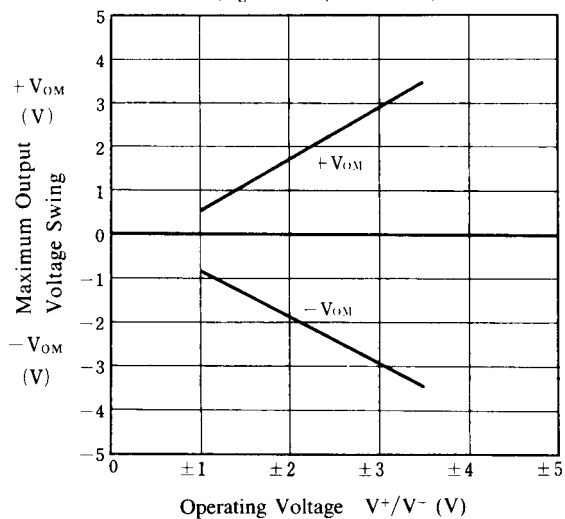

Operating Current vs. Operating Voltage

($T_a = 25^\circ C$)

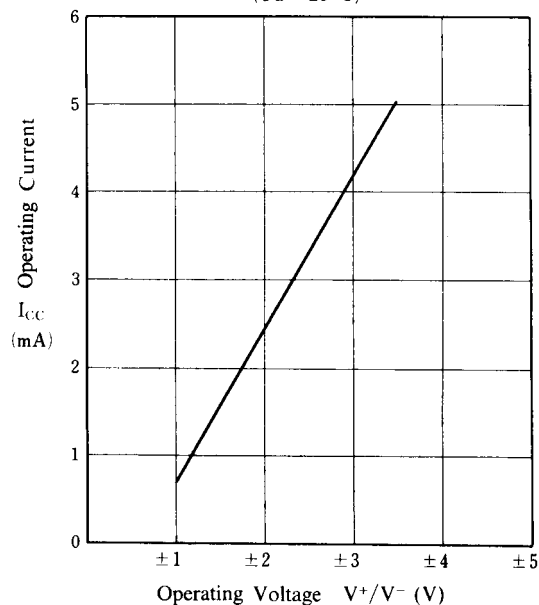

Input Offset Voltage vs. Operating Voltage

($T_a = 25^\circ C$)

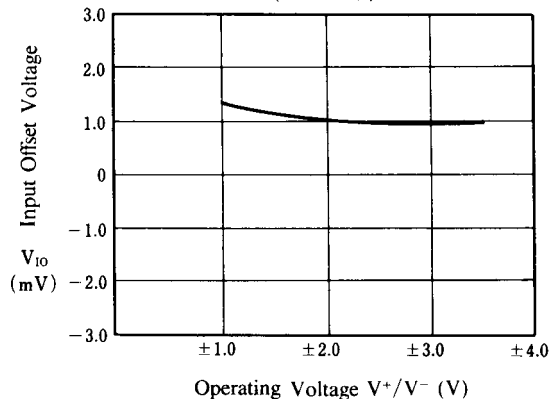

Maximum Output Voltage Swing vs. Frequency

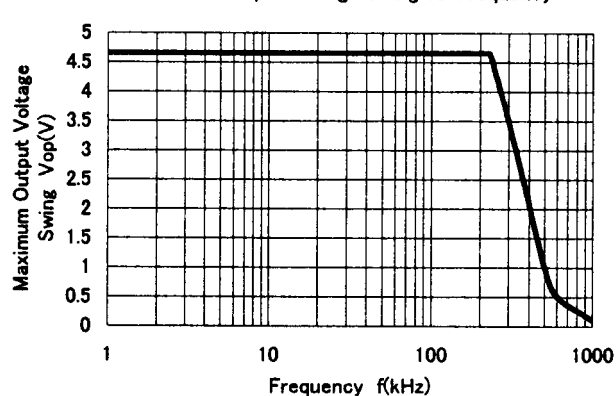

[CAUTION]

The specifications on this databook are only given for information, without any guarantee as regards either mistakes or omissions. The application circuits in this databook are described only to show representative usages of the product and not intended for the guarantee or permission of any right including the industrial rights.

Mouser Electronics

Authorized Distributor

Click to View Pricing, Inventory, Delivery & Lifecycle Information:

[Nisshinbo Micro Devices:](#)

[NJM2100D](#) [NJM2100L](#) [NJM2100M](#)