



DUAL J-FET INPUT OPERATIONAL AMPLIFIER

■ GENERAL DESCRIPTION

The NJM072B/082B & NJM072/082 are dual JFET input operational amplifiers. They feature low input bias and offset currents, high input impedance and fast slew rate. The low harmonic distortion and low noise make them ideally suit for amplifiers with high fidelity and audio amplifier applications.

The NJM072/082 may cause oscillation in some application like voltage follower.

■ FEATURES

- Operating Voltage (±4V ~ ±18V)
- J-FET Input
- High Input Resistance (10¹²Ω typ.)
- Low Input Resistance (30pA typ.)
- High Slew Rate (13V/μs, 20V/μs typ.)
- Wide Unity Gain Bandwidth (3MHz, 5MHz typ.)
- Package Outline DIP8, DMP8, SSOP8, SIP8
- Bipolar Technology

■ PACKAGE OUTLINE

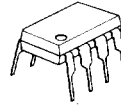

NJM072BD/082BD
NJM072D/082D



NJM072BM/082BM
NJM072M/082M

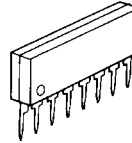

NJM072BL/082BL
NJM072L/082L

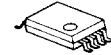

NJM072BV/082BV

■ PIN CONFIGURATION

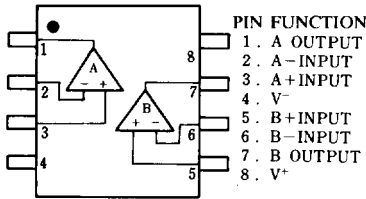

NJM072BD/082BD
NJM072D/082D
NJM072M/082M
NJM072BM/082BM
NJM072BV/082BV

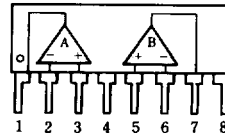

NJM072L/082L
NJM072BL/082BL

4

■ EQUIVALENT CIRCUIT

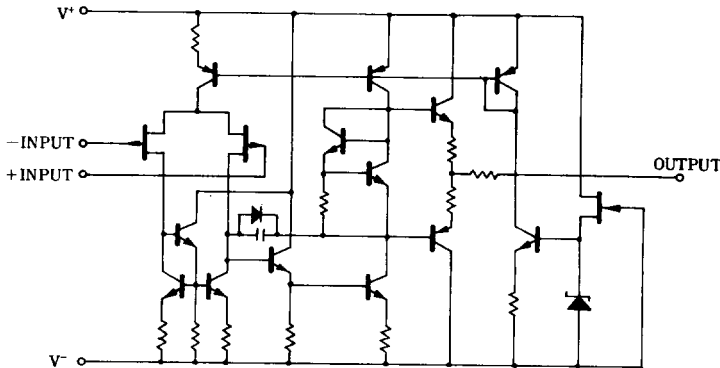



■ ABSOLUTE MAXIMUM RATINGS

(Ta=25°C)

PARAMETER	SYMBOL	RATINGS	UNIT
Supply Voltage	V ⁺ /V ⁻	±18	V
Input Voltage	V _I	±15	V
Differential Input Voltage	V _{ID}	±30	V
Power Dissipation	P _D	(DIP8) 500	mW
		(DMP8) 300	mW
		(SSOP8) 300	mW
		(SIP8) 800	mW
Operating Temperature Range	T _{opr}	-20 ~ +75	°C
Storage Temperature Range	T _{stg}	-40 ~ +125	°C

■ ELECTRICAL CHARACTERISTICS (Ta = +25°C, V⁺/V⁻ = ±15V)

() Applies to NJM082B, NJM082

PARAMETER	SYMBOL	TEST CONDITION	MIN.	TYP.	MAX.	UNIT
Input Offset Voltage	V _{IO}	R _S = 50Ω	—	3(5)	10(15)	mV
Input Offset Current	I _{IO}		—	5	50(200)	pA
Input Bias Current	I _B		—	30	200(400)	pA
Input Common Mode Voltage Range	V _{ICM}		±10	—	—	V
Maximum Peak-to-peak Output Voltage Swing	V _{OPP}	R _L = 10kΩ	24	27	—	V _{P-P}
Large-Signal Voltage Gain	A _V	R _L ≥ 2kΩ, V _O = ±10V	88	106	—	dB
Unity Gain Bandwidth	f _T	072B/082B	—	3	—	MHz
		072/082	—	5	—	MHz
Input Resistance	R _{IN}		—	10 ¹²	—	Ω
Common Mode Rejection Ratio	CMR	R _S ≤ 10kΩ	70	76	—	dB
Supply Voltage Rejection Ratio	SVR	R _S ≤ 10kΩ	70	76	—	dB
Operating Current	I _{CC}		—	3	5(5.6)	mA
Slew Rate	SR	072B/082B	—	13	—	V/μs
		072/082	—	20	—	V/μs
Equivalent Input Noise Voltage	V _{NI}	R _S = 100Ω, B.W. = 10~10kHz	—	4	—	μVrms

■ NOTICE WHEN APPLICATION

Recommendable product

072/082 are the products in which the AC feature have been made much higher comparing to the products of 072B/082B which are compatible with 072/082 type of other company's products. Therefore, 072/082 are unstable in oscillation when the voltage follower application, and it is recommendable to use the standard type 072B/082B when newly designed. Beside these products, we have NJM2082 which is higher up in AC feature, yet stability in oscillation, and then the driving capacity to the load at the output stage is made much higher in operation.



■ TYPICAL CHARACTERISTICS

NJM072B/082B
Voltage Gain, Phase Shift vs. Frequency
($V^+/V^- = \pm 15V$, $Z_L = 2k\Omega // 100pF$, $T_a = 25^\circ C$)

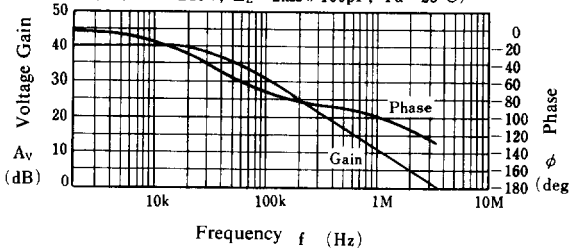

NJM072/082
Voltage Gain, Phase Shift vs. Frequency
($V^+/V^- = \pm 15V$, $Z_L = 2k\Omega // 100pF$, $T_a = 25^\circ C$)

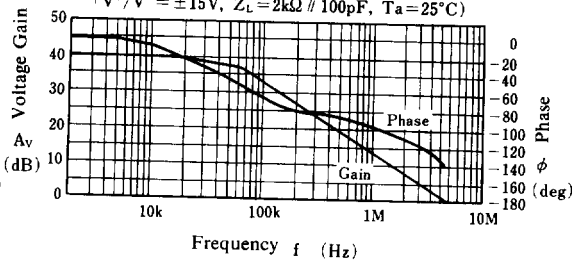

NJM072B/082B
Maximum Output Voltage Swing
vs. Frequency

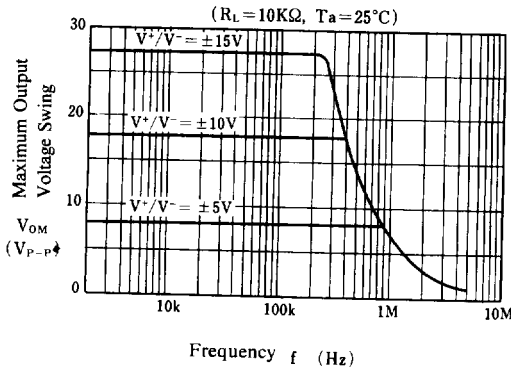

NJM072/082
Maximum Output Voltage Swing
vs. Frequency

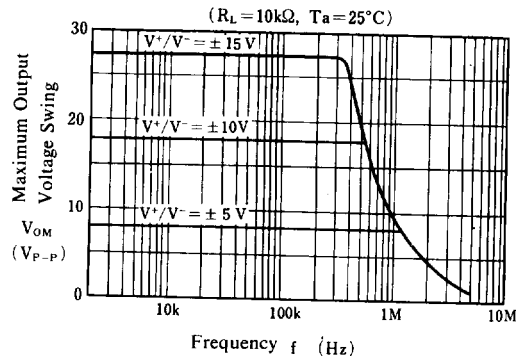

Maximum Output Voltage Swing
vs. Load Resistance

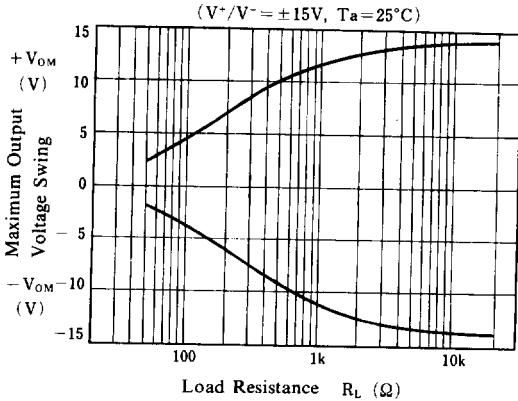

Equivalent Input
Voltage Noise vs. Frequency

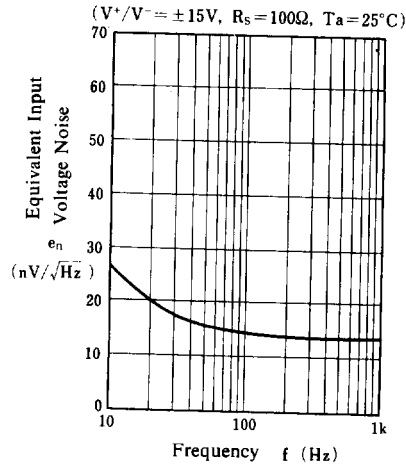

4



■ TYPICAL CHARACTERISTICS

Operating Current vs. Temperature

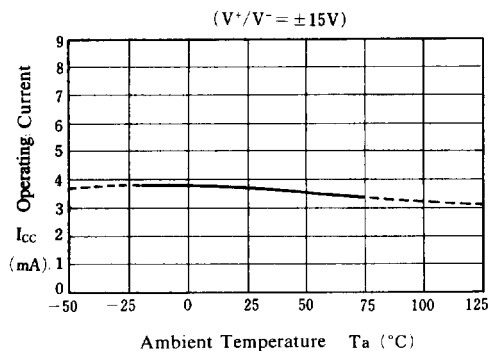

Maximum Output Voltage Swing vs. Temperature

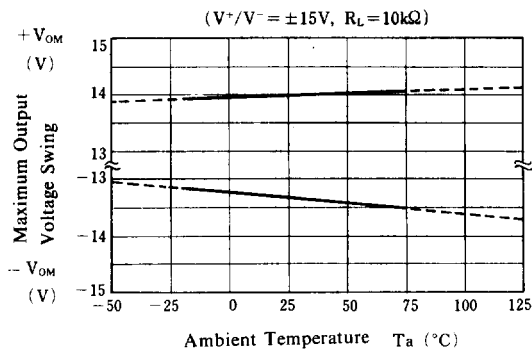

Input Offset Voltage vs. Temperature

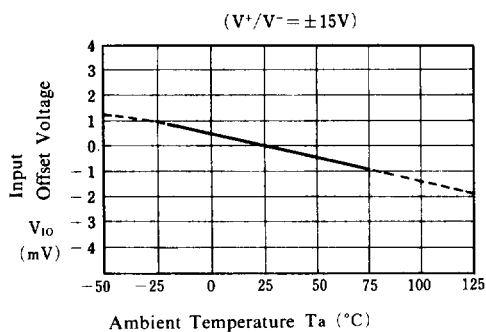

Input Bias Current vs. Temperature

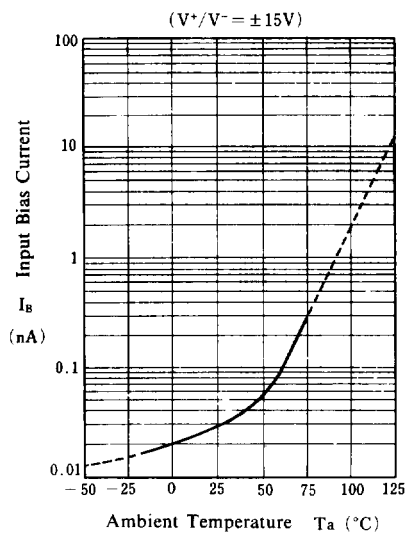

Maximum Output Voltage Swing vs. Operating Voltage

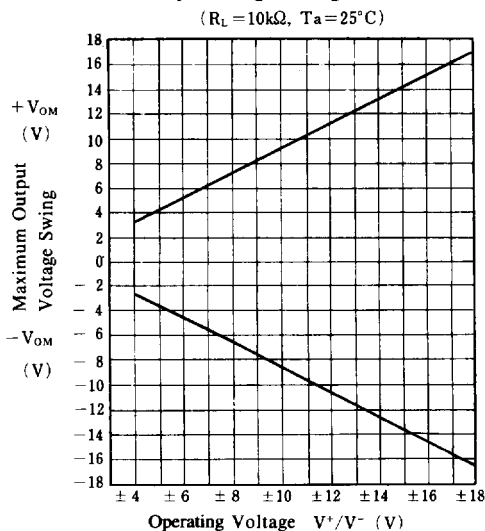

Operating Current vs. Operating Voltage

