

# LM4882 Boomer® Audio Power Amplifier Series

## 250mW Audio Power Amplifier with Shutdown Mode

### General Description

The LM4882 is a single-ended audio power amplifier capable of delivering 250mW of continuous average power into an 8Ω load with 1% THD+N from a 5V power supply.

Boomer® audio power amplifiers were designed specifically to provide high quality output power with a minimal amount of external components using surface mount packaging. Since the LM4882 does not require bootstrap capacitors or snubber networks, it is optimally suited for low-power portable systems.

The LM4882 features an externally controlled, low power consumption shutdown mode which is virtually clickless and popless, as well as an internal thermal shutdown protection mechanism.

The unity-gain stable LM4882 can be configured by external gain-setting resistors.

### Key Specifications

- THD+N at 1kHz at 250mW continuous average output power into 8Ω 1.0% (max)
- Output Power at 1% THD+N at 1kHz into 4Ω 380mW (typ)
- THD+N at 1kHz at 85mW continuous average output power into 32Ω 0.1% (typ)
- Shutdown Current 0.7μA (typ)

### Features

- MSOP surface mount packaging
- "Click and Pop" Suppression Circuitry
- Supply voltages from 2.4V–5.5V
- Operating Temperature –40°C to 85°C
- Unity-gain stable
- External gain configuration capability
- No bootstrap capacitors, or snubber circuits are necessary

### Applications

- Personal Computers
- Cellular Phones
- General Purpose Audio

### Typical Application

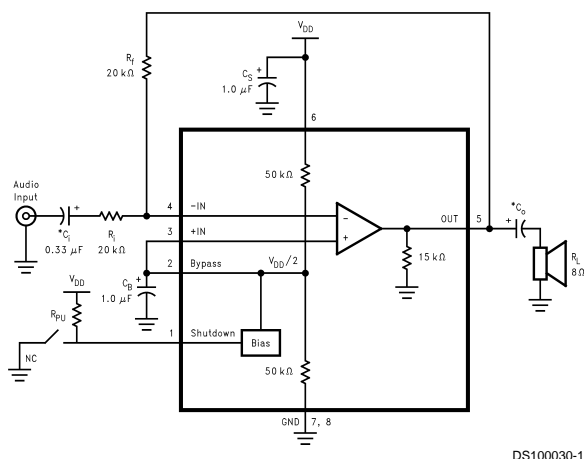

\*Refer to the **Application Information** Section for information concerning proper selection of the input and output coupling capacitors.

**FIGURE 1. Typical Audio Amplifier Application Circuit**

### Connection Diagram

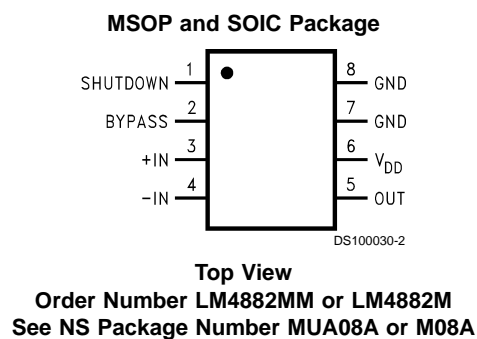

**Absolute Maximum Ratings** (Note 1)

If Military/Aerospace specified devices are required, please contact the National Semiconductor Sales Office/Distributors for availability and specifications.

Supply Voltage	6.0 V
Storage Temperature	-65°C to +150°C
Input Voltage	-0.3V to $V_{DD} + 0.3V$
Power Dissipation (Note 3)	Internally limited
ESD Susceptibility (Note 4)	2000V
Pin 5	1500V
Junction Temperature	150°C
Soldering Information	
Small Outline Package	
Vapor Phase (60 seconds)	215°C
Infrared (15 seconds)	220°C

See AN-450 "Surface Mounting and their Effects on Product Reliability" for other methods of soldering surface mount devices.

Thermal Resistance

$\theta_{JC}$ (MSOP)	56°C/W
$\theta_{JA}$ (MSOP)	210°C/W
$\theta_{JC}$ (SOP)	35°C/W
$\theta_{JA}$ (SOP)	170°C/W

**Operating Ratings**

Temperature Range

$T_{MIN} \leq T_A \leq T_{MAX}$	-40°C $\leq$ $T_A$ $\leq$ 85°C
Supply Voltage	2.4V $\leq$ $V_{DD}$ $\leq$ 5.5V

**Electrical Characteristics** (Notes 1, 2)

The following specifications apply for  $V_{DD} = 5V$  unless otherwise specified. Limits apply for  $T_A = 25^\circ C$ .

Symbol	Parameter	Conditions	LM4882		Units (Limits)	
			Typical (Note 5)	Limit (Note 6)		
$I_{DD}$	Quiescent Current	$V_{IN} = 0V, I_O = 0A$	2	4.0	mA (max)	
$I_{SD}$	Shutdown Current	$V_{pin1} = V_{DD}$	0.5	5	$\mu A$ (max)	
$V_{OS}$	Offset Voltage	$V_{IN} = 0V$	5	50	mV (max)	
$P_O$	Output Power	THD + N = 1% (max); f = 1 kHz;				
		$R_L = 4\Omega$	380	250	mW	
		$R_L = 8\Omega$	270		mW (min)	
		$R_L = 32\Omega$	95		mW	
		THD + N = 10%; f = 1 kHz				
		$R_L = 4\Omega$	480		mW	
$R_L = 8\Omega$	325		mW			
$R_L = 32\Omega$	125		mW			
THD + N	Total Harmonic Distortion + Noise	$R_L = 8\Omega, P_O = 250$ mWrms;	0.5		%	
		$R_L = 32\Omega, P_O = 85$ mWrms; f = 1 kHz	0.1		%	
PSRR	Power Supply Rejection Ratio	$V_{pin3} = 2.5V, V_{ripple} = 200$ mVrms, f = 120 Hz	50		dB	

**Electrical Characteristics** (Notes 1, 2)

The following specifications apply for  $V_{DD} = 3V$  unless otherwise specified. Limits apply for  $T_A = 25^\circ C$ .

Symbol	Parameter	Conditions	LM4882		Units (Limits)	
			Typical (Note 5)	Limit (Note 6)		
$I_{DD}$	Quiescent Current	$V_{IN} = 0V, I_O = 0A$	1.2		mA	
$I_{SD}$	Shutdown Current	$V_{pin1} = V_{DD}$	0.3		$\mu A$	
$V_{OS}$	Offset Voltage	$V_{IN} = 0V$	5		mV	
$P_O$	Output Power	THD + N = 1% (max); f = 1 kHz				
		$R_L = 8\Omega$	80		mW	
		$R_L = 32\Omega$	30		mW	
		THD + N = 10%; f = 1 kHz				
		$R_L = 8\Omega$	105		mW	
		$R_L = 32\Omega$	40		mW	

## Electrical Characteristics (Notes 1, 2) (Continued)

The following specifications apply for  $V_{DD} = 3V$  unless otherwise specified. Limits apply for  $T_A = 25^\circ C$ .

Symbol	Parameter	Conditions	LM4882		Units (Limits)
			Typical (Note 5)	Limit (Note 6)	
THD + N	Total Harmonic Distortion + Noise	$R_L = 8\Omega$ , $P_O = 70 \text{ mWrms}$ ;	0.25		%
		$R_L = 32\Omega$ , $P_O = 30 \text{ mWrms}$ ;	0.3		%
		$f = 1 \text{ kHz}$			
PSRR	Power Supply Rejection Ratio	$V_{pin3} = 2.5V$ , $V_{ripple} = 200 \text{ mVrms}$ , $f = 120 \text{ Hz}$	50		dB

**Note 1:** All voltages are measured with respect to the ground pin, unless otherwise specified.

**Note 2:** *Absolute Maximum Ratings* indicate limits beyond which damage to the device may occur. *Operating Ratings* indicate conditions for which the device is functional, but do not guarantee specific performance limits. *Electrical Characteristics* state DC and AC electrical specifications under particular test conditions which guarantee specific performance limits. This assumes that the device is within the Operating Ratings. Specifications are not guaranteed for parameters where no limit is given, however, the typical value is a good indication of device performance.

**Note 3:** The maximum power dissipation must be derated at elevated temperatures and is dictated by  $T_{JMAX}$ ,  $\theta_{JA}$ , and the ambient temperature  $T_A$ . The maximum allowable power dissipation is  $P_{DMAX} = (T_{JMAX} - T_A)/\theta_{JA}$ . For the LM4882,  $T_{JMAX} = 150^\circ C$ , and the typical junction-to-ambient thermal resistance, when board mounted, is  $210^\circ C/W$  for the MUA08A Package and  $170^\circ C/W$  for the M08A Package.

**Note 4:** Human body model, 100 pF discharged through a 1.5 k $\Omega$  resistor.

**Note 5:** Typical values are measured at  $25^\circ C$  and represent the parametric norm.

**Note 6:** Limits are guaranteed to National's AOQL (Average Outgoing Quality Level).

## External Components Description

(Refer to Figure 1)

Components	Functional Description
1. $R_i$	Inverting input resistance which sets the closed-loop gain in conjunction with $R_f$ . This resistor also forms a high pass filter with $C_i$ at $f_c = 1 / (2\pi R_i C_i)$ .
2. $C_i$	Input coupling capacitor which blocks the DC voltage at the amplifier's input terminals. Also creates a highpass filter with $R_i$ at $f_c = 1 / (2\pi R_i C_i)$ . Refer to the section, <b>Proper Selection of External Components</b> , for an explanation of how to determine the values of $C_i$ .
3. $R_f$	Feedback resistance which sets closed-loop gain in conjunction with $R_i$ .
4. $C_S$	Supply bypass capacitor which provides power supply filtering. Refer to the <b>Application Information</b> section for proper placement and selection of the supply bypass capacitor.
5. $C_B$	Bypass pin capacitor which provides half-supply filtering. Refer to the section, <b>Proper Selection of External Components</b> , for information concerning proper placement and selection of $C_B$ .
6. $C_O$	Output coupling capacitor which blocks the DC voltage at the amplifier's output. Forms a high pass filter with $R_L$ at $f_o = 1 / (2\pi R_L C_O)$ .

## Typical Performance Characteristics

THD+N vs Frequency

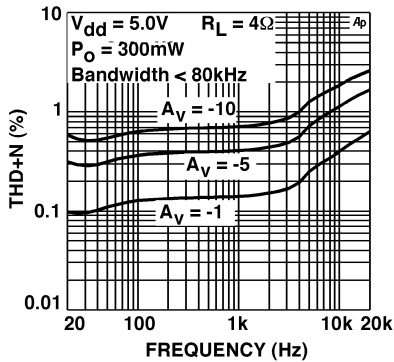

THD+N vs Frequency

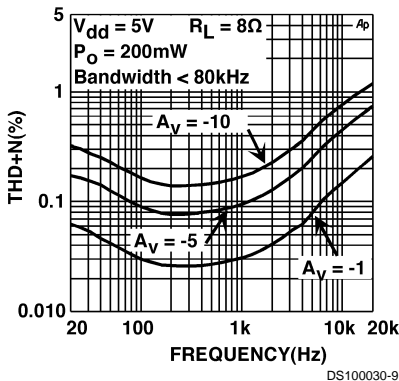

THD+N vs Frequency

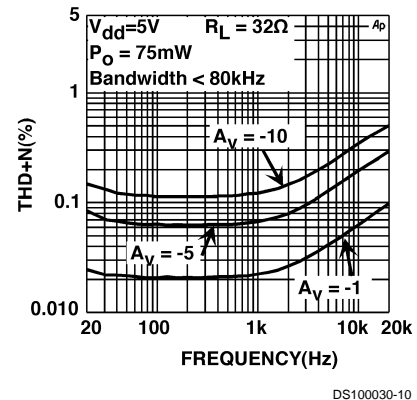

# Typical Performance Characteristics (Continued)

THD+N vs Frequency

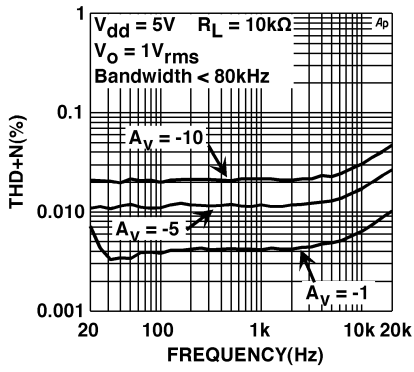

DS100030-11

THD+N vs Frequency

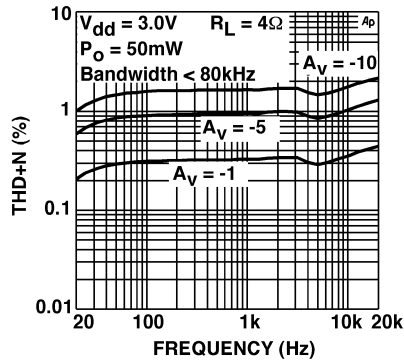

DS100030-23

THD+N vs Frequency

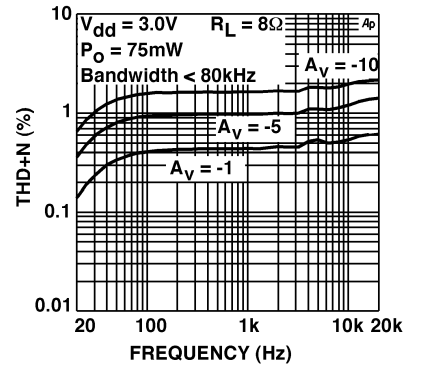

DS100030-22

THD+N vs Frequency

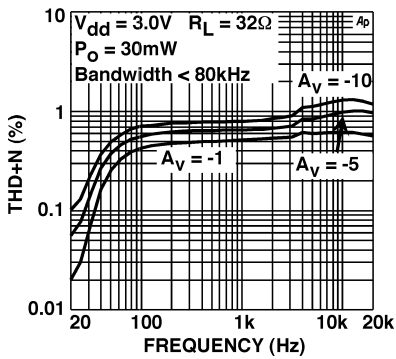

DS100030-24

THD+N vs Frequency

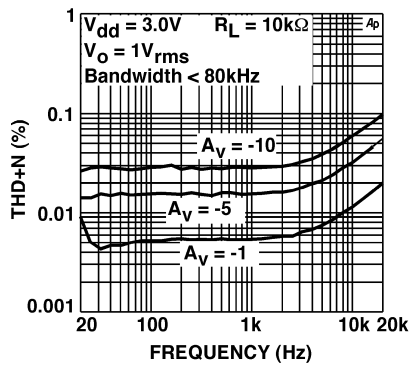

DS100030-25

THD+N vs Output Power

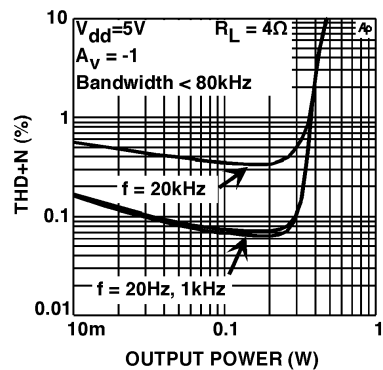

DS100030-29

THD+N vs Output Power

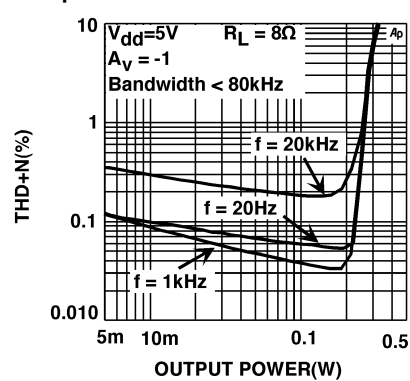

DS100030-4

THD+N vs Output Power

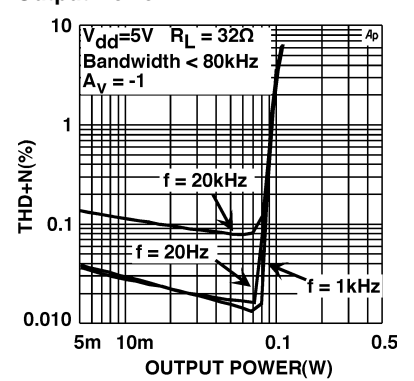

DS100030-8

# Typical Performance Characteristics (Continued)

THD+N vs Output Power

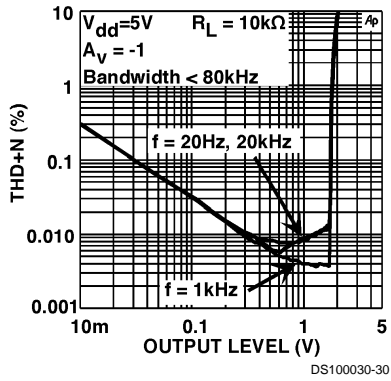

THD+N vs Output Power

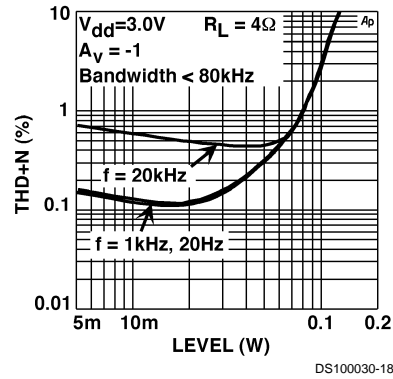

THD+N vs Output Power

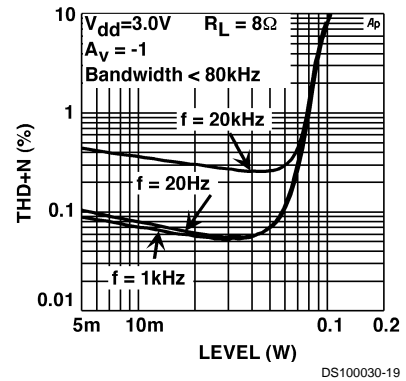

THD+N vs Output Power

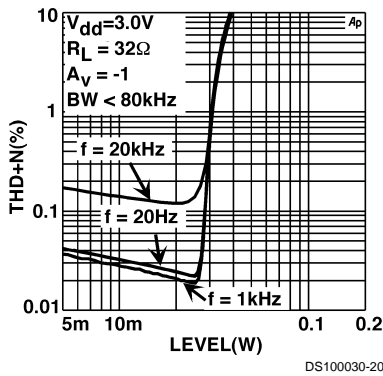

THD+N vs Output Power

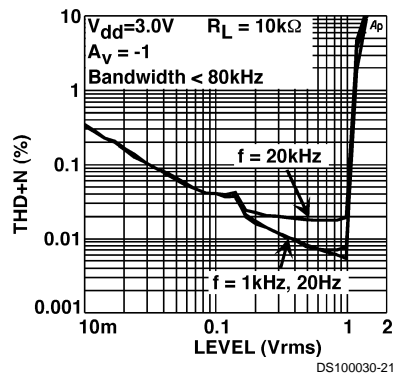

Output Power vs Supply Voltage

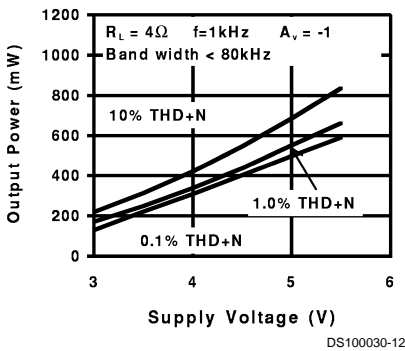

Output Power vs Supply Voltage

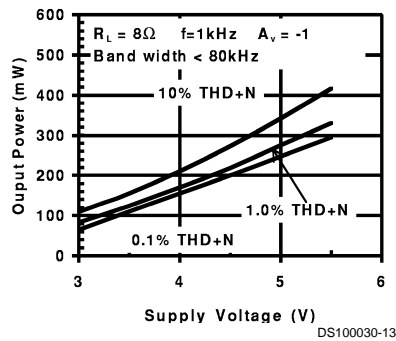

Output Power vs Supply Voltage

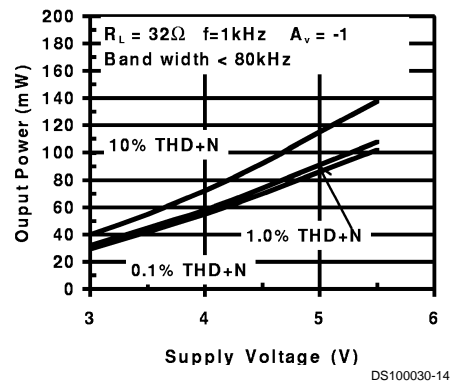

## Typical Performance Characteristics (Continued)

**Dropout Voltage vs Supply Voltage**

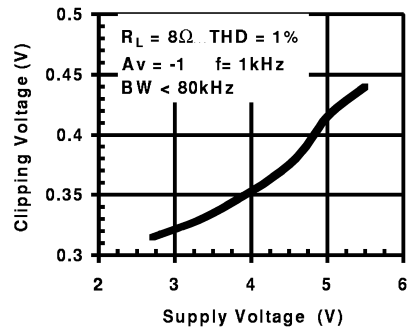

**Dropout Voltage vs Supply Voltage**

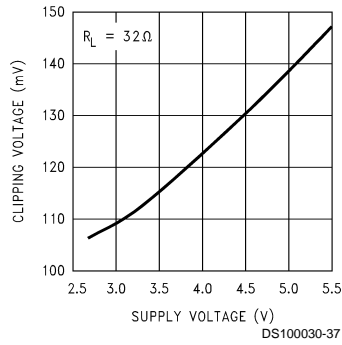

**Power Supply Rejection Ratio**

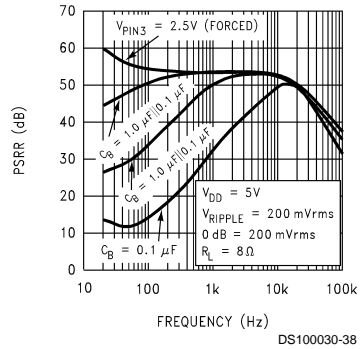

**Output Power vs Load Resistance**

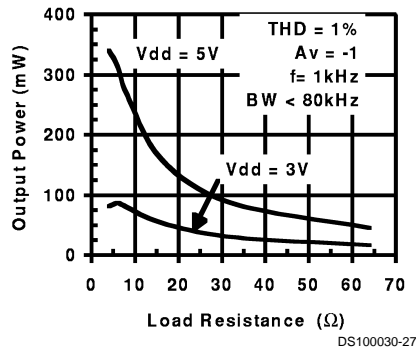

**Power Dissipation vs Output Power**

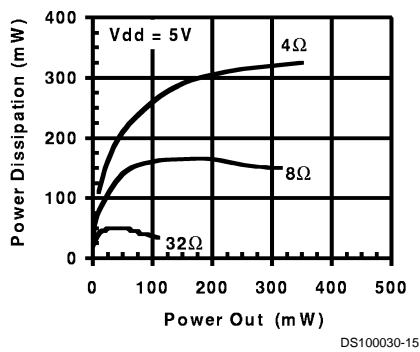

**Supply Current vs Supply Voltage**

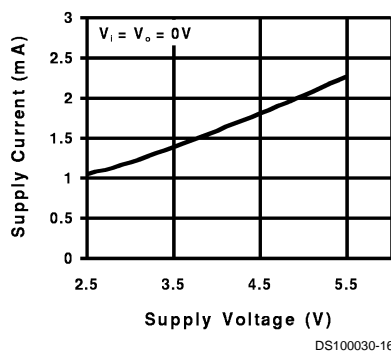

# Typical Performance Characteristics (Continued)

**Open Loop Frequency Response**

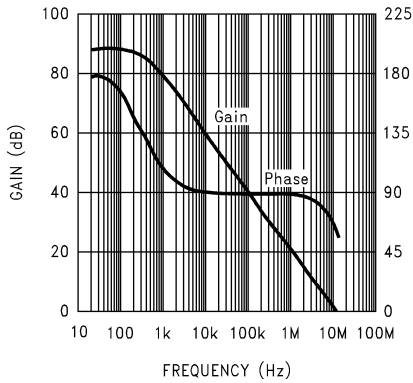

DS100030-36

**Output Attenuation in Shutdown Mode**

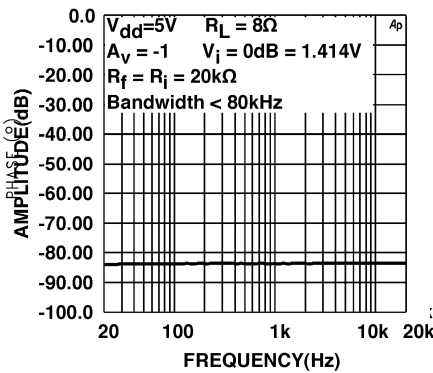

DS100030-6

**Noise Floor**

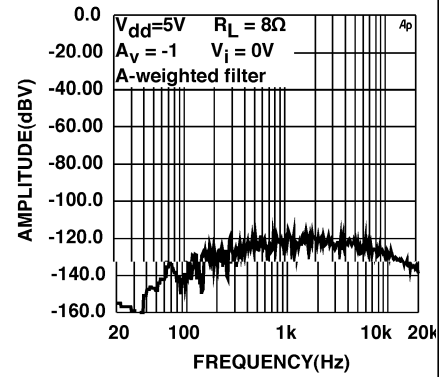

DS100030-7

**Frequency Response vs Output Capacitor Size**

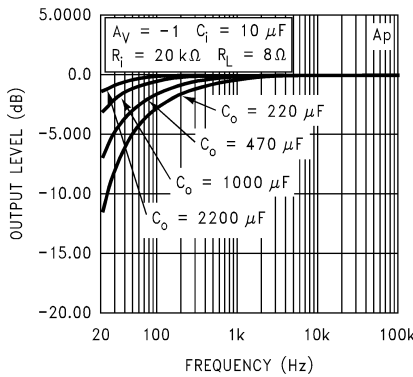

DS100030-31

**Frequency Response vs Output Capacitor Size**

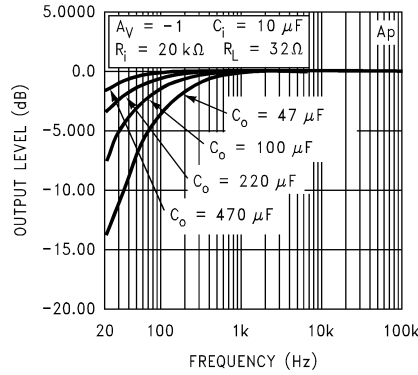

DS100030-32

**Frequency Response vs Input Capacitor Size**

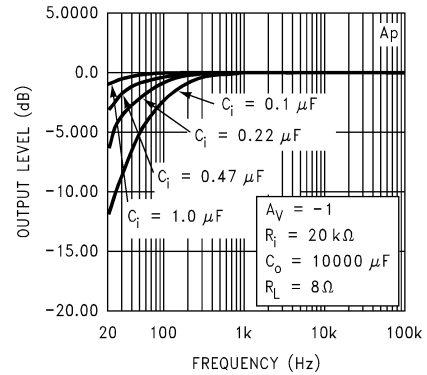

DS100030-33

**Typical Application Frequency Response**

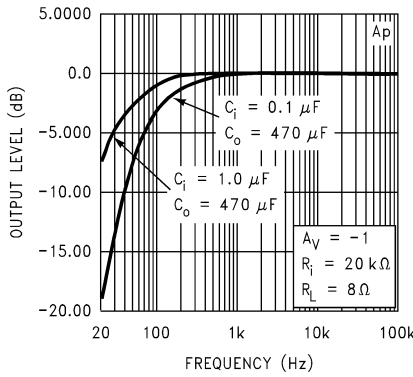

DS100030-34

**Typical Application Frequency Response**

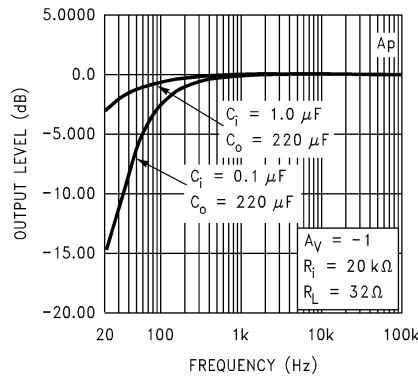

DS100030-35

**Power Derating Curve**

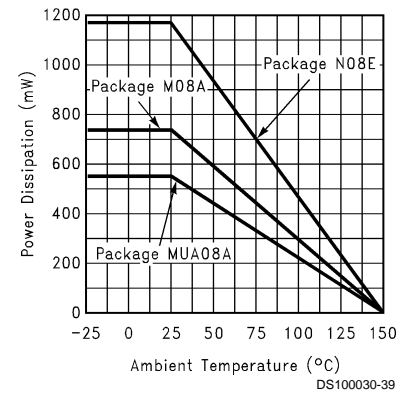

DS100030-39

## Application Information

### SHUTDOWN FUNCTION

In order to reduce power consumption while not in use, the LM4882 contains a shutdown pin to externally turn off the amplifier's bias circuitry. This shutdown feature turns the amplifier off when a logic high is placed on the shutdown pin. The trigger point between a logic low and logic high level is typically half supply. It is best to switch between ground and supply to provide maximum device performance. By switching the shutdown pin to the  $V_{DD}$ , the LM4882 supply current draw will be minimized in idle mode. While the device will be disabled with shutdown pin voltages less than  $V_{DD}$ , the idle current may be greater than the typical value of  $0.5 \mu\text{A}$ . In either case, the shutdown pin should be tied to a definite voltage because leaving the pin floating may result in an unwanted shutdown condition. In many applications, a microcontroller or microprocessor output is used to control the shutdown circuitry which provides a quick smooth transition into shutdown. Another solution is to use a single-pole, single-throw switch in conjunction with an external pull-up resistor. When the switch is closed, the shutdown pin is connected to ground and enables the amplifier. If the switch is open, then the external pull-up resistor will disable the LM4882. This scheme guarantees that the shutdown pin will not float which will prevent unwanted state changes.

### POWER DISSIPATION

Power dissipation is a major concern when using any power amplifier and must be thoroughly understood to ensure a successful design. Equation 1 states the maximum power dissipation point for a single-ended amplifier operating at a given supply voltage and driving a specified output load.

$$P_{DMAX} = (V_{DD})^2 / (2\pi^2 R_L) \quad (1)$$

Even with this internal power dissipation, the LM4882 does not require heat sinking over a large range of ambient temperature. From Equation 1, assuming a 5V power supply and an  $4\Omega$  load, the maximum power dissipation point is 316 mW. The maximum power dissipation point obtained must not be greater than the power dissipation that results from Equation 2:

$$P_{DMAX} = (T_{JMAX} - T_A) / \theta_{JA} \quad (2)$$

For the LM4882 surface mount package,  $\theta_{JA} = 210^\circ\text{C/W}$  and  $T_{JMAX} = 150^\circ\text{C}$ . Depending on the ambient temperature,  $T_A$ , of the system surroundings, Equation 2 can be used to find the maximum internal power dissipation supported by the IC packaging. If the result of Equation 1 is greater than that of Equation 2, then either the supply voltage must be decreased, the load impedance increased or  $T_A$  reduced. For the typical application of a 5V power supply, with an  $4\Omega$  load, the maximum ambient temperature possible without violating the maximum junction temperature is approximately  $83^\circ\text{C}$  provided that device operation is around the maximum power dissipation point. Power dissipation is a function of output power and thus, if typical operation is not around the maximum power dissipation point, the ambient temperature may be increased accordingly. Refer to the **Typical Performance Characteristics** curves for power dissipation information for lower output powers.

### POWER SUPPLY BYPASSING

As with any power amplifier, proper supply bypassing is critical for low noise performance and high power supply rejection. The capacitor location on both the bypass and power supply pins should be as close to the device as possible. As

displayed in the **Typical Performance Characteristics** section, the effect of a larger half supply bypass capacitor is improved low frequency PSRR due to increased half-supply stability. Typical applications employ a 5V regulator with  $10 \mu\text{F}$  and a  $0.1 \mu\text{F}$  bypass capacitors which aid in supply stability, but do not eliminate the need for bypassing the supply nodes of the LM4882. The selection of bypass capacitors, especially  $C_B$ , is thus dependent upon desired low frequency PSRR, click and pop performance as explained in the section, **Proper Selection of External Components** section, system cost, and size constraints.

### PROPER SELECTION OF EXTERNAL COMPONENTS

Selection of external components when using integrated power amplifiers is critical to optimize device and system performance. While the LM4882 is tolerant of external component combinations, consideration to component values must be used to maximize overall system quality.

The LM4882 is unity gain stable and this gives a designer maximum system flexibility. The LM4882 should be used in low gain configurations to minimize THD+N values, and maximize the signal to noise ratio. Low gain configurations require large input signals to obtain a given output power. Input signals equal to or greater than 1 Vrms are available from sources such as audio codecs. Please refer to the section, **Audio Power Amplifier Design**, for a more complete explanation of proper gain selection.

Besides gain, one of the major considerations is the closed loop bandwidth of the amplifier. To a large extent, the bandwidth is dictated by the choice of external components shown in *Figure 1*. Both the input coupling capacitor,  $C_i$ , and the output coupling capacitor,  $C_o$ , form first order high pass filters which limit low frequency response. These values should be chosen based on needed frequency response for a few distinct reasons.

### CLICK AND POP CIRCUITRY

The LM4882 contains circuitry to minimize turn-on and turn-off transients or "clicks and pops." In this case, turn-on refers to either power supply turn-on or the device coming out of shutdown mode. When the device is turning on, the amplifiers are internally muted. An internal current source ramps up the voltage of the bypass pin. Both the inputs and outputs track the voltage at the bypass pin. The device will remain muted until the bypass pin has reached its half supply voltage,  $1/2 V_{DD}$ . As soon as the bypass node is stable, the device will become fully operational, where the gain is set by the external resistors.

Although the bypass pin current source cannot be modified, the size of  $C_B$  can be changed to alter the device turn-on time and the level of "clicks and pops." By increasing the value of  $C_B$ , the level of turn-on pop can be reduced. However, the tradeoff for using a larger bypass capacitor is an increase in turn-on time for the device. There is a linear relationship between the size of  $C_B$  and the turn-on time. Here are some typical turn-on times for a given  $C_B$ :

$C_B$	$T_{ON}$
0.01 $\mu\text{F}$	20 ms
0.1 $\mu\text{F}$	200 ms
0.22 $\mu\text{F}$	420 ms
0.47 $\mu\text{F}$	900 ms

In order to eliminate "clicks and pops," all capacitors must be discharged before turn-on. Rapid on/off switching of the de-



## Application Information (Continued)

vice or the shutdown function may cause the “click and pop” circuitry to not operate fully, resulting in increased “click and pop” noise.

The value of  $C_i$  will also reflect turn-on pops. Clearly, a certain size for  $C_i$  is needed to couple in low frequencies without excessive attenuation. But in many cases, the speakers used in portable systems have little ability to reproduce signals below 100 Hz to 150 Hz. In this case, using a large input and output coupling capacitor may not increase system performance. In most cases, choosing a small value of  $C_i$  in the range of 0.1  $\mu\text{F}$  to 0.33  $\mu\text{F}$ , along with  $C_B$  equal to 1.0  $\mu\text{F}$  should produce a virtually clickless and popless turn-on. In cases where  $C_i$  is larger than 0.33  $\mu\text{F}$ , it may be advantageous to increase the value of  $C_B$ . Again, it should be understood that increasing the value of  $C_B$  will reduce the “clicks and pops” at the expense of a longer device turn-on time.

### AUDIO POWER AMPLIFIER DESIGN

#### Design a 250 mW/8 $\Omega$ Audio Amplifier

Given:

Power Output	250 mWrms
Load Impedance	8 $\Omega$
Input Level	1 Vrms (max)
Input Impedance	20 k $\Omega$
Bandwidth	100 Hz–20 kHz $\pm$ 0.50 dB

A designer must first determine the needed supply rail to obtain the specified output power. Calculating the required supply rail involves knowing two parameters,  $V_{\text{OPEAK}}$  and also the dropout voltage. The latter is typically 530mV and can be found from the graphs in the **Typical Performance Characteristics**.  $V_{\text{OPEAK}}$  can be determined from Equation 3.

$$V_{\text{opeak}} = \sqrt{(2R_L P_O)} \quad (3)$$

For 250 mW of output power into an 8 $\Omega$  load, the required  $V_{\text{OPEAK}}$  is 2 volts. A minimum supply rail of 4.55V results from adding  $V_{\text{OPEAK}}$  and  $V_{\text{OD}}$ . Since 5V is a standard supply voltage in most applications, it is chosen for the supply rail.

Extra supply voltage creates headroom that allows the LM4882 to reproduce peaks in excess of 300 mW without clipping the signal. At this time, the designer must make sure that the power supply choice along with the output impedance does not violate the conditions explained in the **Power Dissipation** section.

Once the power dissipation equations have been addressed, the required gain can be determined from Equation 4.

$$A_V \geq \sqrt{(P_O R_L)} / (V_{\text{IN}}) = V_{\text{orrms}} / V_{\text{inrms}} \quad (4)$$

$$A_V = R_f / R_i \quad (5)$$

From Equation 4, the minimum gain is:

$$A_V = 1.4$$

Since the desired input impedance was 20 k $\Omega$ , and with a gain of 1.4, a value of 28 k $\Omega$  is designated for  $R_f$ , assuming 5% tolerance resistors. This combination results in a nominal gain of 1.4. The final design step is to address the bandwidth requirements which must be stated as a pair of  $-3$  dB frequency points. Five times away from a  $-3$  dB point is 0.17 dB down from passband response assuming a single pole roll-off. As stated in the **External Components** section, both  $R_i$  in conjunction with  $C_i$ , and  $C_o$  with  $R_L$ , create first order high-pass filters. Thus to obtain the desired frequency low response of 100 Hz within  $\pm 0.5$  dB, both poles must be taken into consideration. The combination of two single order filters at the same frequency forms a second order response. This results in a signal which is down 0.34 dB at five times away from the single order filter  $-3$  dB point. Thus, a frequency of 20 Hz is used in the following equations to ensure that the response is better than 0.5 dB down at 100 Hz.

$$C_i \geq 1 / (2\pi * 20 \text{ k}\Omega * 20 \text{ Hz}) = 0.397 \mu\text{F}; \text{ use } 0.39 \mu\text{F}.$$

$$C_o \geq 1 / (2\pi * 8\Omega * 20 \text{ Hz}) = 995 \mu\text{F}; \text{ use } 1000 \mu\text{F}.$$

The high frequency pole is determined by the product of the desired high frequency pole,  $f_H$ , and the closed-loop gain,  $A_v$ . With a closed-loop gain of 1.4 and  $f_H = 100$  kHz, the resulting GBWP = 140 kHz which is much smaller than the LM4882 GBWP of 12.5Mhz. This figure displays that if a designer has a need to design an amplifier with a higher gain, the LM4882 can still be used without running into bandwidth limitations.

# Physical Dimensions inches (millimeters) unless otherwise noted

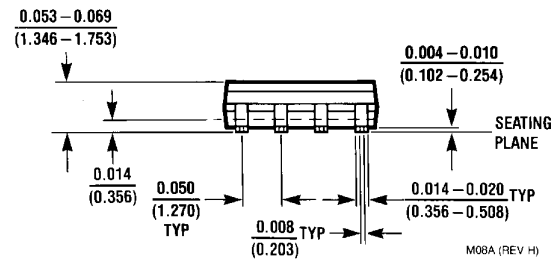
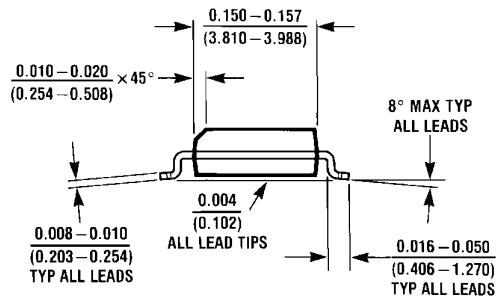
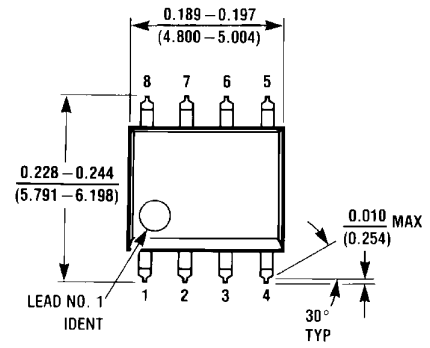

M08A (REV H)

Order Number LM4882  
NS Package Number M08A

**Physical Dimensions** inches (millimeters) unless otherwise noted (Continued)

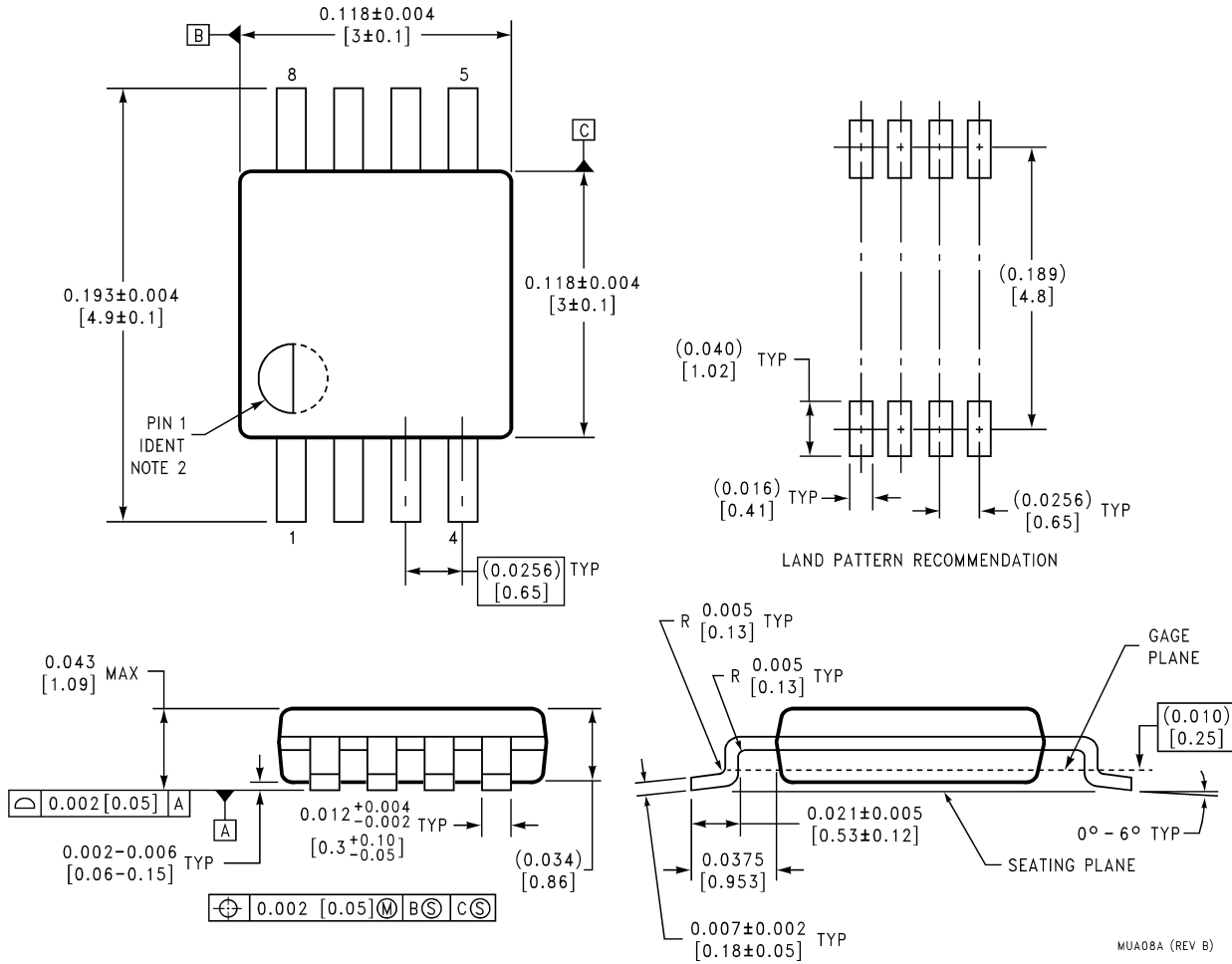

**Order Number LM4882**  
**NS Package Number MUA08A**

**LIFE SUPPORT POLICY**

NATIONAL'S PRODUCTS ARE NOT AUTHORIZED FOR USE AS CRITICAL COMPONENTS IN LIFE SUPPORT DEVICES OR SYSTEMS WITHOUT THE EXPRESS WRITTEN APPROVAL OF THE PRESIDENT AND GENERAL COUNSEL OF NATIONAL SEMICONDUCTOR CORPORATION. As used herein:

1. Life support devices or systems are devices or systems which, (a) are intended for surgical implant into the body, or (b) support or sustain life, and whose failure to perform when properly used in accordance with instructions for use provided in the labeling, can be reasonably expected to result in a significant injury to the user.
2. A critical component is any component of a life support device or system whose failure to perform can be reasonably expected to cause the failure of the life support device or system, or to affect its safety or effectiveness.

**National Semiconductor Corporation**  
 Americas  
 Tel: 1-800-272-9959  
 Fax: 1-800-737-7018  
 Email: support@nsc.com  
 www.national.com

**National Semiconductor Europe**  
 Fax: +49 (0) 180-530 85 86  
 Email: europe.support@nsc.com  
 Deutsch Tel: +49 (0) 69 9508 6208  
 English Tel: +44 (0) 870 24 0 2171  
 Français Tel: +33 (0) 1 41 91 8790

**National Semiconductor Asia Pacific Customer Response Group**  
 Tel: 65-2544466  
 Fax: 65-2504466  
 Email: ap.support@nsc.com

**National Semiconductor Japan Ltd.**  
 Tel: 81-3-5639-7560  
 Fax: 81-3-5639-7507

This datasheet has been download from:

[www.datasheetcatalog.com](http://www.datasheetcatalog.com)

Datasheets for electronics components.

# National Semiconductor was acquired by Texas Instruments.

[http://www.ti.com/corp/docs/investor\\_relations/pr\\_09\\_23\\_2011\\_national\\_semiconductor.html](http://www.ti.com/corp/docs/investor_relations/pr_09_23_2011_national_semiconductor.html)

This file is the datasheet for the following electronic components:

LM4882 - <http://www.ti.com/product/lm4882?HQS=TI-null-null-dscatalog-df-pf-null-ww>