

Dual ground sense operational amplifier

BA10358 / BA10358F / BA10358FV / BA10358N

The BA10358, BA10358F, BA10358FV, and BA10358N are monolithic ICs with two independent built-in operational amplifiers featuring high gain and frequency compensation.

These products offer a particularly wide range of operating voltages, from 3 to 32V (when using a single power supply). Current dissipation is low and remains constant regardless of the power supply voltage. Available packages include an 8-pin DIP (BA10358), an 8-pin SOP (BA10358F), an 8-pin SSOP-B (BA10358FV), and an 8-pin SIP (BA10358N).

●Features

- 1) Can be driven with a single power supply.
- 2) Extremely low current dissipation.
- 3) Level is compatible with any kind of logic circuit.
- 4) Operating voltage range is 3 to 32V for single power supply, ± 1.5 to ± 16 V for dual power supply.
- 5) High DC voltage gain.
- 6) Wide frequency response.
- 7) Pin assignments is the same as the general-purpose 4558 model.
- 8) Compatible with model 358 operation amplifiers of other manufacturers.

●Absolute maximum ratings

| Parameter | Symbol | Limits | | | | Unit |
|----------------------------|-----------|--------------------|--------------------|--------------------|--------------------|--------------------|
| | | BA10358 | BA10358F | BA10358FV | BA10358N | |
| Power supply voltage | V_{CC} | 32 (± 16) | 32 (± 16) | 32 (± 16) | 32 (± 16) | V |
| Power dissipation | P_d | 800* | 550* | 350* | 900* | mW |
| Differential input voltage | V_{ID} | $\pm V_{CC}$ | $\pm V_{CC}$ | $\pm V_{CC}$ | $\pm V_{CC}$ | V |
| Common-mode input voltage | V_I | $-0.3 \sim V_{CC}$ | $-0.3 \sim V_{CC}$ | $-0.3 \sim V_{CC}$ | $-0.3 \sim V_{CC}$ | V |
| Operating temperature | T_{opr} | $-40 \sim +85$ | $-40 \sim +85$ | $-40 \sim +85$ | $-40 \sim +85$ | $^{\circ}\text{C}$ |
| Storage temperature | T_{stg} | $-55 \sim +125$ | $-55 \sim +125$ | $-55 \sim +125$ | $-55 \sim +125$ | $^{\circ}\text{C}$ |

* Refer to the P_d characteristic diagram.

The values for the BA10358F are those when it is mounted on a glass epoxy board (50mm \times 50mm \times 1.6mm).

The values for the BA10358FV are those when it is mounted on a glass epoxy board (70mm \times 70mm \times 1.6mm).

●Block diagram

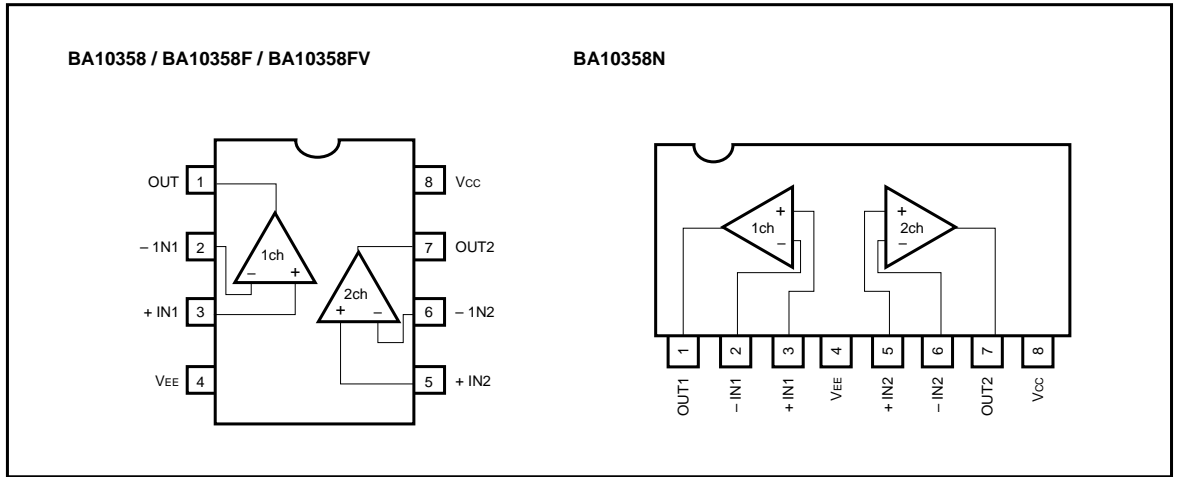

●Internal circuit configuration (diagram shows only one channel)

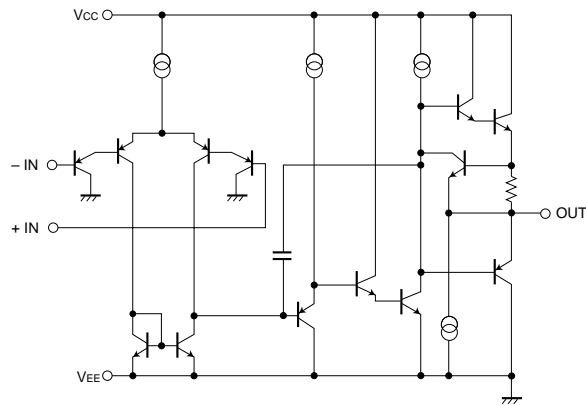

●Electrical characteristics (unless otherwise noted, $T_a = 25^\circ\text{C}$, $V_{CC} = +5\text{ V}$)

| Parameter | | Symbol | Min. | Typ. | Max. | Unit | Conditions |
|--------------------------------------|--------|--------------|------|------|----------------|--------|---|
| Input offset voltage | | V_{IO} | — | 2 | 7 | mV | $R_s = 50\Omega$ |
| Input offset current | | I_{IO} | — | 5 | 50 | nA | — |
| Input bias current | | I_B | — | 45 | 250 | nA | — |
| High-amplitude voltage gain | | A_v | 25 | 100 | — | V / mV | $R_L \geq 2k\Omega$, $V_{CC} = 15\text{V}$ |
| Common-mode input voltage | | V_{ICM} | 0 | — | $V_{CC} - 1.5$ | V | — |
| Output voltage | | V_O | 0 | — | $V_{CC} - 1.5$ | V | $R_L = 2k\Omega$ |
| Common-mode rejection ratio | | CMRR | 65 | 80 | — | dB | — |
| Power supply voltage rejection ratio | | PSRR | 65 | 100 | — | dB | $R_s = 50\Omega$ |
| Quiescent current | | I_Q | — | 0.7 | 1.2 | mA | $R_L = \infty$, on All Op - Amps |
| Channel separation | | CS | — | 120 | — | dB | $f = 1\text{ kHz}$ input conversion |
| Maximum output current | source | I_{source} | 10 | 20 | — | mA | $V_{IN}^+ = 1\text{V}$, $V_{IN}^- = 0\text{V}$, $V_O = 0\text{V}$ |
| | sink | I_{sink} | 10 | 20 | — | mA | $V_{IN}^- = 1\text{V}$, $V_{IN}^+ = 0\text{V}$, $V_O = V_{CC}$ |

●Electrical characteristic curves

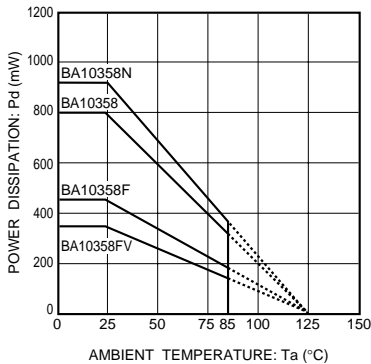

Fig. 1 Power dissipation vs. ambient temperature

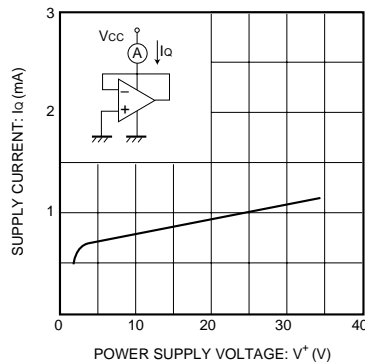

Fig. 2 Quiescent current vs. power supply voltage

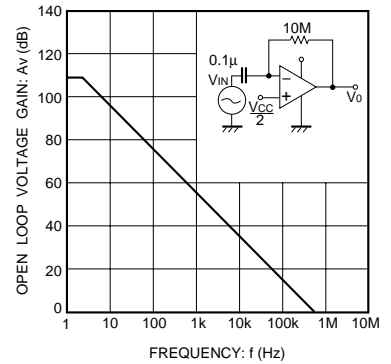

Fig. 3 Open loop voltage gain vs. frequency

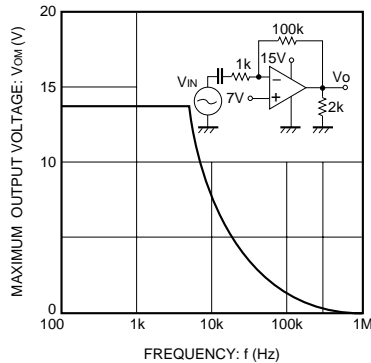

Fig. 4 Maximum output voltage vs. frequency

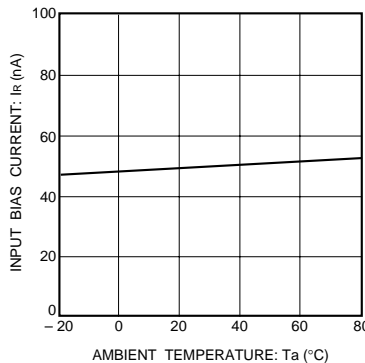

Fig. 5 Input bias current vs. ambient temperature

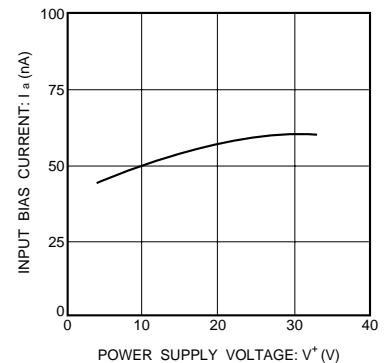

Fig. 6 Input bias current vs. power supply voltage

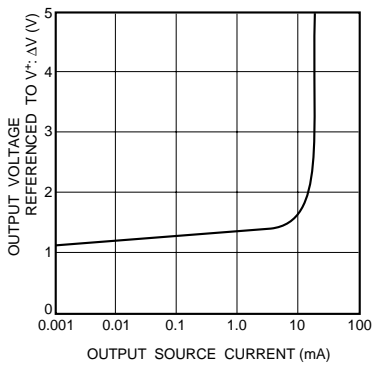

Fig. 7 Voltage difference during power supply output vs. output source current

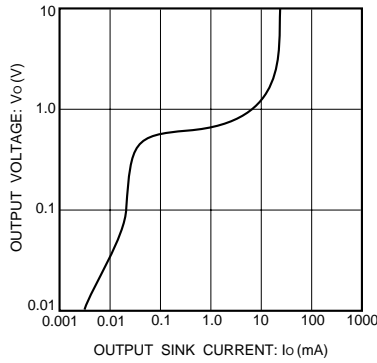

Fig. 8 Output voltage vs. output sink current

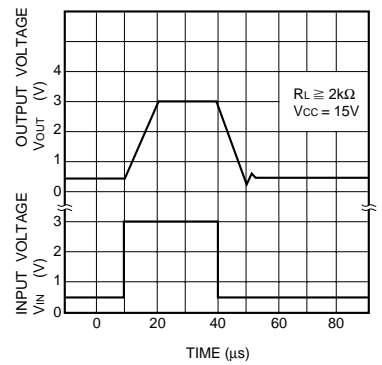

Fig. 9 Output response characteristics

● Operation notes

(1) Handling unused circuits

If there are any circuits which are not being used, we recommend making connections as shown in Figure 10, with the non-inverted input pin connected to the potential within the in-phase input voltage range (V_{ICM}).

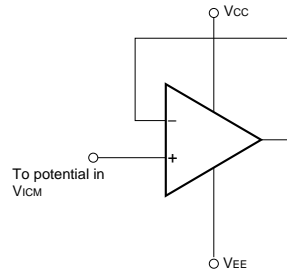

Fig. 10 Handling unused circuits

● External dimensions (Units: mm)

