

LM258, LM358, LM358A, LM2904, LM2904A, LM2904V, NCV2904, NCV2904V



ON Semiconductor®

<http://onsemi.com>

Single Supply Dual Operational Amplifiers

Utilizing the circuit designs perfected for Quad Operational Amplifiers, these dual operational amplifiers feature low power drain, a common mode input voltage range extending to ground/ V_{EE} , and single supply or split supply operation. The LM358 series is equivalent to one-half of an LM324.

These amplifiers have several distinct advantages over standard operational amplifier types in single supply applications. They can operate at supply voltages as low as 3.0 V or as high as 32 V, with quiescent currents about one-fifth of those associated with the MC1741 (on a per amplifier basis). The common mode input range includes the negative supply, thereby eliminating the necessity for external biasing components in many applications. The output voltage range also includes the negative power supply voltage.

Features

- Short Circuit Protected Outputs
- True Differential Input Stage
- Single Supply Operation: 3.0 V to 32 V
- Low Input Bias Currents
- Internally Compensated
- Common Mode Range Extends to Negative Supply
- Single and Split Supply Operation
- ESD Clamps on the Inputs Increase Ruggedness of the Device without Affecting Operation
- NCV Prefix for Automotive and Other Applications Requiring Site and Control Changes
- These Devices are Pb-Free, Halogen Free/BFR Free and are RoHS Compliant

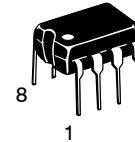

PDIP-8
N, AN, VN SUFFIX
CASE 626



SOIC-8
D, VD SUFFIX
CASE 751

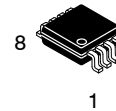

Micro8™
DMR2 SUFFIX
CASE 846A

PIN CONNECTIONS



ORDERING INFORMATION

See detailed ordering and shipping information in the package dimensions section on page 10 of this data sheet.

DEVICE MARKING INFORMATION

See general marking information in the device marking section on page 11 of this data sheet.

LM258, LM358, LM358A, LM2904, LM2904A, LM2904V, NCV2904, NCV2904V



Figure 1.



**Figure 2. Representative Schematic Diagram
(One-Half of Circuit Shown)**

LM258, LM358, LM358A, LM2904, LM2904A, LM2904V, NCV2904, NCV2904V

MAXIMUM RATINGS ($T_A = +25^\circ\text{C}$, unless otherwise noted.)

Rating	Symbol	Value	Unit
Power Supply Voltages Single Supply Split Supplies	V_{CC} V_{CC}, V_{EE}	32 ± 16	Vdc
Input Differential Voltage Range (Note 1)	V_{IDR}	± 32	Vdc
Input Common Mode Voltage Range (Note 2)	V_{ICR}	-0.3 to 32	Vdc
Output Short Circuit Duration	t_{SC}	Continuous	
Junction Temperature	T_J	150	$^\circ\text{C}$
Thermal Resistance, Junction-to-Air (Note 3)	$R_{\theta JA}$	238 212 161	$^\circ\text{C}/\text{W}$
		Case 846A Case 751 Case 626	
Storage Temperature Range	T_{stg}	-65 to +150	$^\circ\text{C}$
ESD Protection at any Pin Human Body Model Machine Model	V_{esd}	2000 200	V
Operating Ambient Temperature Range	T_A	-25 to +85 0 to +70 -40 to +105 -40 to +125 -40 to +150	$^\circ\text{C}$
		LM258 LM358, LM358A LM2904/LM2904A LM2904V, NCV2904 (Note 4) NCV2904V (Note 4)	

Stresses exceeding Maximum Ratings may damage the device. Maximum Ratings are stress ratings only. Functional operation above the Recommended Operating Conditions is not implied. Extended exposure to stresses above the Recommended Operating Conditions may affect device reliability.

1. Split Power Supplies.
2. For supply voltages less than 32 V the absolute maximum input voltage is equal to the supply voltage.
3. All $R_{\theta JA}$ measurements made on evaluation board with 1 oz. copper traces of minimum pad size. All device outputs were active.
4. *NCV2904 and NCV2904V are qualified for automotive use.*

LM258, LM358, LM358A, LM2904, LM2904A, LM2904V, NCV2904, NCV2904V

ELECTRICAL CHARACTERISTICS (V_{CC} = 5.0 V, V_{EE} = GND, T_A = 25°C, unless otherwise noted.)

Characteristic	Symbol	LM258			LM358			LM358A			Unit
		Min	Typ	Max	Min	Typ	Max	Min	Typ	Max	
Input Offset Voltage V _{CC} = 5.0 V to 30 V, V _{IC} = 0 V to V _{CC} - 1.7 V, V _O = 1.4 V, R _S = 0 Ω T _A = 25°C T _A = T _{high} (Note 5) T _A = T _{low} (Note 5)	V _{IO}	-	2.0	5.0	-	2.0	7.0	-	2.0	3.0	mV
Average Temperature Coefficient of Input Offset Voltage T _A = T _{high} to T _{low} (Note 5)	ΔV _{IO} /ΔT	-	7.0	-	-	7.0	-	-	7.0	-	μV/°C
Input Offset Current T _A = T _{high} to T _{low} (Note 5)	I _{IO}	-	3.0	30	-	5.0	50	-	5.0	30	nA
Input Bias Current T _A = T _{high} to T _{low} (Note 5)	I _{IB}	-	-45	-150	-	-45	-250	-	-45	-100	nA
Average Temperature Coefficient of Input Offset Current T _A = T _{high} to T _{low} (Note 5)	ΔI _{IO} /ΔT	-	10	-	-	10	-	-	10	-	μA/°C
Input Common Mode Voltage Range (Note 6), V _{CC} = 30 V V _{CC} = 30 V, T _A = T _{high} to T _{low}	V _{ICR}	0	-	28.3	0	-	28.3	0	-	28.5	V
Differential Input Voltage Range	V _{IDR}	-	-	V _{CC}	-	-	V _{CC}	-	-	V _{CC}	V
Large Signal Open Loop Voltage Gain R _L = 2.0 kΩ, V _{CC} = 15 V, For Large V _O Swing, T _A = T _{high} to T _{low} (Note 5)	A _{VOL}	50	100	-	25	100	-	25	100	-	V/mV
Channel Separation 1.0 kHz ≤ f ≤ 20 kHz, Input Referenced	CS	-	-120	-	-	-120	-	-	-120	-	dB
Common Mode Rejection R _S ≤ 10 kΩ	CMR	70	85	-	65	70	-	65	70	-	dB
Power Supply Rejection	PSR	65	100	-	65	100	-	65	100	-	dB
Output Voltage-High Limit T _A = T _{high} to T _{low} (Note 5) V _{CC} = 5.0 V, R _L = 2.0 kΩ, T _A = 25°C V _{CC} = 30 V, R _L = 2.0 kΩ V _{CC} = 30 V, R _L = 10 kΩ	V _{OH}	3.3	3.5	-	3.3	3.5	-	3.3	3.5	-	V
Output Voltage-Low Limit V _{CC} = 5.0 V, R _L = 10 kΩ, T _A = T _{high} to T _{low} (Note 5)	V _{OL}	-	5.0	20	-	5.0	20	-	5.0	20	mV
Output Source Current V _{ID} = +1.0 V, V _{CC} = 15 V T _A = T _{high} to T _{low} (LM358A Only)	I _{O+}	20	40	-	20	40	-	20	40	-	mA
Output Sink Current V _{ID} = -1.0 V, V _{CC} = 15 V T _A = T _{high} to T _{low} (LM358A Only) V _{ID} = -1.0 V, V _O = 200 mV	I _{O-}	10	20	-	10	20	-	10	20	-	mA
Output Short Circuit to Ground (Note 7)	I _{SC}	-	40	60	-	40	60	-	40	60	mA
Power Supply Current (Total Device) T _A = T _{high} to T _{low} (Note 5) V _{CC} = 30 V, V _O = 0 V, R _L = ∞ V _{CC} = 5 V, V _O = 0 V, R _L = ∞	I _{CC}	-	1.5	3.0	-	1.5	3.0	-	1.5	2.0	mA

5. LM258: T_{low} = -25°C, T_{high} = +85°C
 LM2904/LM2904A: T_{low} = -40°C, T_{high} = +105°C
 LM358, LM358A: T_{low} = 0°C, T_{high} = +70°C
 LM2904V & NCV2904: T_{low} = -40°C, T_{high} = +125°C
 NCV2904 and NCV2904V are qualified for automotive use. NCV2904V: T_{low} = -40°C, T_{high} = +150°C

6. The input common mode voltage or either input signal voltage should not be allowed to go negative by more than 0.3 V. The upper end of the common mode voltage range is V_{CC} - 1.7 V.
 7. Short circuits from the output to V_{CC} can cause excessive heating and eventual destruction. Destructive dissipation can result from simultaneous shorts on all amplifiers.

LM258, LM358, LM358A, LM2904, LM2904A, LM2904V, NCV2904, NCV2904V

ELECTRICAL CHARACTERISTICS ($V_{CC} = 5.0\text{ V}$, $V_{EE} = \text{Gnd}$, $T_A = 25^\circ\text{C}$, unless otherwise noted.)

Characteristic	Symbol	LM2904			LM2904A			LM2904V, NCV2904 NCV2904V			Unit
		Min	Typ	Max	Min	Typ	Max	Min	Typ	Max	
Input Offset Voltage $V_{CC} = 5.0\text{ V}$ to 30 V , $V_{IC} = 0\text{ V}$ to $V_{CC} - 1.7\text{ V}$, $V_O = 1.4\text{ V}$, $R_S = 0\ \Omega$ $T_A = 25^\circ\text{C}$ $T_A = T_{\text{high}}$ (Note 8) $T_A = T_{\text{low}}$ (Note 8)	V_{IO}	-	2.0	7.0	-	2.0	7.0	-	-	7.0	mV
Average Temperature Coefficient of Input Offset Voltage $T_A = T_{\text{high}}$ to T_{low} (Note 8)	$\Delta V_{IO}/\Delta T$	-	7.0	-	-	7.0	-	-	7.0	-	$\mu\text{V}/^\circ\text{C}$
Input Offset Current $T_A = T_{\text{high}}$ to T_{low} (Note 8)	I_{IO}	-	5.0	50	-	5.0	50	-	5.0	50	nA
Input Bias Current $T_A = T_{\text{high}}$ to T_{low} (Note 8)	I_{IB}	-	-45	-250	-	-45	-100	-	-45	-250	nA
Average Temperature Coefficient of Input Offset Current $T_A = T_{\text{high}}$ to T_{low} (Note 8)	$\Delta I_{IO}/\Delta T$	-	10	-	-	10	-	-	10	-	$\text{pA}/^\circ\text{C}$
Input Common Mode Voltage Range (Note 9), $V_{CC} = 30\text{ V}$ $V_{CC} = 30\text{ V}$, $T_A = T_{\text{high}}$ to T_{low}	V_{ICR}	0	-	28.3	0	-	28.3	0	-	28.3	V
Differential Input Voltage Range	V_{IDR}	-	-	V_{CC}	-	-	V_{CC}	-	-	V_{CC}	V
Large Signal Open Loop Voltage Gain $R_L = 2.0\text{ k}\Omega$, $V_{CC} = 15\text{ V}$, For Large V_O Swing, $T_A = T_{\text{high}}$ to T_{low} (Note 8)	A_{VOL}	25 15	100 -	- -	25 15	100 -	- -	25 15	100 -	- -	V/mV
Channel Separation $1.0\text{ kHz} \leq f \leq 20\text{ kHz}$, Input Referenced	CS	-	-120	-	-	-120	-	-	-120	-	dB
Common Mode Rejection $R_S \leq 10\text{ k}\Omega$	CMR	50	70	-	50	70	-	50	70	-	dB
Power Supply Rejection	PSR	50	100	-	50	100	-	50	100	-	dB
Output Voltage-High Limit $T_A = T_{\text{high}}$ to T_{low} (Note 8) $V_{CC} = 5.0\text{ V}$, $R_L = 2.0\text{ k}\Omega$, $T_A = 25^\circ\text{C}$ $V_{CC} = 30\text{ V}$, $R_L = 2.0\text{ k}\Omega$ $V_{CC} = 30\text{ V}$, $R_L = 10\text{ k}\Omega$	V_{OH}	3.3 26 27	3.5 - 28	- - -	3.3 26 27	3.5 - 28	- - -	3.3 26 27	3.5 - 28	- - -	V
Output Voltage-Low Limit $V_{CC} = 5.0\text{ V}$, $R_L = 10\text{ k}\Omega$, $T_A = T_{\text{high}}$ to T_{low} (Note 8)	V_{OL}	-	5.0	20	-	5.0	20	-	5.0	20	mV
Output Source Current $V_{ID} = +1.0\text{ V}$, $V_{CC} = 15\text{ V}$	I_{O+}	20	40	-	20	40	-	20	40	-	mA
Output Sink Current $V_{ID} = -1.0\text{ V}$, $V_{CC} = 15\text{ V}$ $V_{ID} = -1.0\text{ V}$, $V_O = 200\text{ mV}$	I_{O-}	10 -	20 -	- -	10 -	20 -	- -	10 -	20 -	- -	mA μA
Output Short Circuit to Ground (Note 10)	I_{SC}	-	40	60	-	40	60	-	40	60	mA
Power Supply Current (Total Device) $T_A = T_{\text{high}}$ to T_{low} (Note 8) $V_{CC} = 30\text{ V}$, $V_O = 0\text{ V}$, $R_L = \infty$ $V_{CC} = 5\text{ V}$, $V_O = 0\text{ V}$, $R_L = \infty$	I_{CC}	- -	1.5 0.7	3.0 1.2	- -	1.5 0.7	3.0 1.2	- -	1.5 0.7	3.0 1.2	mA

8. LM258: $T_{\text{low}} = -25^\circ\text{C}$, $T_{\text{high}} = +85^\circ\text{C}$ LM358, LM358A: $T_{\text{low}} = 0^\circ\text{C}$, $T_{\text{high}} = +70^\circ\text{C}$
 LM2904/LM2904A: $T_{\text{low}} = -40^\circ\text{C}$, $T_{\text{high}} = +105^\circ\text{C}$ LM2904V & NCV2904: $T_{\text{low}} = -40^\circ\text{C}$, $T_{\text{high}} = +125^\circ\text{C}$
NCV2904 and NCV2904V are qualified for automotive use. NCV2904V: $T_{\text{low}} = -40^\circ\text{C}$, $T_{\text{high}} = +150^\circ\text{C}$
9. The input common mode voltage or either input signal voltage should not be allowed to go negative by more than 0.3 V. The upper end of the common mode voltage range is $V_{CC} - 1.7\text{ V}$.
10. Short circuits from the output to V_{CC} can cause excessive heating and eventual destruction. Destructive dissipation can result from simultaneous shorts on all amplifiers.

CIRCUIT DESCRIPTION

The LM358 series is made using two internally compensated, two-stage operational amplifiers. The first stage of each consists of differential input devices Q20 and Q18 with input buffer transistors Q21 and Q17 and the differential to single ended converter Q3 and Q4. The first stage performs not only the first stage gain function but also performs the level shifting and transconductance reduction functions. By reducing the transconductance, a smaller compensation capacitor (only 5.0 pF) can be employed, thus saving chip area. The transconductance reduction is accomplished by splitting the collectors of Q20 and Q18. Another feature of this input stage is that the input common mode range can include the negative supply or ground, in single supply operation, without saturating either the input devices or the differential to single-ended converter. The second stage consists of a standard current source load amplifier stage.

Each amplifier is biased from an internal-voltage regulator which has a low temperature coefficient thus giving each amplifier good temperature characteristics as well as excellent power supply rejection.

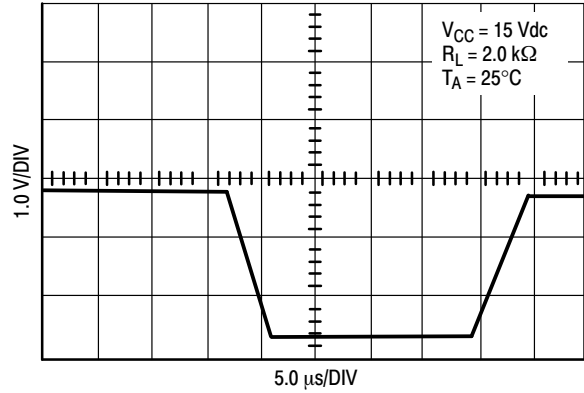

Figure 3. Large Signal Voltage Follower Response

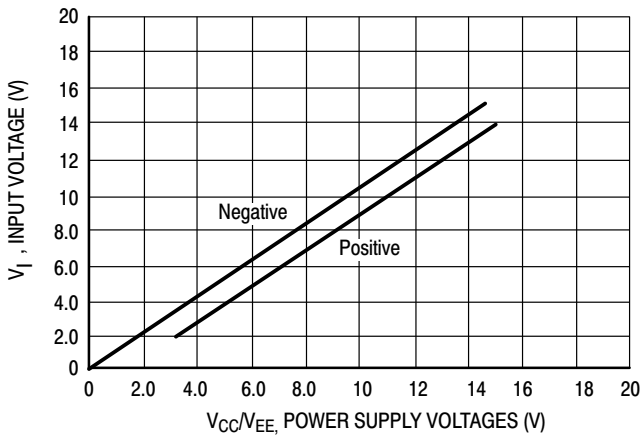

Figure 4. Input Voltage Range

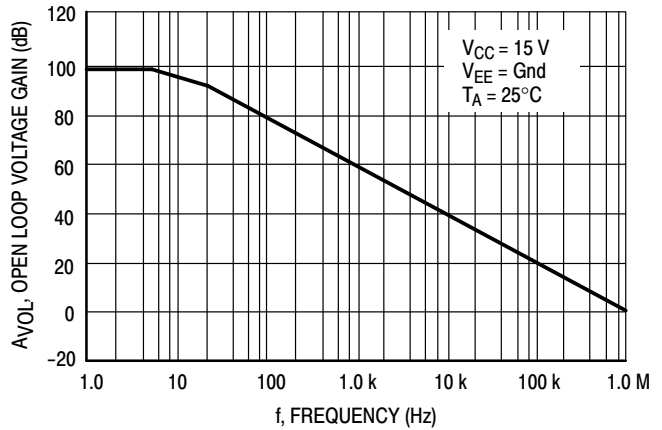

Figure 5. Large-Signal Open Loop Voltage Gain



Figure 6. Large-Signal Frequency Response



Figure 7. Small Signal Voltage Follower Pulse Response (Noninverting)

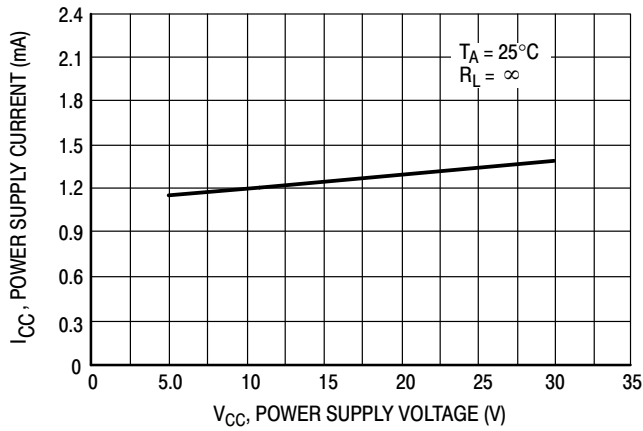

Figure 8. Power Supply Current versus Power Supply Voltage



Figure 9. Input Bias Current versus Supply Voltage



Figure 10. Voltage Reference



Figure 11. Wien Bridge Oscillator

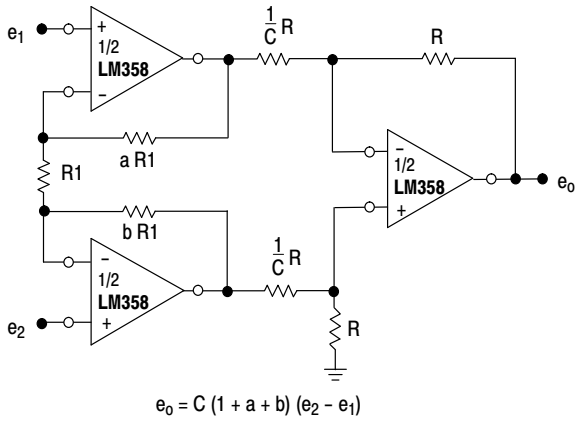

Figure 12. High Impedance Differential Amplifier



Figure 13. Comparator with Hysteresis



Figure 14. Bi-Quad Filter



Figure 15. Function Generator



Given: f_0 = center frequency
 $A(f_0)$ = gain at center frequency

Choose value f_0, C

Then: $R3 = \frac{Q}{\pi f_0 C}$

$R1 = \frac{R3}{2 A(f_0)}$

$R2 = \frac{R1 R3}{4Q^2 R1 - R3}$

For less than 10% error from operational amplifier. $\frac{Q_0 f_0}{BW} < 0.1$

Where f_0 and BW are expressed in Hz.

If source impedance varies, filter may be preceded with voltage follower buffer to stabilize filter parameters.

Figure 16. Multiple Feedback Bandpass Filter

LM258, LM358, LM358A, LM2904, LM2904A, LM2904V, NCV2904, NCV2904V

ORDERING INFORMATION

Device	Operating Temperature Range	Package	Shipping [†]
LM358ADR2G	0°C to +70°C	SOIC-8 (Pb-Free)	2500 / Tape & Reel
LM358DG			98 Units / Rail
LM358DR2G			2500 / Tape & Reel
LM358DMR2G		Micro8 (Pb-Free)	4000 / Tape & Reel
LM358NG		PDIP-8 (Pb-Free)	50 Units / Rail
LM258DG	-25°C to +85°C	SOIC-8 (Pb-Free)	98 Units / Rail
LM258DR2G			2500 / Tape & Reel
LM258DMR2G		Micro8 (Pb-Free)	4000 / Tape & Reel
LM258NG		PDIP-8 (Pb-Free)	50 Units / Rail
LM2904DG	-40°C to +105°C	SOIC-8 (Pb-Free)	98 Units / Rail
LM2904DR2G			2500 / Tape & Reel
LM2904DMR2G		Micro8 (Pb-Free)	2500 / Tape & Reel
LM2904NG		PDIP-8 (Pb-Free)	50 Units / Rail
LM2904ADMG		Micro8 (Pb-Free)	4000 / Tape & Reel
LM2904ADMR2G			4000 / Tape & Reel
LM2904ANG		PDIP-8 (Pb-Free)	50 Units / Rail
LM2904VDG	-40°C to +125°C	SOIC-8 (Pb-Free)	98 Units / Rail
LM2904VDR2G			2500 / Tape & Reel
LM2904VDMR2G		Micro8 (Pb-Free)	4000 / Tape & Reel
LM2904VNG		PDIP-8 (Pb-Free)	50 Units / Rail
NCV2904DR2G		SOIC-8 (Pb-Free)	2500 / Tape & Reel
NCV2904DMR2G		Micro8 (Pb-Free)	4000 / Tape & Reel
NCV2904VDR2G	-40°C to +150°C	SOIC-8 (Pb-Free)	2500 / Tape & Reel

[†]For information on tape and reel specifications, including part orientation and tape sizes, please refer to our Tape and Reel Packaging Specifications Brochure, BRD8011/D.

MARKING DIAGRAMS



- x = 2 or 3
- A = Assembly Location
- WL, L = Wafer Lot
- YY, Y = Year
- WW, W = Work Week
- G = Pb-Free Package
- = Pb-Free Package – (Note: Microdot may be in either location)

*This diagram also applies to NCV2904

PACKAGE DIMENSIONS

PDIP-8
 N, AN, VN SUFFIX
 CASE 626-05
 ISSUE M



NOTES:

1. DIMENSIONING AND TOLERANCING PER ASME Y14.5M, 1994.
2. CONTROLLING DIMENSION: INCHES.
3. DIMENSION E IS MEASURED WITH THE LEADS RESTRAINED PARALLEL AT WIDTH E2.
4. DIMENSION E1 DOES NOT INCLUDE MOLD FLASH.
5. ROUNDED CORNERS OPTIONAL.

DIM	INCHES			MILLIMETERS		
	MIN	NOM	MAX	MIN	NOM	MAX
A	----	----	0.210	----	----	5.33
A1	0.015	----	----	0.38	----	----
b	0.014	0.018	0.022	0.35	0.46	0.56
C	0.008	0.010	0.014	0.20	0.25	0.36
D	0.355	0.365	0.400	9.02	9.27	10.02
D1	0.005	----	----	0.13	----	----
E	0.300	0.310	0.325	7.62	7.87	8.26
E1	0.240	0.250	0.280	6.10	6.35	7.11
E2	0.300 BSC			7.62 BSC		
E3	----	----	0.430	----	----	10.92
e	0.100 BSC			2.54 BSC		
L	0.115	0.130	0.150	2.92	3.30	3.81

PACKAGE DIMENSIONS

SOIC-8 NB
CASE 751-07
ISSUE AK



NOTES:

1. DIMENSIONING AND TOLERANCING PER ANSI Y14.5M, 1982.
2. CONTROLLING DIMENSION: MILLIMETER.
3. DIMENSION A AND B DO NOT INCLUDE MOLD PROTRUSION.
4. MAXIMUM MOLD PROTRUSION 0.15 (0.006) PER SIDE.
5. DIMENSION D DOES NOT INCLUDE DAMBAR PROTRUSION. ALLOWABLE DAMBAR PROTRUSION SHALL BE 0.127 (0.005) TOTAL IN EXCESS OF THE D DIMENSION AT MAXIMUM MATERIAL CONDITION.
6. 751-01 THRU 751-06 ARE OBSOLETE. NEW STANDARD IS 751-07.

DIM	MILLIMETERS		INCHES	
	MIN	MAX	MIN	MAX
A	4.80	5.00	0.189	0.197
B	3.80	4.00	0.150	0.157
C	1.35	1.75	0.053	0.069
D	0.33	0.51	0.013	0.020
G	1.27 BSC		0.050 BSC	
H	0.10	0.25	0.004	0.010
J	0.19	0.25	0.007	0.010
K	0.40	1.27	0.016	0.050
M	0°	8°	0°	8°
N	0.25	0.50	0.010	0.020
S	5.80	6.20	0.228	0.244

SOLDERING FOOTPRINT*



SCALE 6:1 (mm/inches)

*For additional information on our Pb-Free strategy and soldering details, please download the ON Semiconductor Soldering and Mounting Techniques Reference Manual, SOLDERRM/D.

LM258, LM358, LM358A, LM2904, LM2904A, LM2904V, NCV2904, NCV2904V

PACKAGE DIMENSIONS

Micro8™
CASE 846A-02
ISSUE H



NOTES:

1. DIMENSIONING AND TOLERANCING PER ANSI Y14.5M, 1982.
2. CONTROLLING DIMENSION: MILLIMETER.
3. DIMENSION A DOES NOT INCLUDE MOLD FLASH, PROTRUSIONS OR GATE BURRS. MOLD FLASH, PROTRUSIONS OR GATE BURRS SHALL NOT EXCEED 0.15 (0.006) PER SIDE.
4. DIMENSION B DOES NOT INCLUDE INTERLEAD FLASH OR PROTRUSION. INTERLEAD FLASH OR PROTRUSION SHALL NOT EXCEED 0.25 (0.010) PER SIDE.
5. 846A-01 OBSOLETE, NEW STANDARD 846A-02.

DIM	MILLIMETERS			INCHES		
	MIN	NOM	MAX	MIN	NOM	MAX
A	--	--	1.10	--	--	0.043
A1	0.05	0.08	0.15	0.002	0.003	0.006
b	0.25	0.33	0.40	0.010	0.013	0.016
c	0.13	0.18	0.23	0.005	0.007	0.009
D	2.90	3.00	3.10	0.114	0.118	0.122
E	2.90	3.00	3.10	0.114	0.118	0.122
e	0.65 BSC			0.026 BSC		
L	0.40	0.55	0.70	0.016	0.021	0.028
HE	4.75	4.90	5.05	0.187	0.193	0.199

SOLDERING FOOTPRINT*



*For additional information on our Pb-Free strategy and soldering details, please download the ON Semiconductor Soldering and Mounting Techniques Reference Manual, SOLDERRM/D.

Micro8 is a trademark of International Rectifier.

ON Semiconductor and are registered trademarks of Semiconductor Components Industries, LLC (SCILLC). SCILLC reserves the right to make changes without further notice to any products herein. SCILLC makes no warranty, representation or guarantee regarding the suitability of its products for any particular purpose, nor does SCILLC assume any liability arising out of the application or use of any product or circuit, and specifically disclaims any and all liability, including without limitation special, consequential or incidental damages. "Typical" parameters which may be provided in SCILLC data sheets and/or specifications can and do vary in different applications and actual performance may vary over time. All operating parameters, including "Typicals" must be validated for each customer application by customer's technical experts. SCILLC does not convey any license under its patent rights nor the rights of others. SCILLC products are not designed, intended, or authorized for use as components in systems intended for surgical implant into the body, or other applications intended to support or sustain life, or for any other application in which the failure of the SCILLC product could create a situation where personal injury or death may occur. Should Buyer purchase or use SCILLC products for any such unintended or unauthorized application, Buyer shall indemnify and hold SCILLC and its officers, employees, subsidiaries, affiliates, and distributors harmless against all claims, costs, damages, and expenses, and reasonable attorney fees arising out of, directly or indirectly, any claim of personal injury or death associated with such unintended or unauthorized use, even if such claim alleges that SCILLC was negligent regarding the design or manufacture of the part. SCILLC is an Equal Opportunity/Affirmative Action Employer. This literature is subject to all applicable copyright laws and is not for resale in any manner.

PUBLICATION ORDERING INFORMATION

LITERATURE FULFILLMENT:
Literature Distribution Center for ON Semiconductor
P.O. Box 5163, Denver, Colorado 80217 USA
Phone: 303-675-2175 or 800-344-3860 Toll Free USA/Canada
Fax: 303-675-2176 or 800-344-3867 Toll Free USA/Canada
Email: orderlit@onsemi.com

N. American Technical Support: 800-282-9855 Toll Free USA/Canada
Europe, Middle East and Africa Technical Support:
Phone: 421 33 790 2910
Japan Customer Focus Center
Phone: 81-3-5817-1050

ON Semiconductor Website: www.onsemi.com
Order Literature: <http://www.onsemi.com/orderlit>
For additional information, please contact your local Sales Representative

Mouser Electronics

Authorized Distributor

Click to View Pricing, Inventory, Delivery & Lifecycle Information:

ON Semiconductor:

[NCV2904DMR2](#) [NCV2904DMR2G](#) [NCV2904DR2](#) [NCV2904DR2G](#) [LM258D](#) [LM258DG](#) [LM258DMR2](#)
[LM258DMR2G](#) [LM258DR2](#) [LM258DR2G](#) [LM258N](#) [LM258NG](#) [LM2904ADMG](#) [LM2904ADMR2](#) [LM2904ADMR2G](#)
[LM2904AN](#) [LM2904ANG](#) [LM2904D](#) [LM2904DG](#) [LM2904DMR2](#) [LM2904DMR2G](#) [LM2904DR2](#) [LM2904DR2G](#)
[LM2904N](#) [LM2904NG](#) [LM2904VD](#) [LM2904VDG](#) [LM2904VDMR2](#) [LM2904VDMR2G](#) [LM2904VDR2](#) [LM2904VDR2G](#)
[LM2904VN](#) [LM2904VNG](#) [LM358D](#) [LM358DG](#) [LM358DMR2](#) [LM358DMR2G](#) [LM358DR2](#) [LM358DR2G](#) [LM358N](#)
[LM358NG](#) [LM358ADR2G](#)