

Preset equalizer sound control (P.S.C) IC

BA3842F

The BA3842F is a preset graphic equalizer IC with dynamic bass boost which is designed for audio equipment.

●Applications

Mini-component stereos

Micro-component stereos

Radio cassette recorders with CD

●Features

- 1) Includes preset equalizer function with five equalizer positions and a flat mode setting.
- 2) Built-in dynamic bass boost with gain settings from 0 to 20dB in steps of 5dB.
- 3) Low distortion and low noise.
- 4) Built-in dynamic bass boost and interlocked ALC (Auto Level Control).

●Absolute maximum ratings (Ta = 25°C)

| Parameter | Symbol | Limits | Unit |
|-----------------------|-----------------|----------|------|
| Applied voltage | V _{CC} | 11.0 | V |
| Power dissipation | P _d | 550* | mW |
| Operating temperature | Topr | -40~+85 | °C |
| Storage temperature | Tstg | -55~+125 | °C |

* Reduced by 5.5mW for each increase in Ta of 1°C over 25°C.

●Recommended operating conditions

| Parameter | Symbol | Limits | Unit |
|----------------------|-----------------|----------|------|
| Power supply voltage | V _{CC} | 8.0~10.5 | V |



● Block diagram

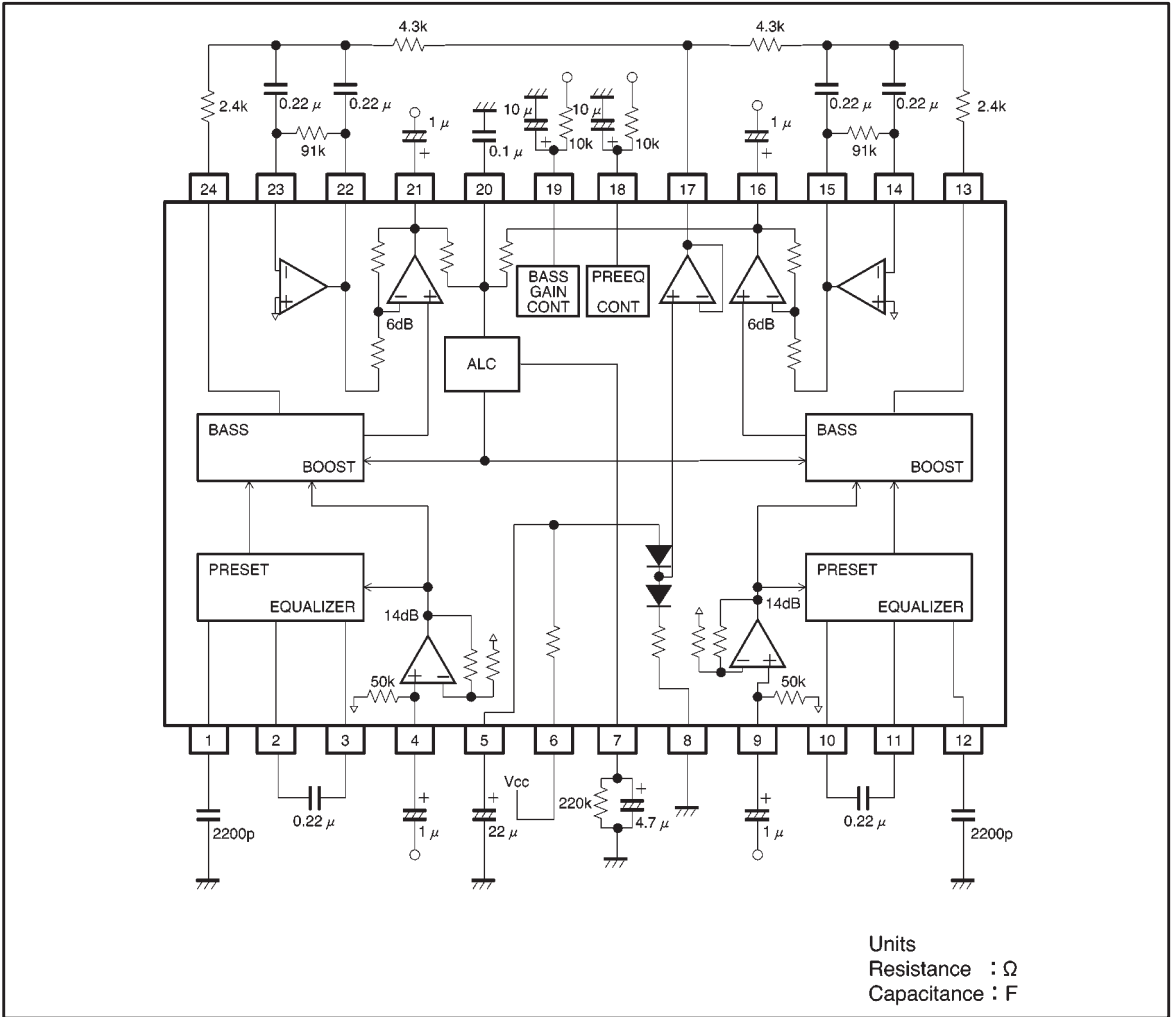

● Pin descriptions

| Pin No. | Pin name | Function |
|---------|----------|---|
| 1 | HPFL | Left channel preset equalizer high band filter |
| 2 | LPFL2 | Left channel preset equalizer low band filter |
| 3 | LPFL1 | Left channel preset equalizer low band filter |
| 4 | LIN | Left channel input |
| 5 | FILTER | Filter |
| 6 | Vcc | Power supply |
| 7 | ALCC | ALC time constant |
| 8 | GND | Ground |
| 9 | RIN | Right channel input |
| 10 | LRFR1 | Right channel preset equalizer low band filter |
| 11 | LRFR2 | Right channel preset equalizer low band filter |
| 12 | HPFR | Right channel preset equalizer high band filter |
| 13 | BAR1 | Right channel dynamic bass boost filter |
| 14 | BAR2 | Right channel dynamic bass boost filter |
| 15 | BAR3 | Right channel dynamic bass boost filter |
| 16 | ROUT | Right channel output |
| 17 | BIAS | Bias |
| 18 | SWGE | Preset equalizer mode switch |
| 19 | SWTB | Bass boost mode switch |
| 20 | CAP | ALC band setting filter |
| 21 | LOUT | Left channel output |
| 22 | BAL3 | Left channel dynamic bass boost filter |
| 23 | BAL2 | Left channel dynamic bass boost filter |
| 24 | BAL1 | Left channel dynamic bass boost filter |

● Input / output circuits

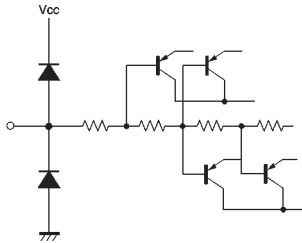
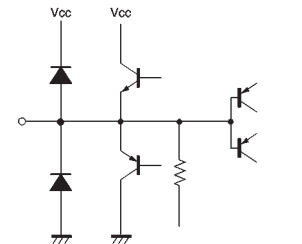
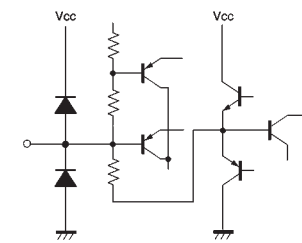
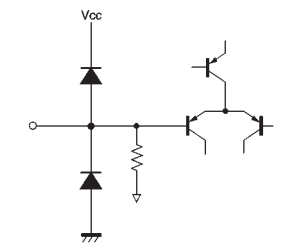
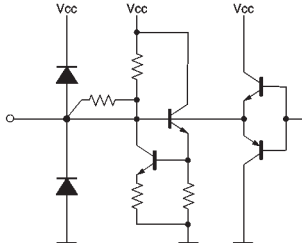
| Symbol | Pin No. | Equivalent circuit | Pin description |
|----------------|----------------|---|---|
| HPFL HPFR | 1 pin 12pin |  | Pin for setting the high cutoff frequency of the preset graphic equalizer. f_c is set by adding a capacitor between the pin and a bias or ground. |
| LPFL2 LPFR2 | 2 pin 11pin |  | Pin for setting the low cutoff frequency of the preset graphic equalizer. f_c is set by adding a capacitor between this pin and LPFL1/LPFR1. |
| LPFL1 LPFR1 | 3 pin 10pin |  | Pin for setting the low cutoff frequency of the preset graphic equalizer. f_c is set by adding a capacitor between this pin and LPFL2/LPFR2. |
| LIN RIN | 4 pin 9 pin |  | Signal input pin. Design the circuit for an input impedance of 50 kΩ (Typ.). |
| FILTER | 5 pin |  | Filter input pin. This will be approximately $1/2V_{CC} + 0.7$ V. Connect a 10 μF capacitor to this pin. Discharge and precharge circuits are built in, however, they will not be affected by the external capacitor. |

| Symbol | Pin No. | Equivalent circuit | Pin description |
|--------------|----------------|--------------------|--|
| ALCC | 7pin | | <p>Pin for setting the ALC time constant. Attack time and release time are set with an external resistor and capacitor.</p> |
| BAR1 BAL1 | 13pin 24pin | | <p>Pin for connecting the dynamic bass boost filter. ※ See "Precautions".</p> |
| BAR2 BAL2 | 14pin 23pin | | <p>Pin for connecting the dynamic bass boost filter. This pin has a high impedance, therefore, pattern wire should be short and direct. ※ See "Precautions".</p> |
| BAR3 BAL3 | 15pin 22pin | | <p>Pin for connecting the dynamic bass boost filter.</p> |
| ROUT LOUT | 16pin 21pin | | <p>Signal output pin.</p> |

| Symbol | Pin No. | Equivalent circuit | Pin description |
|--------|---------|--------------------|---|
| BIAS | 17pin | | <p>Bias output pin. When using a bias, the pattern wire should be close to the pin to reduce the impedance of the wire.</p> |
| SWGE | 18pin | | <p>Mode switch for preset graphic equalizer.</p> |
| SWTB | 19pin | | <p>Gain switch for dynamic bass boost.</p> |
| CAP | 20pin | | <p>Pin for setting the ALC band. Set the impedance of this pin at 10 kΩ (Typ.).</p> |
| Vcc | 6pin | — | <p>Supply voltage pin.</p> |
| GND | 8pin | — | <p>Ground pin.</p> |

- Electrical characteristics (unless otherwise noted, $T_a = 25^\circ\text{C}$, $V_{CC} = 10\text{V}$, $f = 1\text{kHz}$, $V_{IN} = 200\text{mV}_{\text{rms}}$, preset equalizer normal : $R_g = 620\Omega$, during dynamic bass boost : $R_L = 10\text{k}\Omega$)

| Parameter | Symbol | Min. | Typ. | Max. | Unit | Conditions |
|---------------------------|-----------------|------|------|------|----------------------------|--|
| Quiescent current | IQ | — | 7 | 17 | mA | Not designed to be radiation resistant. |
| Maximum output voltage | Vom | 2.4 | 2.8 | — | V _{rms} | THD=1% |
| Output voltage gain | Gv | 18 | 20 | 22 | dB | |
| Total harmonic distortion | THD | — | 0.01 | 0.05 | % | f=1kHz, BW : 400Hz~300kHz |
| Output noise voltage | Vno | — | 17 | 35 | μV_{rms} | $R_g=0$, DIN AUDIO* |
| Crosstalk | CT | — | -70 | -60 | dB | f=1kHz |
| Input impedance | R _{IN} | 35 | 50 | 65 | k Ω | |
| Ripple rejection ratio | RR | — | -41 | -35 | dB | fr=100Hz, V _{rIN} =100mV _{rms} |
| Channel balance | CB | -1.5 | 0 | 1.5 | dB | |

〈Dynamic bass boost〉

| | | | | | | |
|--------------------------|-----|-----|-----|-----|----|--|
| Boost level 1 | BB1 | 3 | 5 | 7 | dB | f=60Hz, TH1 V _{IN} =56mV _{rms} |
| Boost level 2 | BB2 | 8 | 10 | 12 | dB | f=60Hz, TH2 V _{IN} =30mV _{rms} |
| Boost level 3 | BB3 | 13 | 15 | 17 | dB | f=60Hz, TH3 V _{IN} =18mV _{rms} |
| Boost level 4 | BB4 | 18 | 20 | 22 | dB | f=60Hz, TH4 V _{IN} =10mV _{rms} |
| Switch control voltage 0 | TH0 | — | 0 | 0.3 | V | No bass boost |
| Switch control voltage 1 | TH1 | 1.0 | 1.3 | 1.6 | V | Boost level 1 position |
| Switch control voltage 2 | TH2 | 2.5 | 3.0 | 3.5 | V | Boost level 2 position |
| Switch control voltage 3 | TH3 | 4.5 | 5.0 | 5.5 | V | Boost level 3 position |
| Switch control voltage 4 | TH4 | 6.5 | 7.0 | 10 | V | Boost level 4 position |

〈Preset equalizer〉

| | | | | | | |
|--------------------------|-----------------|-----|-----|-----|---|---------|
| Switch control voltage F | TH _F | — | 0 | 0.3 | V | FLAT |
| Switch control voltage R | TH _R | 1.0 | 1.3 | 1.6 | V | ROCK |
| Switch control voltage P | TH _P | 2.5 | 3.0 | 3.5 | V | POP |
| Switch control voltage J | TH _J | 4.2 | 5.0 | 5.5 | V | JAZZ |
| Switch control voltage C | TH _C | 6.5 | 7.0 | 7.5 | V | CLASSIC |
| Switch control voltage B | TH _B | 8.5 | 9.0 | 10 | V | BGM |

* Measurement performed using Matsushita Communication Industrial VP-9690A DIN Audio filter (average value wave detection, effective value display).

©Not designed for radiation resistance.

Operating specifications

Input and output signal pins are in phase.

- Reference values for application circuit example (unless otherwise noted, $T_a = 25^\circ\text{C}$, $V_{CC} = 10\text{V}$, $V_{IN} = 200\text{mV}_{\text{rms}}$, preset equalizer normal : $R_g = 620\Omega$, during dynamic bass boost : $R_L = 10\text{k}\Omega$)

| Parameter | | Symbol | Typ. | Unit | Conditions | | |
|--------------------------|--------------|-------------------|------|----------------------------|--|-----------------|------------|
| 〈Preset equalizer〉 | | | | | | | |
| ROCK | Low range | G _{VRL} | 25 | dB | f=100Hz | TH _R | |
| ROCK | High range | G _{VRH} | 25 | dB | f=10kHz | TH _R | |
| POP | Low range | G _{VPL} | 19 | dB | f=100Hz | TH _P | |
| POP | Meduim range | G _{VPM} | 23 | dB | f=1kHz | TH _P | |
| POP | High range | G _{VPH} | 20 | dB | f=10kHz | TH _P | |
| JAZZ | Low range | G _{VJL} | 23 | dB | f=100Hz | TH _J | |
| JAZZ | High range | G _{VJH} | 23 | dB | f=10kHz | TH _J | |
| CLASSIC | Low range | G _{VCL} | 23 | dB | f=100Hz | TH _C | |
| CLASSIC | High range | G _{VCH} | 19 | dB | f=10kHz | TH _C | |
| BGM | Low range | G _{VBL} | 19 | dB | f=100Hz | TH _B | |
| BGM | High range | G _{VBH} | 18 | dB | f=10kHz | TH _B | |
| Output noise voltage | ROCK | V _{NOR} | 32 | μV_{rms} | R _g =0 | TH _R | DIO AUDIO* |
| | POP | V _{NOP} | 18 | μV_{rms} | R _g =0 | TH _R | DIO AUDIO* |
| | JAZZ | V _{NOJ} | 25 | μV_{rms} | R _g =0 | TH _J | DIO AUDIO* |
| | CLASSIC | V _{NOC} | 21 | μV_{rms} | R _g =0 | TH _C | DIO AUDIO* |
| | BGM | V _{NOB} | 17 | μV_{rms} | R _g =0 | TH _B | DIO AUDIO* |
| Output level when ALC on | | V _{OAGC} | 1.3 | V _{rms} | During dynamic bass boost, f=60Hz V _{IN} =130mV _{rms} | | |

* Measurement performed using Matsushita Communication Industrial VP-9690A DIN Audio filter (average value wave detection, effective value display).

Operating specifications

Input and output signal pins are in phase.

● Measurement circuit

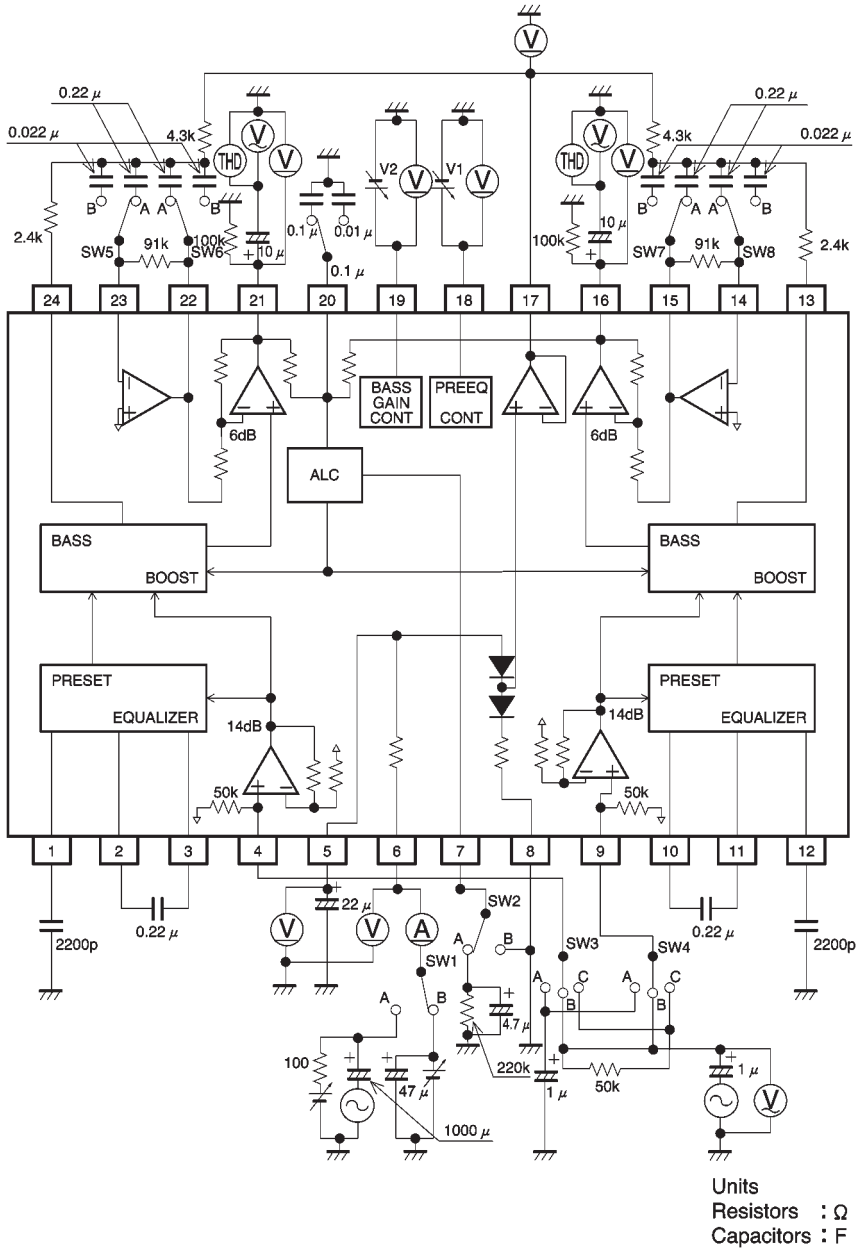

Fig.1

●Circuit operation

(1) Operating power supply voltage range

Within the operating power supply voltage range, circuit functioning is guaranteed as long as the operating temperature range is not exceeded. However, verify carefully that the voltage, temperature, and component values are appropriate.

(2) Control pins and control voltage settings

1) The DC control range is 0 V to V_{CC} for the preset equalizer and the dynamic bass boost control pins (pins 18 and 19). Make sure that the voltage applied to these control pins does not exceed V_{CC}.

2) Mode switch threshold values are determined by dividing resistors between V_{CC} and GND of both the preset equalizer and bass boost. If the control voltages are divided from the supply voltage of the IC, they will have greater tolerance with respect to V_{CC} fluctuations.

3) During mode switching, an abrupt change in the level of the DC output may occur, causing a sound. In this case, add the capacitor and resistor indicated in the application, or only the capacitor as needed.

4) Here is an example of determining the control pin voltage setting with the input of three values.

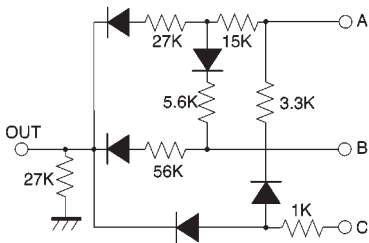

Connect OUT to the control pin.

Regarding the values of the various constants, it is important to consider current dissipation and other such problems. If such a problem should occur, change the constants and redesign the diode logic.

| OUT | C | B | A |
|-------|---|---|---|
| 0 V | L | L | L |
| 1.3 V | L | L | H |
| 3 V | L | H | L |
| 5 V | L | H | H |
| 7 V | H | L | L |
| 9 V | H | L | H |

L : 0V
H : V_{CC}

(3) Input coupling capacitors

Note that the polarity of the input coupling capacitors will change depending on the DC voltage to which they are connected. Set capacitors based on the frequency band to be used, taking into consideration the fact that the input impedance is 50kΩ.

(4) Load resistances

If the values of the load resistors are too small, the output gain and total harmonic distortion may fluctuate slightly. Take this into consideration when connecting the subsequent stage.

(5) The dynamic bass boost filter is a multi feedback active filter which forms the B.P.F.

F₀ can be changed with the C value.

$$f_0 = 1 / [2\pi \times \{(R_1 // R_2) \times R_3 \times C_1 \times C_2\}^{1/2}]$$

$$Q = 1 / 2 \times \{(R_3 / (R_1 // R_2))^{1/2}$$

$$H_0 = R_3 / \{R_1 \times (1 + C_1 / C_2)^{1/2}\}$$

When R₁ = 2.4kΩ, R₂ = 4.3kΩ, R₃ = 91kΩ, and C₁ = C₂ = 0.22μF,

$$f_0 \cong 61\text{Hz} \quad Q \cong 3.8 \quad H_0 \cong 19$$

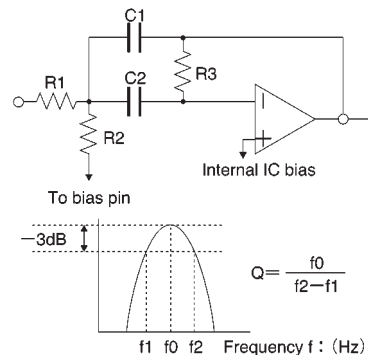

If R₁ and R₂ are too small, the bass boost characteristics such as boost gain and crosstalk may change. Keep this in mind when setting filter values. Furthermore, design the application so that the bass boost level increments by 5dB from 5 to 20dB when H₀ = 19.

(6) Filter for preset equalizer

1) Low band

The low cutoff frequency f_c of each mode is given by the following equation :

$$f_c = 1 / 2\pi CR = 1 / (2\pi \times C \times 15.6k\Omega)$$

When $C = 0.22\mu F$,

$$f_c \doteq 46 \text{ (Hz)}$$

The f_c value can be changed to make slight changes in the boost and cutoff gain of each mode.

2) High band

The high cutoff frequencies f_c of each mode are given by the following equation :

$$f_c = 1 / 2\pi CR$$

When $C = 2200pF$,

ROCK : $R = 8.0k\Omega$ $f_c \doteq 9.0 \text{ (kHz)}$

JAZZ : $R = 10.7k\Omega$ $f_c \doteq 6.8 \text{ (kHz)}$

CLASSIC : $R = 14.9k\Omega$ $f_c \doteq 4.8 \text{ (kHz)}$

BGM. POP : $R = 17.4k\Omega$ $f_c \doteq 4.2 \text{ (kHz)}$

The f_c values can be changed to make slight changes in the boost and cutoff gain of each mode.

Note:

If a high or low f_c value is changed, the gains of all modes will change. The gain cannot be changed for only one mode.

(7) ALC

The band of ALC detection can be changed with the value of C_4 . It must be adjusted appropriately for the dynamic bass boost f_0 . In the example application circuit $C_4 = 0.1\mu F$, thus $f_c = 1 / 2\pi C_4 (R_5 // R_6 // R_7)$ $\doteq 160 \text{ (Hz)}$

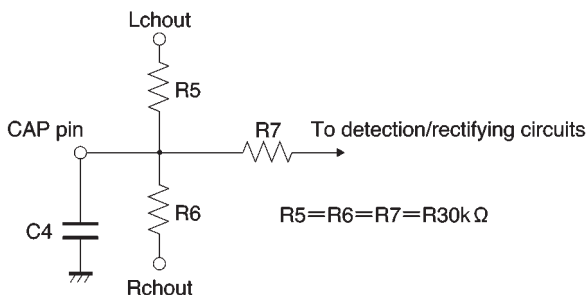

The detection wave is dually rectified. In the example application circuit, it is $1.3V_{rms}$, but if the resistors R_8 and R_9 are connected as shown below, it will lower the ALC level. Adjust the ALC level as needed. The detection band at this time is :

$$f_c = 1 / 2\pi C_4 (R_5 // R_6 // R_7 // R_8 // R_9)$$

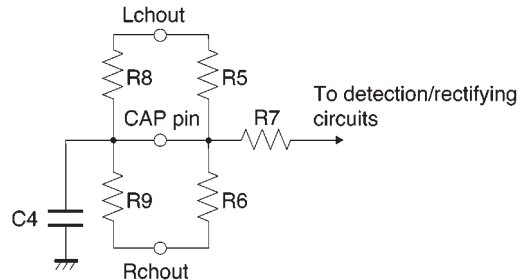

(8) Attack time and release time

Adjust the attack and release times with the resistors and capacitors connected to the ALCC pin. The attack time is determined by R_{10} ($1k\Omega$) and C_5 , and the release time is determined by R_{11} and C_5 . If the value set for C_5 is below $4.7\mu F$, the ALC level may become unstable.

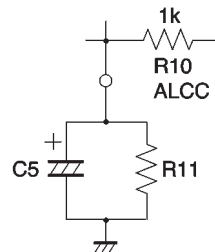

● Electrical characteristic curves (reference values)

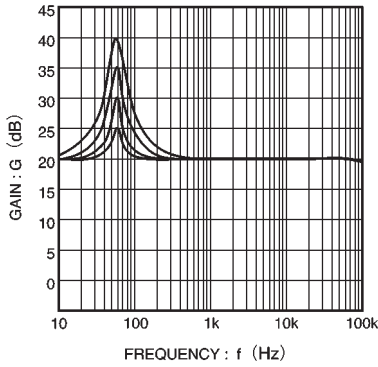

Fig. 2 Dynamic bass boost frequency characteristics

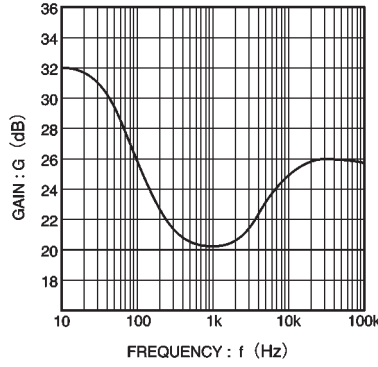

Fig. 3 PRE-G-EQ frequency characteristics (rock)

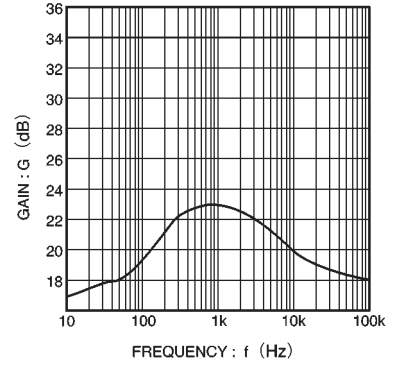

Fig. 4 PRE-G-EQ frequency characteristics (pop)

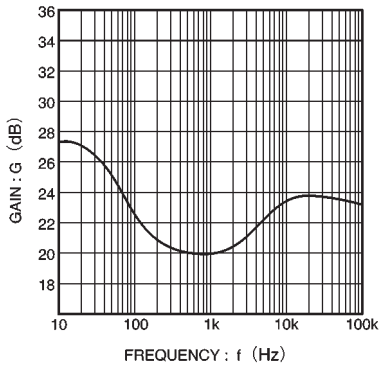

Fig. 5 PRE-G-EQ frequency characteristics (jazz)

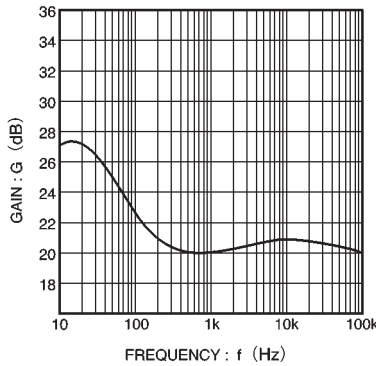

Fig. 6 PRE-G-EQ frequency characteristics (classic)

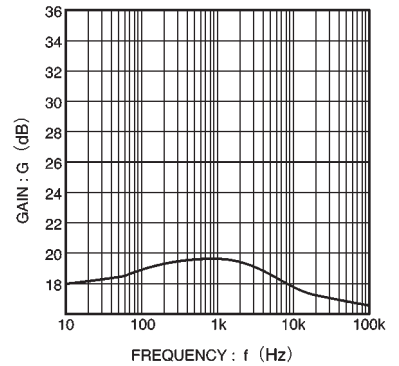

Fig. 7 PRE-G-EQ frequency characteristics (BGM)

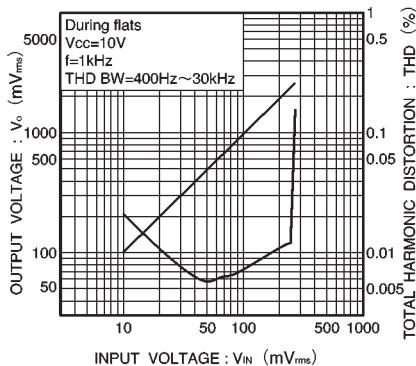

Fig.8 Input/output characteristics

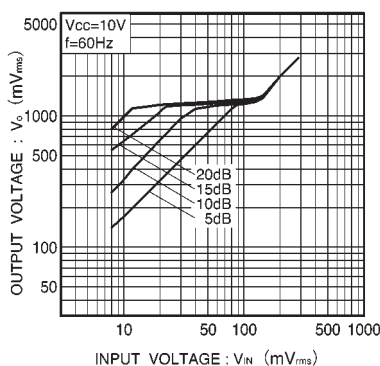

Fig.9 Bass boost ALC input/output characteristics

● External dimensions (Units: mm)

