

8-Pin, 24-Bit, 96 kHz Stereo D/A Converter

Features

- ◆ Complete Stereo DAC System: Interpolation, D/A, Output Analog Filtering
- ◆ 24-Bit Conversion
- ◆ 96 dB Dynamic Range
- ◆ -88 dB THD+N
- ◆ Low Clock-Jitter Sensitivity
- ◆ Single +5 V Power Supply
- ◆ Filtered Line-Level Outputs
- ◆ On-Chip Digital De-emphasis
- ◆ Popguard® Technology
- ◆ Functionally Compatible with CS4330/31/33

Description

The CS4334 family members are complete, stereo digital-to-analog output systems including interpolation, 1-bit D/A conversion and output analog filtering in an 8-pin package. The CS4334/5/8/9 support all major audio data interface formats, and the individual devices differ only in the supported interface format.

The CS4334 family is based on Delta-Sigma modulation, where the modulator output controls the reference voltage input to an ultra-linear analog low-pass filter. This architecture allows for infinite adjustment of sample rate between 2 kHz and 100 kHz simply by changing the master clock frequency.

The CS4334 family contains on-chip digital de-emphasis, operates from a single +5V power supply, and requires minimal support circuitry. These features are ideal for set-top boxes, DVD players, SVCD players, and A/V receivers.

ORDERING INFORMATION

See ["Ordering Information" on page 24](#)

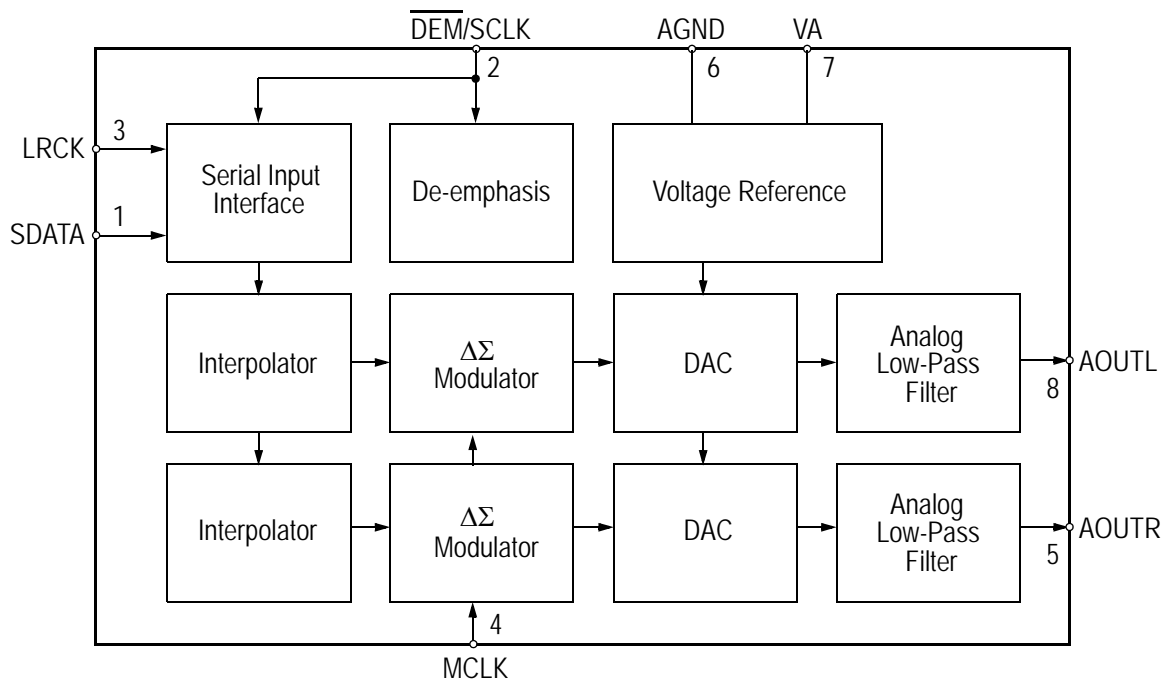

TABLE OF CONTENTS

| | |
|--|-----------|
| 1. TYPICAL CONNECTION DIAGRAM | 4 |
| 2. CHARACTERISTICS AND SPECIFICATIONS | 5 |
| SPECIFIED OPERATING CONDITIONS | 5 |
| ABSOLUTE MAXIMUM RATINGS | 5 |
| ANALOG CHARACTERISTICS | 6 |
| POWER AND THERMAL CHARACTERISTICS | 8 |
| DIGITAL INPUT CHARACTERISTICS | 9 |
| SWITCHING CHARACTERISTICS | 10 |
| 3. GENERAL DESCRIPTION | 12 |
| 3.1 Digital Interpolation Filter | 12 |
| 3.2 Delta-Sigma Modulator | 12 |
| 3.3 Switched-Capacitor DAC | 12 |
| 3.4 Analog Low-Pass Filter | 12 |
| 4. SYSTEM DESIGN | 13 |
| 4.1 Master Clock | 13 |
| 4.2 Serial Clock | 13 |
| 4.2.1 External Serial Clock Mode | 13 |
| 4.2.2 Internal Serial Clock Mode | 13 |
| 4.3 De-Emphasis | 14 |
| 4.4 Initialization and Power-Down | 14 |
| 4.5 Output Transient Control | 14 |
| 4.6 Grounding and Power Supply Decoupling | 15 |
| 4.7 Analog Output and Filtering | 15 |
| 4.8 Overall Base-Rate Frequency Response | 18 |
| 4.9 Overall High-Rate Frequency Response | 19 |
| 4.10 Base Rate Mode Performance Plots | 20 |
| 4.11 High Rate Mode Performance Plots | 21 |
| 5. PARAMETER DEFINITIONS | 22 |
| 6. REFERENCES | 22 |
| 7. PACKAGE DIMENSIONS | 23 |
| 8. ORDERING INFORMATION | 24 |
| 9. FUNCTIONAL COMPATIBILITY | 24 |
| 10. REVISION HISTORY | 25 |

LIST OF FIGURES

| | |
|--|----|
| Figure 1. Recommended Connection Diagram | 4 |
| Figure 2. Output Test Load | 8 |
| Figure 3. Maximum Loading | 9 |
| Figure 4. Power vs. Sample Rate | 9 |
| Figure 5. External Serial Mode Input Timing | 11 |
| Figure 6. Internal Serial Mode Input Timing | 11 |
| Figure 7. Internal Serial Clock Generation | 11 |
| Figure 8. System Block Diagram | 12 |
| Figure 9. De-Emphasis Curve ($F_s = 44.1\text{kHz}$) | 14 |
| Figure 10. CS4334 Data Format (I ² S) | 15 |
| Figure 11. CS4335 Data Format | 15 |
| Figure 12. CS4338 Data Format | 16 |
| Figure 13. CS4339 Data Format | 16 |
| Figure 14. CS4334/5/8/9 Initialization and Power-Down Sequence | 17 |
| Figure 15. Stopband Rejection | 18 |
| Figure 16. Transition Band | 18 |
| Figure 17. Transition Band | 18 |

| | |
|--|----|
| Figure 18. Passband Ripple..... | 18 |
| Figure 19. Stopband Rejection..... | 19 |
| Figure 20. Transition Band..... | 19 |
| Figure 21. Transition Band..... | 19 |
| Figure 22. Passband Ripple..... | 19 |
| Figure 23. 0 dBFS FFT (BRM)..... | 20 |
| Figure 24. -60 dBFS FFT (BRM)..... | 20 |
| Figure 25. Idle Channel Noise FFT (BRM)..... | 20 |
| Figure 26. Twin Tone IMD FFT (BRM)..... | 20 |
| Figure 27. THD+N vs. Amplitude (BRM)..... | 20 |
| Figure 28. THD+N vs. Frequency (BRM)..... | 20 |
| Figure 29. 0 dBFS FFT (HRM)..... | 21 |
| Figure 30. -60 dBFS FFT (HRM)..... | 21 |
| Figure 31. Idle Channel Noise FFT (HRM)..... | 21 |
| Figure 32. Twin Tone IMD FFT (HRM)..... | 21 |
| Figure 33. THD+N vs. Amplitude (HRM)..... | 21 |
| Figure 34. THD+N vs. Frequency (HRM)..... | 21 |

LIST OF TABLES

| | |
|---|----|
| Table 1. Common Clock Frequencies | 13 |
|---|----|

PIN DESCRIPTIONS

| | | | | | |
|--------------------|-----------------|---|---|--------------|-----------------------------|
| SERIAL DATA INPUT | SDATA | 1 | 8 | AOUTL | ANALOG LEFT CHANNEL OUTPUT |
| DE-EMPHASIS / SCLK | DEM/SCLK | 2 | 7 | VA | ANALOG POWER |
| LEFT / RIGHT CLOCK | LRCK | 3 | 6 | AGND | ANALOG GROUND |
| MASTER CLOCK | MCLK | 4 | 5 | AOUTR | ANALOG RIGHT CHANNEL OUTPUT |

| No. | Pin Name | I/O | Pin Function and Description |
|-----|----------|-----|---|
| 1 | SDATA | I | Serial Audio Data Input - Two's complement MSB-first serial data is input on this pin. The data is clocked into the CS4334/5/8/9 via internal or external SCLK, and the channel is determined by LRCK. |
| 2 | DEM/SCLK | I | De-Emphasis/External Serial Clock Input - Used for de-emphasis filter control or external serial clock input. |
| 3 | LRCK | I | Left/Right Clock - Determines which channel is currently being input on the Audio Serial Data Input pin, SDATA. |
| 4 | MCLK | I | Master Clock - Frequency must be 256x, 384x, or 512x the input sample rate in BRM and either 128x or 192x the input sample rate in HRM. |
| 5 | AOUTR | O | Analog Right Channel Output - Typically 3.5 Vp-p for a full-scale input signal. |
| 6 | AGND | I | Analog Ground - Analog ground reference is 0V. |
| 7 | VA | I | Analog Power - Analog power supply is nominally +5 V. |
| 8 | AOUTL | O | Analog Left Channel Output - Typically 3.5 Vp-p for a full-scale input signal. |

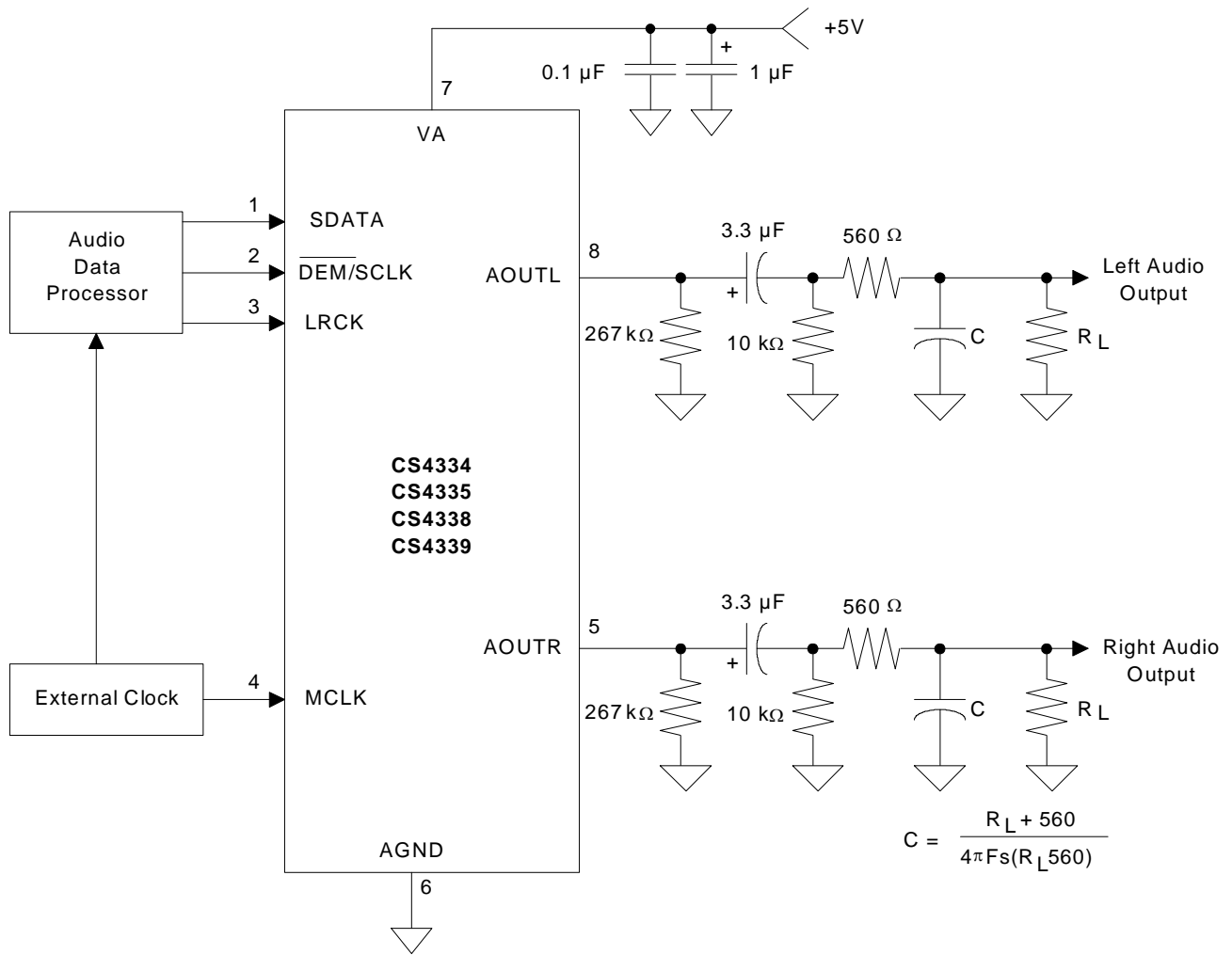
1. TYPICAL CONNECTION DIAGRAM

Figure 1. Recommended Connection Diagram

2. CHARACTERISTICS AND SPECIFICATIONS

(All Min/Max characteristics and specifications are guaranteed over the Specified Operating Conditions. Typical performance characteristics and specifications are derived from measurements taken at nominal supply voltages and $T_A = 25^\circ\text{C}$.)

SPECIFIED OPERATING CONDITIONS

(AGND = 0V; all voltages with respect to ground.)

| Parameters | Symbol | Min | Nom | Max | Units |
|---|--------|------|-----|-----|------------------|
| DC Power Supply | VA | 4.75 | 5.0 | 5.5 | V |
| Ambient Operating Temperature (Power Applied) | T_A | -10 | - | +70 | $^\circ\text{C}$ |
| | | -40 | - | +85 | $^\circ\text{C}$ |

ABSOLUTE MAXIMUM RATINGS

(AGND = 0V; all voltages with respect to ground.)

| Parameters | Symbol | Min | Max | Units |
|---|-----------|------|----------|------------------|
| DC Power Supply | VA | -0.3 | 6.0 | V |
| Input Current, Any Pin Except Supplies | I_{in} | - | ± 10 | mA |
| Digital Input Voltage | V_{IND} | -0.3 | VA+0.4 | V |
| Ambient Operating Temperature (power applied) | T_A | -55 | 125 | $^\circ\text{C}$ |
| Storage Temperature | T_{stg} | -65 | 150 | $^\circ\text{C}$ |

WARNING: Operation at or beyond these limits may result in permanent damage to the device. Normal operation is not guaranteed at these extremes.

ANALOG CHARACTERISTICS

(Full-Scale Output Sine Wave, 997 Hz; Test load $R_L = 10\text{ k}\Omega$, $C_L = 10\text{ pF}$ (see Figure 2). F_s for Base-Rate Mode = 48 kHz, Measurement Bandwidth 10 Hz to 20 kHz, unless otherwise specified; F_s for High-Rate Mode = 96 kHz, Measurement Bandwidth 10 Hz to 40 kHz, unless otherwise specified.)

| Parameter | Symbol | Base-Rate Mode | | | High-Rate Mode | | | Unit |
|--|----------|----------------|-----|-----|----------------|-----|-----|------|
| | | Min | Typ | Max | Min | Typ | Max | |
| Dynamic Performance for CS4334/5/8/9-KSZ, -KZSR | | | | | | | | |
| Dynamic Range | (Note 1) | | | | | | | |
| 18 to 24-Bit | | 88 | 93 | - | - | 90 | - | dB |
| unweighted | | 91 | 96 | - | 91 | 96 | - | dB |
| A-Weighted | | 86 | 91 | - | - | 88 | - | dB |
| 16-Bit | | 89 | 94 | - | 89 | 94 | - | dB |
| unweighted | | | | | | | | |
| A-Weighted | | | | | | | | |
| Total Harmonic Distortion + Noise | (Note 1) | THD+N | | | | | | |
| 18 to 24-Bit | 0 dB | - | -88 | -83 | - | -88 | -83 | dB |
| | -20 dB | - | -73 | -68 | - | -70 | -65 | dB |
| | -60 dB | - | -33 | -28 | - | -30 | -25 | dB |
| 16-Bit | 0 dB | - | -86 | -81 | - | -86 | -81 | dB |
| | -20 dB | - | -71 | -66 | - | -68 | -63 | dB |
| | -60 dB | - | -31 | -26 | - | -28 | -23 | dB |
| Interchannel Isolation | (1 kHz) | - | 94 | - | - | 95 | - | dB |
| Dynamic Performance for CS4334/5/8/9-DSZ, -DSZR | | | | | | | | |
| Dynamic Range | (Note 1) | | | | | | | |
| 18 to 24-Bit | | 85 | 93 | - | - | 90 | - | dB |
| unweighted | | 88 | 96 | - | 88 | 96 | - | dB |
| A-Weighted | | 83 | 91 | - | - | 88 | - | dB |
| 16-Bit | | 86 | 94 | - | 86 | 94 | - | dB |
| unweighted | | | | | | | | |
| A-Weighted | | | | | | | | |
| Total Harmonic Distortion + Noise | (Note 1) | THD+N | | | | | | |
| 18 to 24-Bit | 0 dB | - | -88 | -82 | - | -88 | -82 | dB |
| | -20 dB | - | -73 | -65 | - | -70 | -62 | dB |
| | -60 dB | - | -33 | -25 | - | -30 | -22 | dB |
| 16-Bit | 0 dB | - | -86 | -70 | - | -86 | -80 | dB |
| | -20 dB | - | -71 | -63 | - | -68 | -60 | dB |
| | -60 dB | - | -31 | -23 | - | -28 | -20 | dB |
| Interchannel Isolation | (1 kHz) | - | 94 | - | - | 95 | - | dB |

Notes:

1. One LSB of triangular PDF dither added to data.

ANALOG CHARACTERISTICS (Continued)

| Parameter | Symbol | Base-Rate Mode | | | High-Rate Mode | | | Unit |
|--|---------------|----------------|----------|------------|----------------|----------|-------|------|
| | | Min | Typ | Max | Min | Typ | Max | |
| Combined Digital and On-chip Analog Filter Response (Note 2) | | | | | | | | |
| Passband to -0.05 dB corner to -0.1 dB corner to -3 dB corner | (Note 3) | 0 | - | .4780 | - | - | - | Fs |
| | | - | - | - | 0 | - | .4650 | Fs |
| | | 0 | - | .4996 | 0 | - | .4982 | Fs |
| Frequency Response 10 Hz to 20 kHz | | -.01 | - | +.08 | -.05 | - | +.2 | dB |
| Passband Ripple | | - | - | ±.08 | - | - | ±.2 | dB |
| StopBand | | .5465 | - | - | .5770 | - | - | Fs |
| StopBand Attenuation | (Note 4) | 50 | - | - | 55 | - | - | dB |
| Group Delay | tgd | - | 9/Fs | - | - | 4/Fs | - | s |
| Passband Group Delay Deviation | 0 - 40 kHz | - | ±0.36/Fs | - | - | ±1.39/Fs | - | s |
| | 0 - 20 kHz | - | | - | - | ±0.23/Fs | - | s |
| De-emphasis Error | Fs = 32 kHz | - | - | +1.5/+0 | (Note 5) | | | dB |
| | Fs = 44.1 kHz | - | - | +.05/- .25 | | | | dB |
| | Fs = 48 kHz | - | - | -.2/- .4 | | | | dB |

| Parameters | Symbol | Min | Typ | Max | Units |
|----------------------------|-------------------------|------|-----|------|--------|
| DC Accuracy | | | | | |
| Interchannel Gain Mismatch | | - | 0.1 | 0.4 | dB |
| Gain Error | | - | ±5 | - | % |
| Gain Drift | | - | 100 | - | ppm/°C |
| Analog Output | | | | | |
| Full Scale Output Voltage | | 3.25 | 3.5 | 3.75 | Vpp |
| Quiescent Voltage | V _Q | - | 2.2 | - | VDC |
| Max AC-Load Resistance | (Note 6) R _L | - | 3 | - | kΩ |
| Max Load Capacitance | (Note 6) C _L | - | 100 | - | pF |

Notes:

- Filter response is not tested but is guaranteed by design.
- Response is clock dependent and will scale with Fs. Note that the response plots (Figures 15-22) have been normalized to Fs and can be de-normalized by multiplying the X-axis scale by Fs.
- For Base-Rate Mode, the Measurement Bandwidth is 0.5465 Fs to 3 Fs.
For High-Rate Mode, the Measurement Bandwidth is 0.577 Fs to 1.4 Fs.
- De-emphasis is not available in High-Rate Mode.
- Refer to Figure 3.

POWER AND THERMAL CHARACTERISTICS

| Parameters | | Symbol | Min | Typ | Max | Units |
|------------------------------|------------------------------|---------------|-----|-----|-----|-------------------|
| Power Supplies | | | | | | |
| Power Supply Current | normal operation | I_A | - | 15 | 19 | mA |
| | power-down state | I_A | - | 40 | - | μ A |
| Power Dissipation | (Note 7) normal operation | | - | 75 | 104 | mW |
| | power-down | | - | 0.2 | - | mW |
| Package Thermal Resistance | | θ_{JA} | - | 110 | - | $^{\circ}$ C/Watt |
| Power Supply Rejection Ratio | (1 kHz) | PSRR | - | 79 | - | dB |

Notes:

- Refer to [Figure 4](#). Max Power Dissipation is measured at $V_A=5.5V$.

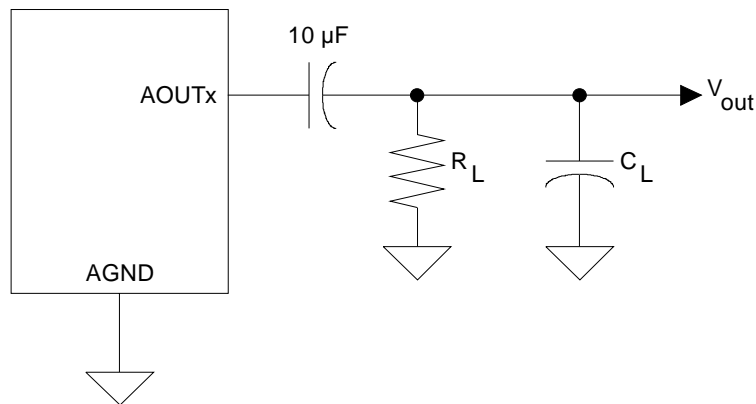
Figure 2. Output Test Load

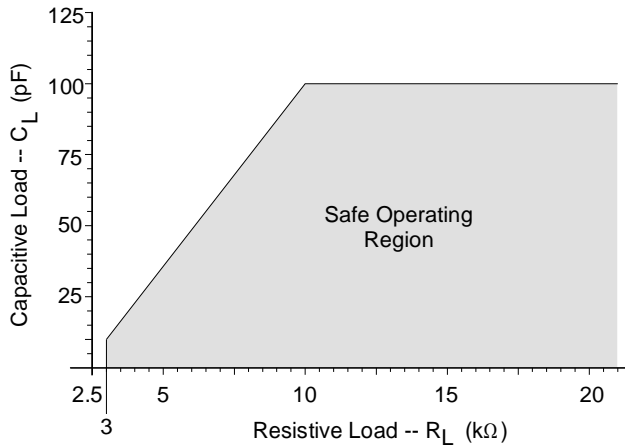
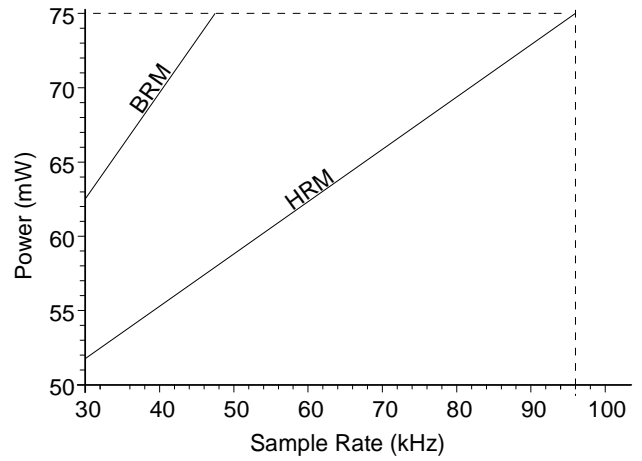
Figure 3. Maximum Loading

Figure 4. Power vs. Sample Rate

DIGITAL INPUT CHARACTERISTICS

| Parameters | Symbol | Min | Typ | Max | Units |
|--------------------------|-------------------|-----|-----|----------|---------|
| High-Level Input Voltage | V_{IH} | 2.0 | - | - | V |
| Low-Level Input Voltage | V_{IL} | - | - | 0.8 | V |
| Input Leakage Current | I_{in} (Note 8) | - | - | ± 10 | μA |
| Input Capacitance | | - | 8 | - | pF |

Notes:

8. I_{in} for CS433X LRCK is $\pm 20\mu A$ max.

SWITCHING CHARACTERISTICS

| Parameters | Symbol | Min | Typ | Max | Units |
|---|--------------------------------|---------------------------|----------------------|------|-------|
| Input Sample Rate | F _s | 2 | - | 100 | kHz |
| MCLK Pulse Width High MCLK/LRCK = 512 | | 10 | - | 1000 | ns |
| MCLK Pulse Width Low MCLK/LRCK = 512 | | 10 | - | 1000 | ns |
| MCLK Pulse Width High MCLK / LRCK = 384 or 192 | | 21 | - | 1000 | ns |
| MCLK Pulse Width Low MCLK / LRCK = 384 or 192 | | 21 | - | 1000 | ns |
| MCLK Pulse Width High MCLK / LRCK = 256 or 128 | | 31 | - | 1000 | ns |
| MCLK Pulse Width Low MCLK / LRCK = 256 or 128 | | 31 | - | 1000 | ns |
| External SCLK Mode | | | | | |
| LRCK Duty Cycle (External SCLK only) | | 40 | 50 | 60 | % |
| SCLK Pulse Width Low | t _{sckl} | 20 | - | - | ns |
| SCLK Pulse Width High | t _{sckh} | 20 | - | - | ns |
| SCLK Period MCLK / LRCK = 512, 256 or 384 Base-Rate Mode | t _{sckw} | $\frac{1}{(128)F_s}$ | - | - | ns |
| SCLK Period MCLK / LRCK = 128 or 192 High-Rate Mode | t _{sckw} | $\frac{1}{(64)F_s}$ | - | - | ns |
| SCLK rising to LRCK edge delay | t _{slrd} | 20 | - | - | ns |
| SCLK rising to LRCK edge setup time | t _{slrs} | 20 | - | - | ns |
| SDATA valid to SCLK rising setup time | t _{sdlrs} | 20 | - | - | ns |
| SCLK rising to SDATA hold time | t _{sdh} | 20 | - | - | ns |
| Internal SCLK Mode | | | | | |
| LRCK Duty Cycle (Internal SCLK only) | (Note 9) | - | 50 | - | % |
| SCLK Period | (Note 10) t _{sckw} | $\frac{1}{SCLK}$ | - | - | ns |
| SCLK rising to LRCK edge | t _{sckr} | - | $\frac{t_{sckw}}{2}$ | - | μs |
| SDATA valid to SCLK rising setup time | t _{sdlrs} | $\frac{1}{(512)F_s} + 10$ | - | - | ns |
| SCLK rising to SDATA hold time MCLK / LRCK = 512, 256 or 128 | t _{sdh} | $\frac{1}{(512)F_s} + 15$ | - | - | ns |
| SCLK rising to SDATA hold time MCLK / LRCK = 384 or 192 | t _{sdh} | $\frac{1}{(384)F_s} + 15$ | - | - | ns |

Notes:

9. In Internal SCLK Mode, the Duty Cycle must be 50% +/- 1/2 MCLK Period.
10. The SCLK / LRCK ratio may be either 32, 48, or 64. This ratio depends on part type and MCLK/LRCK ratio. (See figures [Figures 10-13](#))

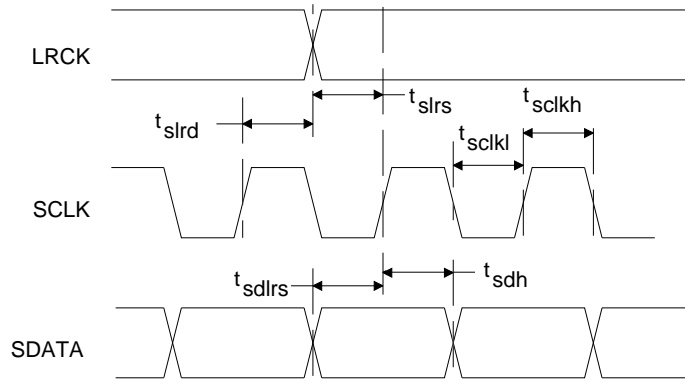

Figure 5. External Serial Mode Input Timing

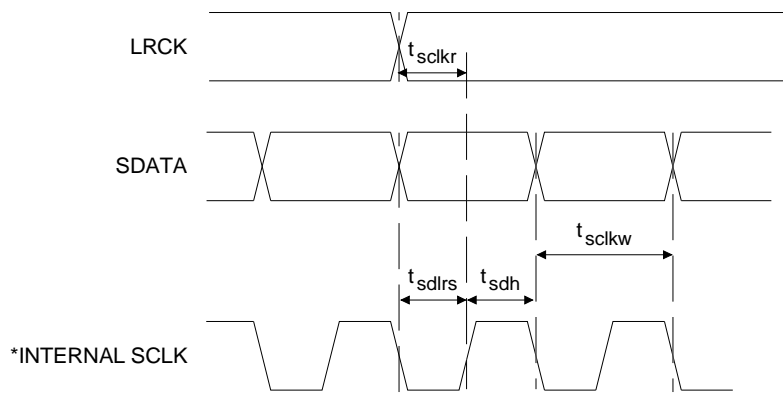

Figure 6. Internal Serial Mode Input Timing

The SCLK pulses shown are internal to the CS4334/5/8/9.

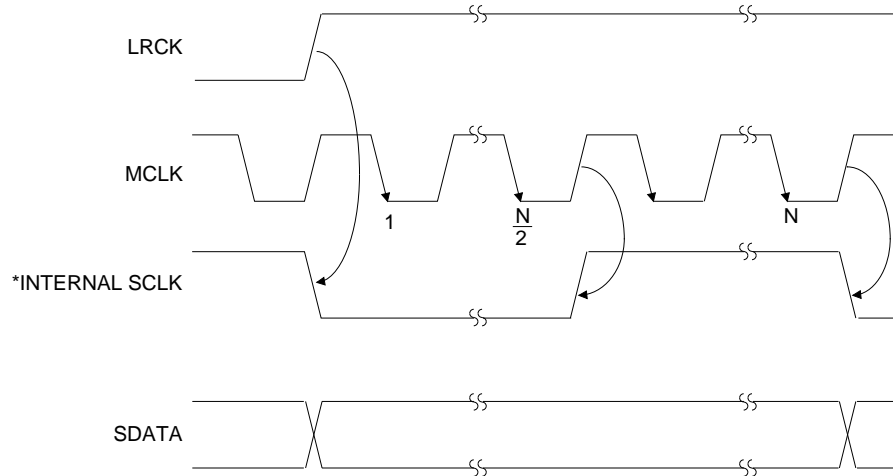

Figure 7. Internal Serial Clock Generation

* The SCLK pulses shown are internal to the CS4334/5/8/9.

N equals MCLK divided by SCLK

3. GENERAL DESCRIPTION

The CS4334 family of devices offers a complete stereo digital-to-analog system including digital interpolation, fourth-order delta-sigma digital-to-analog conversion, digital de-emphasis and analog filtering, as shown in [Figure 8](#). This architecture provides a high tolerance to clock jitter.

The primary purpose of using delta-sigma modulation techniques is to avoid the limitations of resistive laser trimmed digital-to-analog converter architectures by using an inherently linear 1-bit digital-to-analog converter. The advantages of a 1-bit digital-to-analog converter include: ideal differential linearity, no distortion mechanisms due to resistor matching errors and no linearity drift over time and temperature due to variations in resistor values.

The CS4334 family of devices supports two modes of operation. The devices operate in Base Rate Mode (BRM) when MCLK/LRCK is 256, 384 or 512 and in High Rate Mode (HRM) when MCLK/LRCK is 128 or 192. High Rate Mode allows input sample rates up to 100 kHz.

3.1 Digital Interpolation Filter

The digital interpolation filter increases the sample rate, F_s , by a factor of 4 and is followed by a 32x digital sample-and-hold (16x in HRM). This filter eliminates images of the baseband audio signal which exist at multiples of the input sample rate. The resulting frequency spectrum has images of the input signal at multiples of 4 F_s . These images are easily removed by the on-chip analog low-pass filter and a simple external analog filter (see [Figure 1](#)).

3.2 Delta-Sigma Modulator

The interpolation filter is followed by a fourth order delta-sigma modulator which converts the interpolation filter output into 1-bit data at a rate of 128 F_s in BRM (or 64 F_s in HRM).

3.3 Switched-Capacitor DAC

The delta-sigma modulator is followed by a digital-to-analog converter which translates the 1-bit data into a series of charge packets. The magnitude of the charge in each packet is determined by sampling of a voltage reference onto a switched capacitor, where the polarity of each packet is controlled by the 1-bit data. This technique greatly reduces the sensitivity to clock jitter and provides low-pass filtering of the output.

3.4 Analog Low-Pass Filter

The final signal stage consists of a continuous-time low-pass filter which serves to smooth the output and attenuate out-of-band noise.

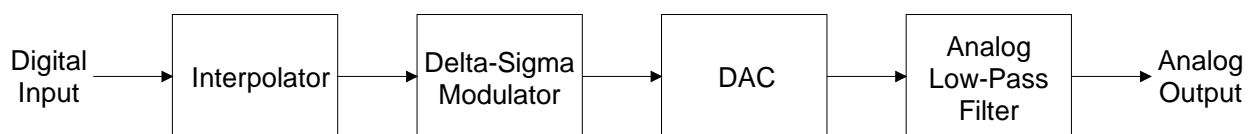

Figure 8. System Block Diagram

4. SYSTEM DESIGN

The CS4334 family accepts data at standard audio sample rates including 48, 44.1 and 32 kHz in BRM and 96, 88.2 and 64 kHz in HRM. Audio data is input via the serial data input pin (SDATA). The Left/Right Clock (LRCK) defines the channel and delineation of data, and the Serial Clock (SCLK) clocks audio data into the input data buffer. The CS4334/5/8/9 differ in serial data formats as shown in [Figures 10-13](#).

4.1 Master Clock

MCLK must be either 256x, 384x or 512x the desired input sample rate in BRM and either 128x or 192x the desired input sample rate in HRM. The LRCK frequency is equal to F_s , the frequency at which words for each channel are input to the device. The MCLK-to-LRCK frequency ratio is detected automatically during the initialization sequence by counting the number of MCLK transitions during a single LRCK period. Internal dividers are set to generate the proper clocks. [Table 1](#) illustrates several standard audio sample rates and the required MCLK and LRCK frequencies. Please note there is no required phase relationship, but MCLK, LRCK and SCLK must be synchronous.

| LRCK (kHz) | MCLK (MHz) | | | | |
|---------------|------------|---------|---------|---------|---------|
| | HRM | | BRM | | |
| | 128x | 192x | 256x | 384x | 512x |
| 32 | 4.0960 | 6.1440 | 8.1920 | 12.2880 | 16.3840 |
| 44.1 | 5.6448 | 8.4672 | 11.2896 | 16.9344 | 22.5792 |
| 48 | 6.1440 | 9.2160 | 12.2880 | 18.4320 | 24.5760 |
| 64 | 8.1920 | 12.2880 | - | - | - |
| 88.2 | 11.2896 | 16.9344 | - | - | - |
| 96 | 12.2880 | 18.4320 | - | - | - |

Table 1. Common Clock Frequencies

4.2 Serial Clock

The serial clock controls the shifting of data into the input data buffers. The CS4334 family supports both external and internal serial clock generation modes. Refer to [Figures 10-13](#) for data formats.

4.2.1 External Serial Clock Mode

The CS4334 family will enter the External Serial Clock Mode when 16 low to high transitions are detected on the DEM/SCLK pin during any phase of the LRCK period. When this mode is enabled, the Internal Serial Clock Mode and de-emphasis filter cannot be accessed. The CS4334 family will switch to Internal Serial Clock Mode if no low to high transitions are detected on the DEM/SCLK pin for 2 consecutive frames of LRCK. Refer to [Figure 14](#).

4.2.2 Internal Serial Clock Mode

In the Internal Serial Clock Mode, the serial clock is internally derived and synchronous with MCLK and LRCK. The SCLK/LRCK frequency ratio is either 32, 48, or 64 depending upon data format. Operation in this mode is identical to operation with an external serial clock synchronized with LRCK. This mode allows access to the digital de-emphasis function. Refer to [Figures 10 - 14](#) for details.

4.3 De-Emphasis

The CS4334 family includes on-chip digital de-emphasis. Figure 9 shows the de-emphasis curve for F_s equal to 44.1 kHz. The frequency response of the de-emphasis curve will scale proportionally with changes in sample rate, F_s .

The de-emphasis filter is active (inactive) if the DEM/SCLK pin is low (high) for 5 consecutive falling edges of LRCK. This function is available only in the internal serial clock mode.

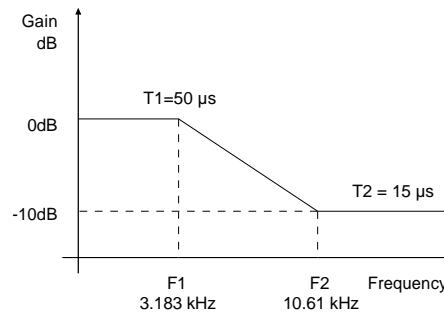

Figure 9. De-Emphasis Curve ($F_s = 44.1\text{kHz}$)

4.4 Initialization and Power-Down

The Initialization and Power-Down sequence flow chart is shown in Figure 14. The CS4334 family enters the Power-Down State upon initial power-up. The interpolation filters and delta-sigma modulators are reset, and the internal voltage reference, one-bit digital-to-analog converters and switched-capacitor low-pass filters are powered down. The device will remain in the Power-Down mode until MCLK and LRCK are present. Once MCLK and LRCK are detected, MCLK occurrences are counted over one LRCK period to determine the MCLK/LRCK frequency ratio. Power is then applied to the internal voltage reference. Finally, power is applied to the D/A converters and switched-capacitor filters, and the analog outputs will ramp to the quiescent voltage, V_Q .

4.5 Output Transient Control

The CS4334 family uses Popguard® technology to minimize the effects of output transients during power-up and power-down. This technique eliminates the audio transients commonly produced by single-ended single-supply converters when it is implemented with external DC-blocking capacitors connected in series with the audio outputs. To make best use of this feature, it is necessary to understand its operation.

When the device is initially powered-up, the audio outputs, AOUTL and AOUTR, are clamped to AGND. After a short delay of approximately 1000 sample periods, each output begins to ramp towards its quiescent voltage, V_Q . Approximately 10,000 sample cycles later, the outputs reach V_Q and audio output begins. This gradual voltage ramping allows time for the external DC-blocking capacitor to charge to V_Q , effectively blocking the quiescent DC voltage.

To prevent transients at power-down, the device must first enter its power-down state. This is accomplished by removing MCLK or LRCK. When this occurs, audio output ceases and the internal output buffers are disconnected from AOUTL and AOUTR. A soft-start current sink is substituted in place of AOUTL and AOUTR which allows the DC-blocking capacitors to slowly discharge. Once this charge is dissipated, the power to the device may be turned off, and the system is ready for the next power-on.

To prevent an audio transient at the next power-on, the DC-blocking capacitors must fully discharge before turning off the power or exiting the power-down state. If full discharge does not occur, a transient will occur when the audio outputs are initially clamped to AGND. The time that the device must remain in the power-

down state is related to the value of the DC-blocking capacitance. For example, with a 3.3 μ F capacitor, the time that the device must remain in the power-down state will be approximately 0.4 seconds.

4.6 Grounding and Power Supply Decoupling

As with any high resolution converter, the CS4334 family requires careful attention to power supply and grounding arrangements to optimize performance. Figure 1 shows the recommended power arrangement with VA connected to a clean +5V supply. For best performance, decoupling capacitors should be located as close to the device package as possible with the smallest capacitor closest.

4.7 Analog Output and Filtering

The analog filter present in the CS4334 family is a switched-capacitor filter followed by a continuous time low pass filter. Its response, combined with that of the digital interpolator, is given in Figures 15 - 22.

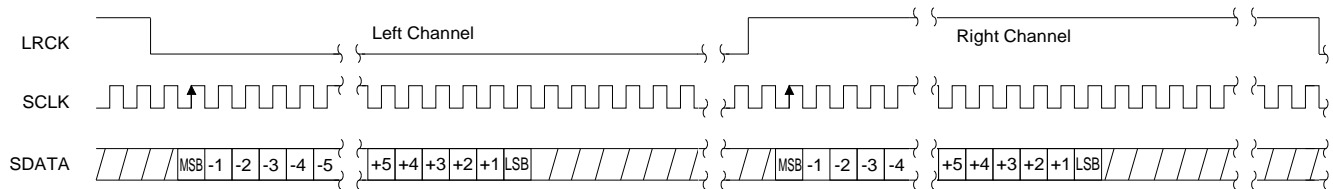

| Internal SCLK Mode | External SCLK Mode |
|---|--|
| I ² S, 16-Bit data and INT SCLK = 32 Fs if MCLK/LRCK = 512, 256 or 128 I ² S, Up to 24-Bit data and INT SCLK = 48 Fs if MCLK/LRCK = 384 or 192 | I ² S, up to 24-Bit Data Data Valid on Rising Edge of SCLK |

Figure 10. CS4334 Data Format (I²S)

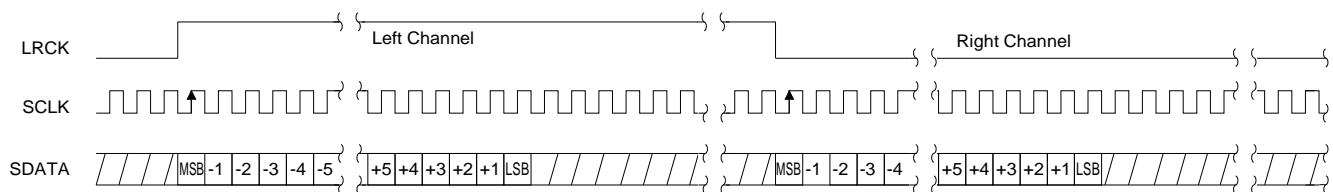

| Internal SCLK Mode | External SCLK Mode |
|--|--|
| Left Justified, up to 24-Bit Data INT SCLK = 64 Fs if MCLK/LRCK = 512, 256 or 128 INT SCLK = 48 Fs if MCLK/LRCK = 384 or 192 | Left Justified, up to 24-Bit Data Data Valid on Rising Edge of SCLK |

Figure 11. CS4335 Data Format

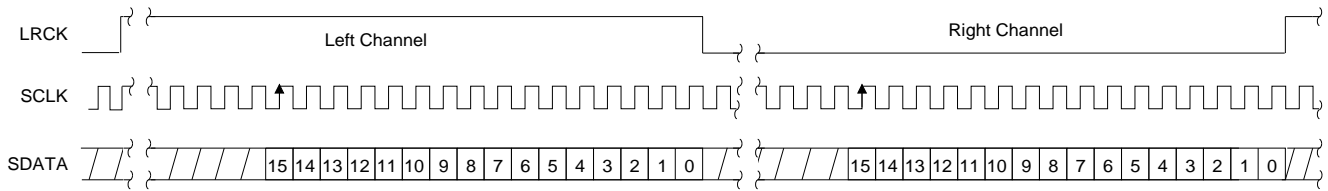

| Internal SCLK Mode | External SCLK Mode |
|---|--|
| Right Justified, 16-Bit Data INT SCLK = 32 Fs if MCLK/LRCK = 512, 256 or 128 INT SCLK = 48 Fs if MCLK/LRCK = 384 or 192 | Right Justified, 16-Bit Data Data Valid on Rising Edge of SCLK SCLK Must Have at Least 32 Cycles per LRCK Period |

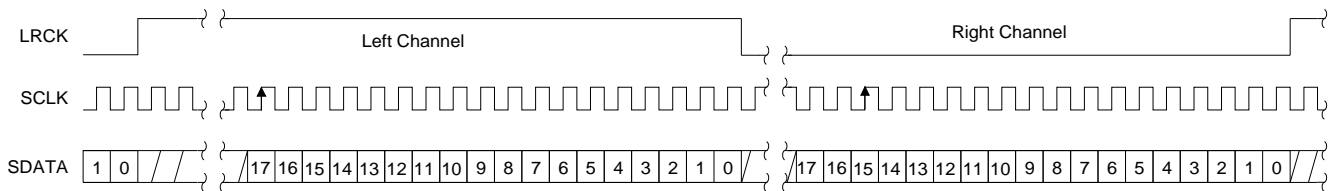
Figure 12. CS4338 Data Format

| Internal SCLK Mode | External SCLK Mode |
|---|--|
| Right Justified, 18-Bit Data INT SCLK = 64 Fs if MCLK/LRCK = 512, 256 or 128 INT SCLK = 48 Fs if MCLK/LRCK = 384 or 192 | Right Justified, 18-Bit Data Data Valid on Rising Edge of SCLK SCLK Must Have at Least 36 Cycles per LRCK Period |

Figure 13. CS4339 Data Format

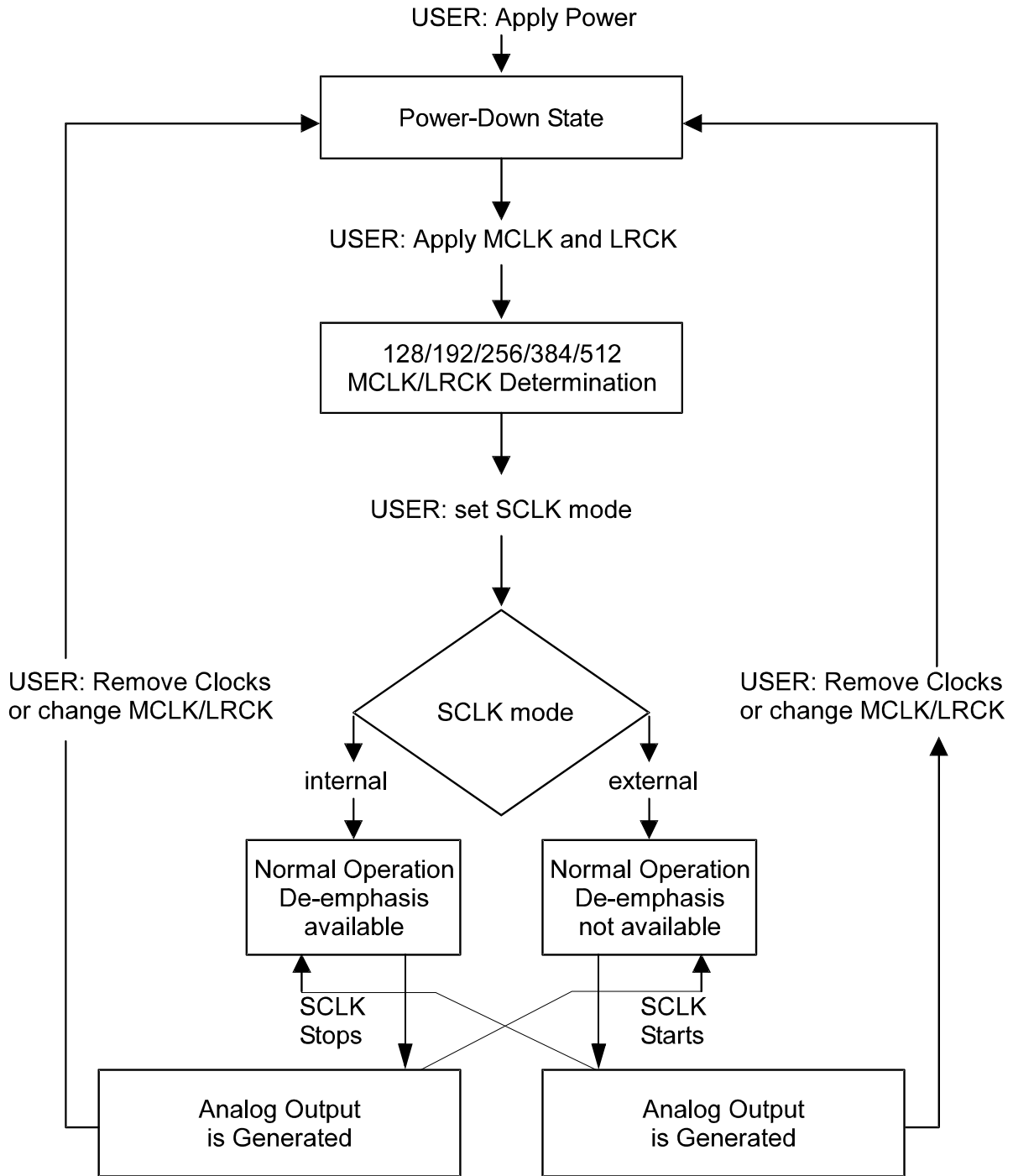

Figure 14. CS4334/5/8/9 Initialization and Power-Down Sequence

4.8 Overall Base-Rate Frequency Response

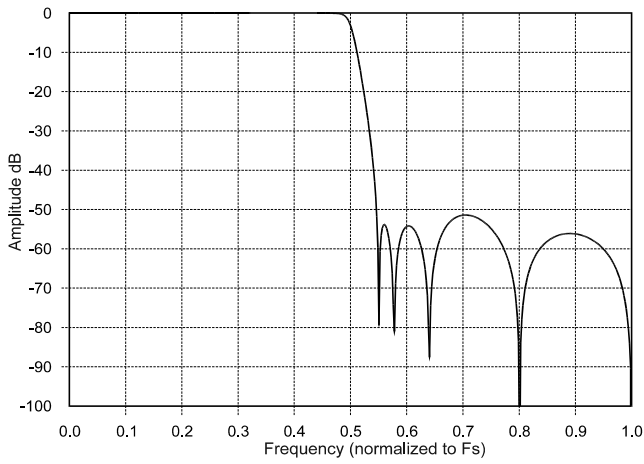

Figure 15. Stopband Rejection

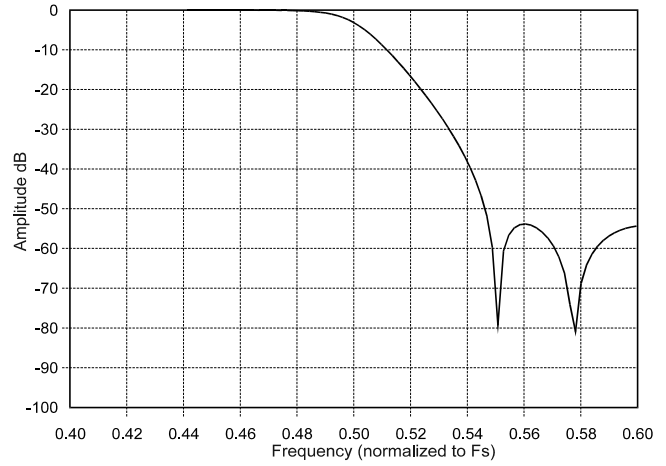

Figure 16. Transition Band

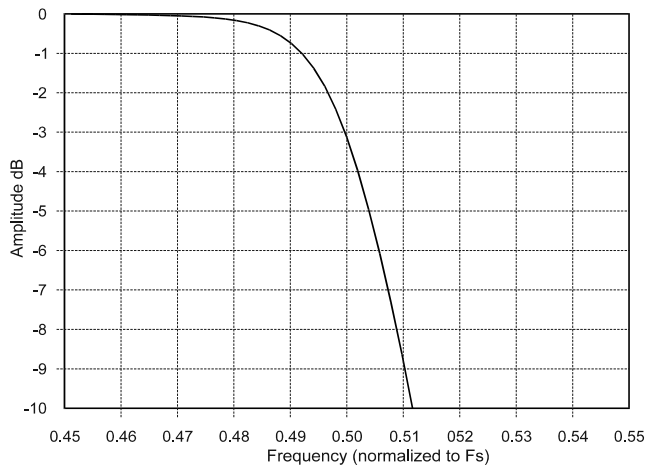

Figure 17. Transition Band

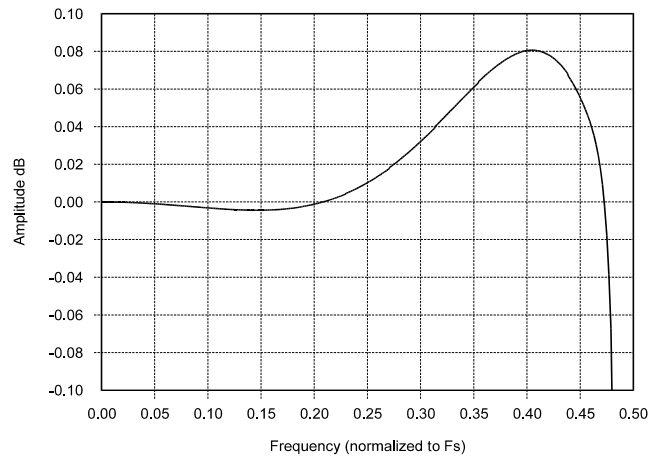

Figure 18. Passband Ripple

4.9 Overall High-Rate Frequency Response

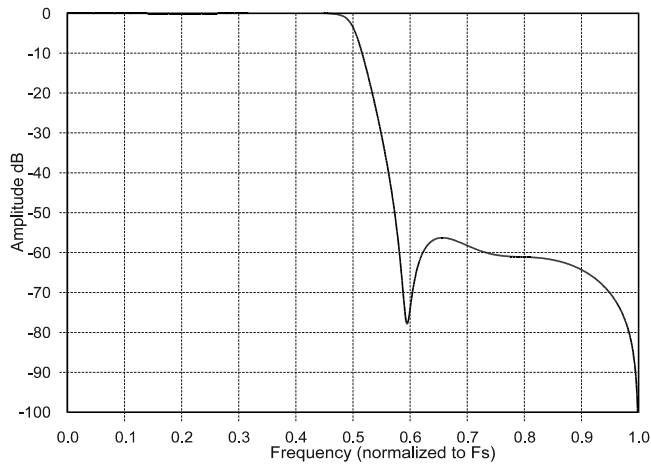

Figure 19. Stopband Rejection

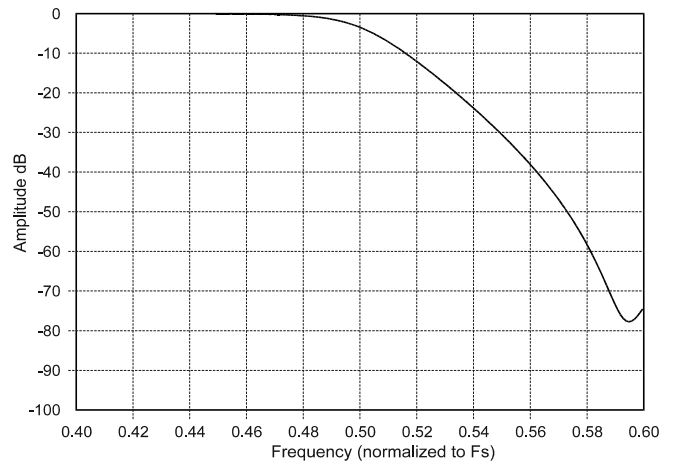

Figure 20. Transition Band

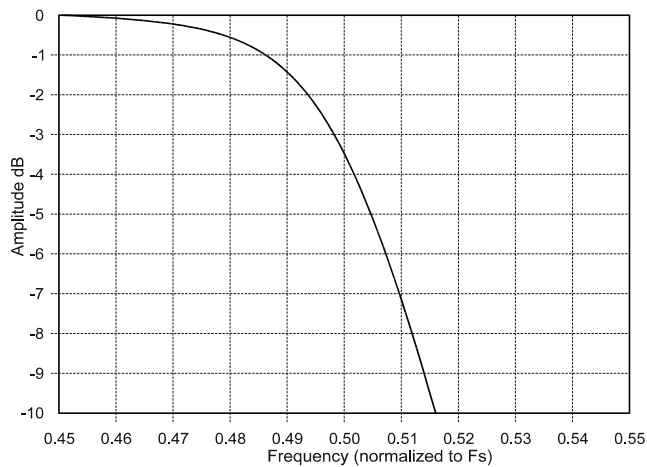

Figure 21. Transition Band

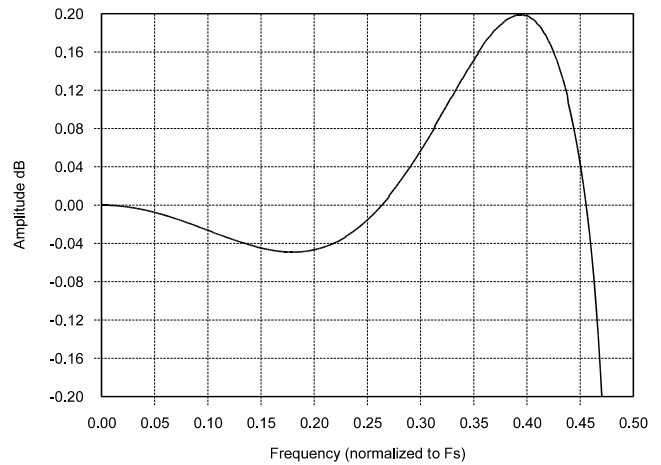
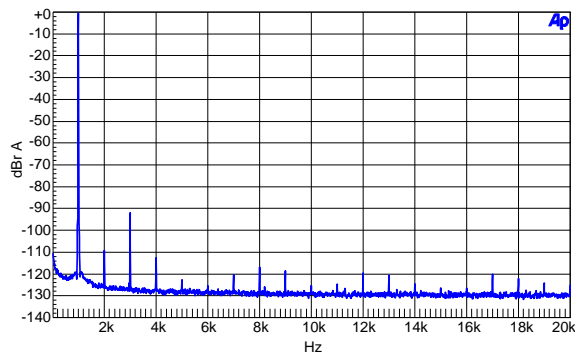

Figure 22. Passband Ripple

4.10 Base Rate Mode Performance Plots



(16k FFT of a 1 kHz input signal)

Figure 23. 0 dBFS FFT (BRM)

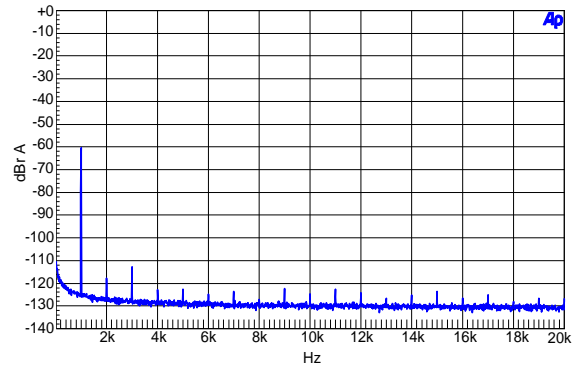

(16k FFT of a 1 kHz input signal)

Figure 24. -60 dBFS FFT (BRM)

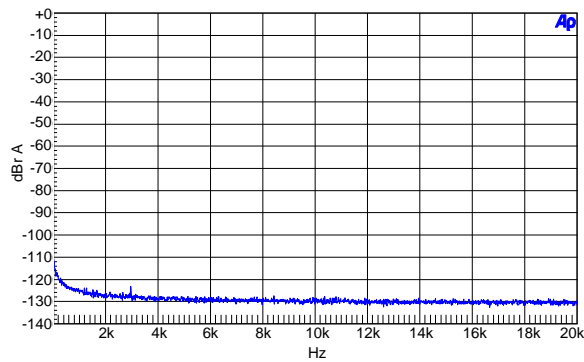

(16k FFT with no input signal)

Figure 25. Idle Channel Noise FFT (BRM)

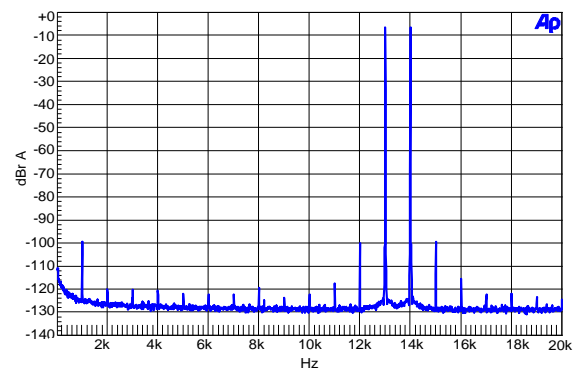

(16k FFT of intermodulation distortion using 13 kHz and 14 kHz input signals)

Figure 26. Twin Tone IMD FFT (BRM)

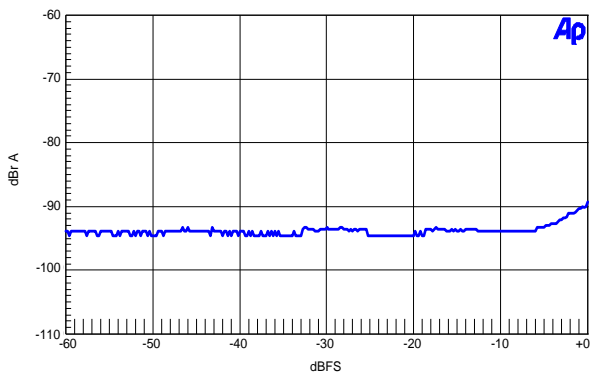

(THD+N plots measured using a 1kHz 24-bit dithered input signal)

Figure 27. THD+N vs. Amplitude (BRM)

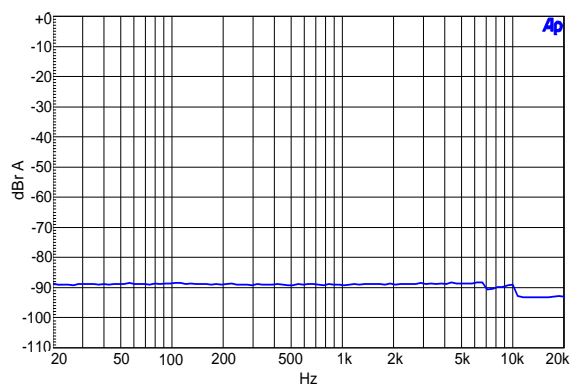

(THD+N plots measured using a 1kHz 24-bit dithered input signal)

Figure 28. THD+N vs. Frequency (BRM)

All measurements were taken from the CDB4334 evaluation board using the Audio Precision Dual Domain System Two Cascade.

4.11 High Rate Mode Performance Plots

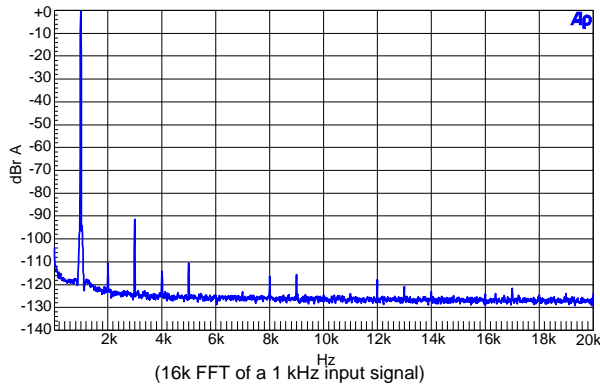

Figure 29. 0 dBFS FFT (HRM)

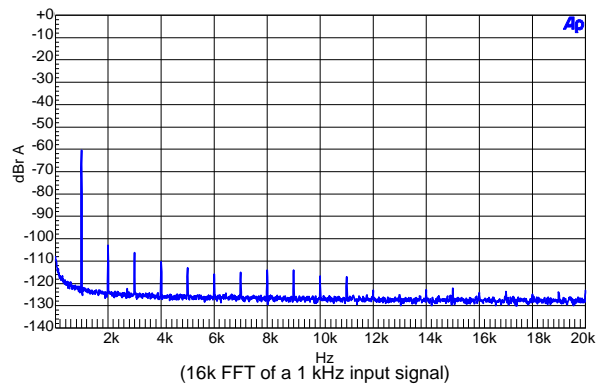

Figure 30. -60 dBFS FFT (HRM)

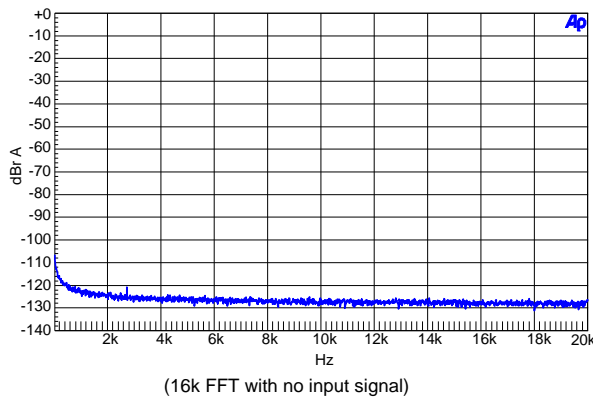

Figure 31. Idle Channel Noise FFT (HRM)

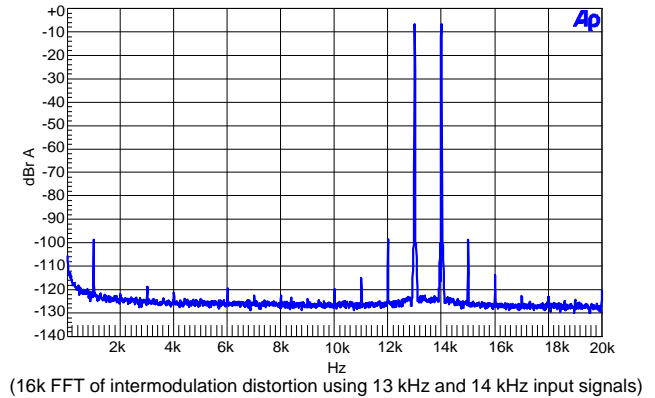

Figure 32. Twin Tone IMD FFT (HRM)

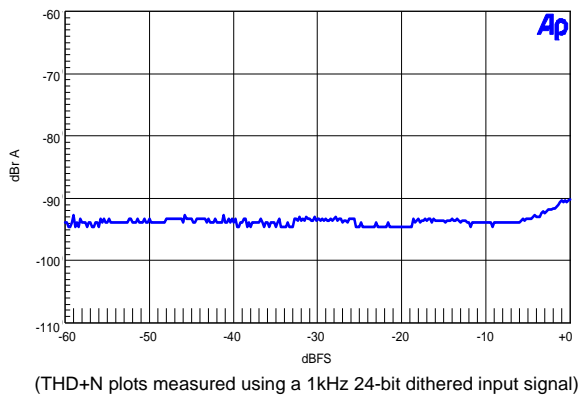

Figure 33. THD+N vs. Amplitude (HRM)

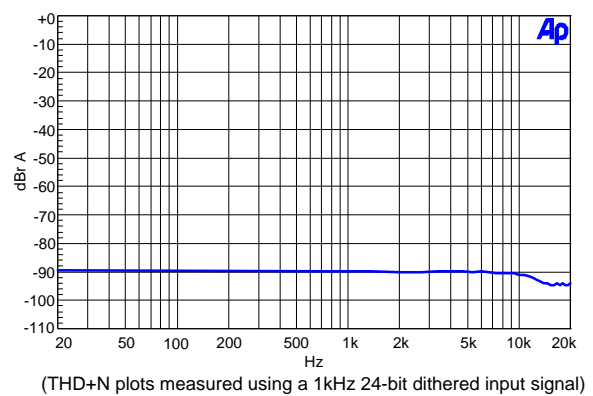

Figure 34. THD+N vs. Frequency (HRM)

All measurements were taken from the CDB4334 evaluation board using the Audio Precision Dual Domain System Two Cascade.

5. PARAMETER DEFINITIONS

Total Harmonic Distortion + Noise (THD+N)

The ratio of the rms value of the signal to the rms sum of all other spectral components over the specified bandwidth (typically 10Hz to 20kHz), including distortion components. Expressed in decibels.

Dynamic Range

The ratio of the full scale rms value of the signal to the rms sum of all other spectral components over the specified bandwidth. Dynamic range is a signal-to-noise measurement over the specified bandwidth made with a -60 dBFS signal. 60 dB is then added to the resulting measurement to refer the measurement to full scale. This technique ensures that the distortion components are below the noise level and do not effect the measurement. This measurement technique has been accepted by the Audio Engineering Society, AES17-1991, and the Electronic Industries Association of Japan, EIAJ CP-307.

Interchannel Isolation

A measure of crosstalk between the left and right channels. Measured for each channel at the converter's output with all zeros to the input under test and a full-scale signal applied to the other channel. Units in decibels.

Interchannel Gain Mismatch

The gain difference between left and right channels. Units in decibels.

Gain Error

The deviation from the nominal full-scale analog output for a full-scale digital input.

Gain Drift

The change in gain value with temperature. Units in ppm/°C.

6. REFERENCES

1. "How to Achieve Optimum Performance from Delta-Sigma A/D & D/A Converters" by Steven Harris. Paper presented at the 93rd Convention of the Audio Engineering Society, October 1992.
2. CDB4334/5/8/9 Evaluation Board Datasheet

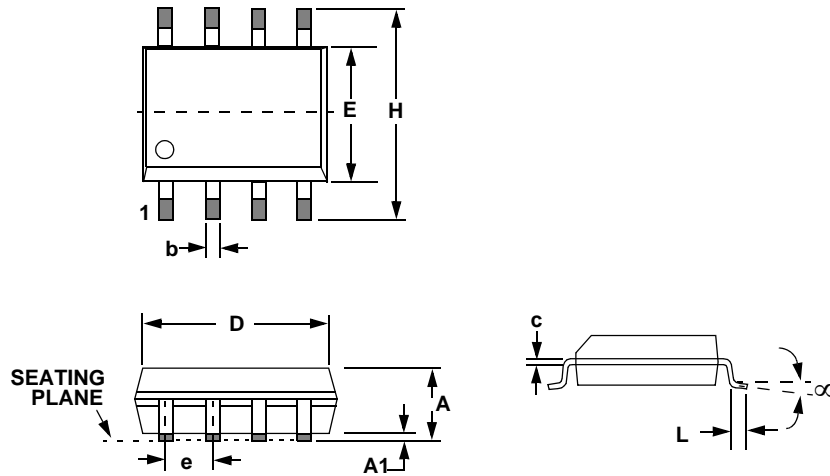
7. PACKAGE DIMENSIONS
8L SOIC (150 MIL BODY) PACKAGE DRAWING

| DIM | INCHES | | MILLIMETERS | |
|----------|--------|-------|-------------|------|
| | MIN | MAX | MIN | MAX |
| A | 0.053 | 0.069 | 1.35 | 1.75 |
| A1 | 0.004 | 0.010 | 0.10 | 0.25 |
| b | 0.013 | 0.020 | 0.33 | 0.51 |
| c | 0.007 | 0.010 | 0.19 | 0.25 |
| D | 0.189 | 0.197 | 4.80 | 5.00 |
| E | 0.150 | 0.157 | 3.80 | 4.00 |
| e | 0.040 | 0.060 | 1.02 | 1.52 |
| H | 0.228 | 0.244 | 5.80 | 6.20 |
| L | 0.016 | 0.050 | 0.40 | 1.27 |
| ∞ | 0° | 8° | 0° | 8° |

JEDEC # : MS-012

8. ORDERING INFORMATION

| Model | Temperature | Package | Container | Serial Interface |
|-------------|---------------|-------------------------------|-------------|---|
| CS4334-KSZ | -10 to +70 °C | 8-pin Plastic SOIC, lead free | Rail | 16 to 24-bit, I ² S |
| CS4335-KSZ | -10 to +70 °C | 8-pin Plastic SOIC, lead free | Rail | 16 to 24-bit, left justified |
| CS4338-KSZ | -10 to +70 °C | 8-pin Plastic SOIC, lead free | Rail | 16-bit, right justified |
| CS4339-KSZ | -10 to +70 °C | 8-pin Plastic SOIC, lead free | Rail | 18-bit, right justified, 32 F _s Internal SCLK mode |
| CS4334-KSZR | -10 to +70 °C | 8-pin Plastic SOIC, lead free | Tape & reel | 16 to 24-bit, I ² S |
| CS4335-KSZR | -10 to +70 °C | 8-pin Plastic SOIC, lead free | Tape & reel | 16 to 24-bit, left justified |
| CS4338-KSZR | -10 to +70 °C | 8-pin Plastic SOIC, lead free | Tape & reel | 16-bit, right justified |
| CS4339-KSZR | -10 to +70 °C | 8-pin Plastic SOIC, lead free | Tape & reel | 18-bit, right justified, 32 F _s Internal SCLK mode |
| CS4334-DSZ | -40 to +85 °C | 8-pin Plastic SOIC, lead free | Rail | 16 to 24-bit, I ² S |
| CS4335-DSZ | -40 to +85 °C | 8-pin Plastic SOIC, lead free | Rail | 16 to 24-bit, left justified |
| CS4338-DSZ | -40 to +85 °C | 8-pin Plastic SOIC, lead free | Rail | 16-bit, right justified |
| CS4339-DSZ | -40 to +85 °C | 8-pin Plastic SOIC, lead free | Rail | 18-bit, right justified, 32 F _s Internal SCLK mode |
| CS4334-DSZR | -40 to +85 °C | 8-pin Plastic SOIC, lead free | Tape & reel | 16 to 24-bit, I ² S |
| CS4335-DSZR | -40 to +85 °C | 8-pin Plastic SOIC, lead free | Tape & reel | 16 to 24-bit, left justified |
| CS4338-DSZR | -40 to +85 °C | 8-pin Plastic SOIC, lead free | Tape & reel | 16-bit, right justified |
| CS4339-DSZR | -40 to +85 °C | 8-pin Plastic SOIC, lead free | Tape & reel | 18-bit, right justified, 32 F _s Internal SCLK mode |

9. FUNCTIONAL COMPATIBILITY

CS4330-KS ⇒ CS4339-KSZx
 CS4331-KS ⇒ CS4334-KSZx
 CS4333-KS ⇒ CS4338-KSZx
 CS4330-BS ⇒ CS4339-DSZx
 CS4331-BS ⇒ CS4334-DSZx
 CS4333-BS ⇒ CS4338-DSZx

10. REVISION HISTORY

| Revision | Changes |
|----------|--|
| F5 | Corrected "B" to "b" and "C" to "c" to match drawing in "Package Dimensions" on page 23 Updated legal text |
| F6 | Changed "One-half LSB..." to "One LSB of triangular PDF dither added to data" in footnote to Analog Characteristics specification table. Added tape and reel options to the Ordering Information section and updated references to -KSZ and -DSZ in specification tables to show -KSZR and -DSZR options. |

Contacting Cirrus Logic Support

For all product questions and inquiries, contact a Cirrus Logic Sales Representative.

To find the one nearest you, go to www.cirrus.com.

IMPORTANT NOTICE

Cirrus Logic, Inc. and its subsidiaries ("Cirrus") believe that the information contained in this document is accurate and reliable. However, the information is subject to change without notice and is provided "AS IS" without warranty of any kind (express or implied). Customers are advised to obtain the latest version of relevant information to verify, before placing orders, that information being relied on is current and complete. All products are sold subject to the terms and conditions of sale supplied at the time of order acknowledgment, including those pertaining to warranty, indemnification, and limitation of liability. No responsibility is assumed by Cirrus for the use of this information, including use of this information as the basis for manufacture or sale of any items, or for infringement of patents or other rights of third parties. This document is the property of Cirrus and by furnishing this information, Cirrus grants no license, express or implied under any patents, mask work rights, copyrights, trademarks, trade secrets or other intellectual property rights. Cirrus owns the copyrights associated with the information contained herein and gives consent for copies to be made of the information only for use within your organization with respect to Cirrus integrated circuits or other products of Cirrus. This consent does not extend to other copying such as copying for general distribution, advertising or promotional purposes, or for creating any work for resale.

CERTAIN APPLICATIONS USING SEMICONDUCTOR PRODUCTS MAY INVOLVE POTENTIAL RISKS OF DEATH, PERSONAL INJURY, OR SEVERE PROPERTY OR ENVIRONMENTAL DAMAGE ("CRITICAL APPLICATIONS"). CIRRUS PRODUCTS ARE NOT DESIGNED, AUTHORIZED OR WARRANTED FOR USE IN PRODUCTS SURGICALLY IMPLANTED INTO THE BODY, AUTOMOTIVE SAFETY OR SECURITY DEVICES, LIFE SUPPORT PRODUCTS OR OTHER CRITICAL APPLICATIONS. INCLUSION OF CIRRUS PRODUCTS IN SUCH APPLICATIONS IS UNDERSTOOD TO BE FULLY AT THE CUSTOMER'S RISK AND CIRRUS DISCLAIMS AND MAKES NO WARRANTY, EXPRESS, STATUTORY OR IMPLIED, INCLUDING THE IMPLIED WARRANTIES OF MERCHANTABILITY AND FITNESS FOR PARTICULAR PURPOSE, WITH REGARD TO ANY CIRRUS PRODUCT THAT IS USED IN SUCH A MANNER. IF THE CUSTOMER OR CUSTOMER'S CUSTOMER USES OR PERMITS THE USE OF CIRRUS PRODUCTS IN CRITICAL APPLICATIONS, CUSTOMER AGREES, BY SUCH USE, TO FULLY INDEMNIFY CIRRUS, ITS OFFICERS, DIRECTORS, EMPLOYEES, DISTRIBUTORS AND OTHER AGENTS FROM ANY AND ALL LIABILITY, INCLUDING ATTORNEYS' FEES AND COSTS, THAT MAY RESULT FROM OR ARISE IN CONNECTION WITH THESE USES.

Cirrus Logic, Cirrus, the Cirrus Logic logo designs and Popguard are trademarks of Cirrus Logic, Inc. All other brand and product names in this document may be trademarks or service marks of their respective owners.

Mouser Electronics

Authorized Distributor

Click to View Pricing, Inventory, Delivery & Lifecycle Information:

Cirrus Logic:

[CS4334-DSZ](#) [CS4334-KSZ](#) [CS4334-KSZR](#) [CS4335-KSZ](#) [CS4338-KSZ](#) [CS4338-KSZR](#) [CS4339-KSZR](#) [CS4339-KSZ](#) [CS4334-DSZR](#) [CS4335-KSZR](#) [CS4334-BS](#) [CS4334-DSR](#) [CS4334-BSR](#)