

### Features

- Low Supply Current ,  $I_{DD} = 8\text{mA}$  at Stereo BTL
- Low Shutdown Current ,  $I_{DD} = 0.5\mu\text{A}$
- Depop Circuitry Integrated
- Low Supply Voltage
- Thermal Shutdown Circuitry Integrated
- Output Power at 1% THD+N ,  $V_{DD} = 5\text{V}$ 
  - 1.8 W/Ch (typ) into a 4  $\Omega$  Load
  - 1.2 W/Ch (typ) into a 8  $\Omega$  Load
- Bridge-Tied Load (BTL) or Single-Ended (SE) Modes Operation
- Various 24-Pin Power Packages Available  
SOP , TSSOP-P
- High Supply Voltage Ripple Rejection

### Applications

- Stereo Audio Power Amplifier for Notebook Computer

### General Description

The APA2020A is a stereo bridge-tied audio power amplifier in various 24-pin power packages , including SOP , TSSOP-P. When connecting to a 5V voltage supply , the APA2020A is capable of delivering 1.8W/1.2W of continuous RMS power per channel into 4 $\Omega$ /8 $\Omega$  loads with less than 1% THD+N , respectively. The APA2020A simplifies design and frees up board space for other features .

The APA2020A also served well in low-voltage applications , which provides 800-mW per channel into 4 $\Omega$  loads with a 3.3V supply voltage . Both of the depop circuitry and the thermal shutdown protection circuitry are integrated in the APA2020A , that reduces pops and clicks noise during power up and when using the shutdown or mute modes and protects the chip from being destroyed by over-temperature failure.

To simplify the audio system design in notebook computer applications , the APA2020A combines a stereo bridge-tied loads (BTL) mode for speaker drive and a stereo single-end (SE) mode for headphone drive into a single chip , where both modes are easily switched by the SE/BTL input control pin signal . For power sensitive applications , the APA2020A also features a shutdown function which keeps the supply current only 0.5  $\mu\text{A}$  (typ) .

### Ordering Information

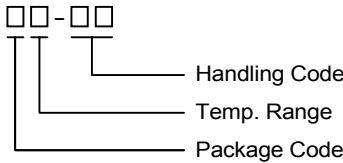
APA2020A 	Package Code K : SOP                      R : TSSOP-P *
	Temp. Range I: - 40 to 85 °C
	Handling Code TU : Tube                      TR : Tape & Reel TY : Tray

\* TSSOP-P is a standard TSSOP package with a thermal pad exposure on the bottom of the package.

ANPEC reserves the right to make changes to improve reliability or manufacturability without notice, and advise customers to obtain the latest version of relevant information to verify before placing orders.

## Block Diagram

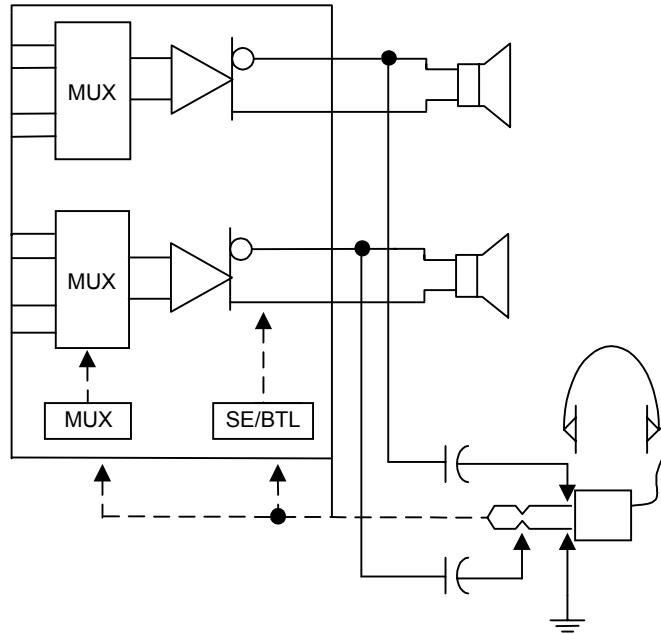

## Absolute Maximum Ratings

(Over operating free-air temperature range unless otherwise noted.)

Symbol	Parameter	Rating	Unit
$V_{CC}$	Supply Voltage	6	V
$T_A$	Operating Ambient Temperature Range	-40 to 85	°C
$T_J$	Maximum Junction Temperature	150	°C
$T_{STG}$	Storage Temperature Range	-65 to +150	°C
$T_S$	Soldering Temperature, 10 seconds	300	°C
$V_{ESD}$	Electrostatic Discharge	-3000 to 3000 <sup>*1</sup> -200 to 200 <sup>*2</sup>	V

Note: 1. Human body model : C=100pF , R=1500Ω , 3 positive pulses plus 3 negative pulses

2. Machine model : C=200pF , L=0.5mH , R=0Ω , 3 positive pulses plus 3 negative pulses

## Recommended Operating Conditions

		Min.	Typ.	Max.	Unit
Supply Voltage, $V_{DD}$		3	5	5.5	V
Operating free-air temperature, $T_A$	$V_{DD}=5V$ , 250mW/Ch average power, 4- $\Omega$ stereo BTL drive, with proper PCB design	-20		85	$^{\circ}C$
	$V_{DD}=5V$ , 2 W/Ch average power, 3- $\Omega$ stereo BTL drive, with proper PCB design and 300 CFM forced-air cooling	-20		85	
Common mode input voltage, $V_{ICM}$	$V_{DD}=5 V$	1.25		4.5	V
	$V_{DD}=3.3V$	1.25		2.7	

## Electrical Characteristics (Cont.)

AC Operating Characteristics,  $V_{DD} = 5V$ ,  $T_A = 25^{\circ}C$ ,  $R_L = 4\Omega$  (unless otherwise noted)

Symbol	Parameter	Test Condition	APA2020A			Unit
			Min.	Typ.	Max.	
P(out)	Output power (each channel ) see Note 1	THD = 10% , BTL , $R_L=4\Omega$		2.3		W
		$R_L=8\Omega$		1.5		
		THD = 1% , BTL , $R_L=4\Omega$		1.8		mW
		$R_L=8\Omega$		1.2		
		THD = 10% , SE , $R_L=4\Omega$		650		
	$R_L=8\Omega$		400			
	THD = 1% , SE , $R_L=4\Omega$		500		mW	
	$R_L=8\Omega$		320			
	THD = 0.5% , SE , $R_L=32 \Omega$		90			
THD + N	Total harmonic distortion plus noise	$P_o = 1.6W$ , BTL , $R_L=4\Omega$		300		m%
		$P_o = 1W$ , BTL , $R_L=8\Omega$		150		
		$P_o = 78mW$ , SE , $R_L=32\Omega$		20		
		$V_1 = 1V$ , $R_L=4\Omega$ , $G = 1$		10		
$B_{OM}$	Maximum output power bandwidth	$G = 10$ , THD < 1%		>20		KHz
	Phase margin	$R_L = 4\Omega$ , BTL		72		$^{\circ}$
		$R_L = 4\Omega$ , Open Load		71		
		$R_L = 4\Omega$ , SE		52		

## Electrical Characteristics (Cont.)

AC Operating Characteristics ,  $V_{DD} = 5V$  ,  $T_A = 25^\circ C$  ,  $R_L = 4\Omega$  (unless otherwise noted)

Symbol	Parameter	Test Condition	APA2020A			Unit
			Min.	Typ.	Max.	
PSRR	Power supply ripple rejection	f =100 Hz		80		dB
	Mute attenuation			85		dB
	Channel-to-channel output separation			85		dB
	Line/ $\overline{HP}$ input separation			75		dB
	BTL attenuation in SE mode			80		dB
ZI	Input impedance			2		M $\Omega$
	Signal-to-noise ratio	Po = 500 mW , BTL		90		dB
Vn	Output noise voltage			80		$\mu V$ (rms)

Notes 1 : Output power is measured at the output terminals of the IC at 1 KHz.

AC Operating Characteristics ,  $V_{DD} = 3.3V$  ,  $T_A = 25^\circ C$  ,  $R_L = 4\Omega$  (unless otherwise noted)

Symbol	Parameter	Test Condition	APA2020A			Unit
			Min.	Typ.	Max.	
P(out)	Output power (each channel ) see Note 2	THD = 10% , BTL , $R_L=4\Omega$		1		W
		$R_L=8\Omega$		0.6		
		THD = 1% , BTL , $R_L=4\Omega$		0.8		mW
		$R_L=8\Omega$		0.5		
		THD = 10% , SE , $R_L=4\Omega$		290		
$R_L=8\Omega$		180				
THD = 1% , SE , $R_L=4\Omega$		230		mW		
$R_L=8\Omega$		140				
THD = 0.5% , SE , $R_L=32\Omega$		43				
THD + N	Total harmonic distortion plus noise	$P_o = 1.6W$ , BTL , $R_L=4\Omega$		270		m%
		$P_o = 1W$ , BTL , $R_L=8\Omega$		150		
		$P_o = 78mW$ , SE , $R_L=32\Omega$		20		
		$V_1 = 1V$ , $R_L=4\Omega$ , $G = 1$		10		
$B_{OM}$	Maximum output power bandwidth	$G = 10$ , THD < 1%		>20		KHz
	Phase margin	$R_L = 4\Omega$ , BTL		92		°
		$R_L = 4\Omega$ , Open Load		70		
		$R_L = 4\Omega$ , SE		57		

## Electrical Characteristics (Cont.)

AC Operating Characteristics,  $V_{DD} = 3.3V$ ,  $T_A = 25^\circ C$ ,  $R_L = 4\Omega$  (unless otherwise noted)

Symbol	Parameter	Test Condition	APA2020A			Unit
			Min.	Typ.	Max.	
PSRR	Power supply ripple rejection	f = 100 Hz		70		dB
	Mute attenuation			85		dB
	Channel-to-channel output separation	f = 1 KHz		85		dB
	Line/ $\overline{HP}$ input separation			75		dB
	BTL attenuation in SE mode			80		dB
ZI	Input impedance			2		M $\Omega$
	Signal-to-noise ratio	Po = 500 mW, BTL		90		dB
Vn	Output noise voltage			50		$\mu V$ (rms)

Notes 2 : Output power is measured at the output terminals of the IC at 1 KHz.

DC Electrical Characteristic,  $T_A = 25^\circ C$

Symbol	Parameter	Test Conditions		APA2020A		Unit
				Typ.	Max.	
$I_{DD}$	Supply Current	$V_{DD} = 5V$	Stereo BTL	8	11	mA
			Stereo SE	4	6.5	mA
		$V_{DD} = 3.3V$	Stereo BTL	7	9	mA
			Stereo SE	3.5	5.6	mA
$V_{O(DIFF)}$	DC Differential Output Voltage	$V_{DD} = 5V$ , Gain = 2, see Note3		5	25	mV
$I_{DD(MUTE)}$	Supply Current in Mute Mode	$V_{DD} = 5V$		8	11	mA
$I_{SD}$	$I_{DD}$ in Shutdown	$V_{DD} = 5V$		0.5	5	$\mu A$

Note 3 : at  $3V < V_{DD} < 5V$ , the DC output voltage is approximately  $V_{DD} / 2$ .

## Pin Description

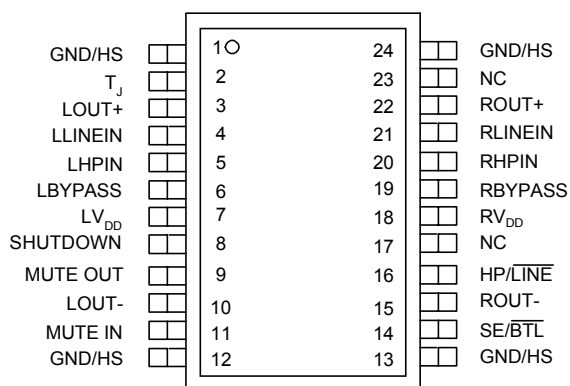

Top View

For SOP and TSSOP-P

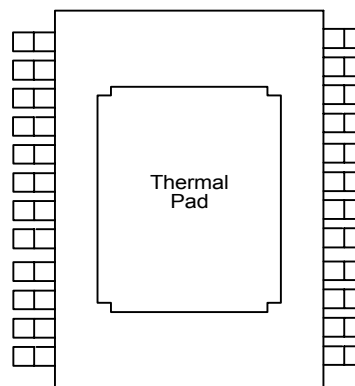

Bottom View

For TSSOP-P Only

Pin		I/O	Description
Name	No		
GND/HS	1,12, 13,24		Ground connection for circuitry, directly connected to thermal pad (only in TSSOP-P package).
T <sub>J</sub>	2	O	Shutdown mode control signal input, sources a current proportional to the junction temperature. This pin should be left unconnected during normal operation. For more information, see the junction temperature measurement section of this document.
LOUT +	3	O	Left channel + output in BTL mode, + output in SE mode.
L LINE IN	4	I	Left channel line input, selected when HP/ $\overline{\text{LINE}}$ pin (16) is held low.
LHP IN	5	I	Left channel headphone input, selected when HP/ $\overline{\text{LINE}}$ pin (16) is held high.
LBYPASS	6		Connect to voltage divider for left channel internal mid-supply bias.
LV <sub>DD</sub>	7	I	Supply voltage input for left channel and for primary bias circuits.
SHUTDOWN	8	I	Shutdown mode control signal input, places entire IC in shutdown mode when held high, I <sub>DD</sub> = 0.5 $\mu$ A.
MUTE OUT	9	O	Follows MUTE in pin (11), provides buffered output.
LOUT -	10	O	Left channel - output in BTL mode, high-impedance state in SE mode.
MUTE IN	11	I	Mute control signal input, hold low for normal operation, hold high to mute.
SE/ $\overline{\text{BTL}}$	14	I	Mode control signal input, hold low for BTL mode, hold high for SE mode.
ROUT-	15	O	Right channel - output in BTL mode, high impedance state in SE mode.
HP/ $\overline{\text{LINE}}$	16	I	MUX control input, hold high to select headphone inputs (5,20), hold low to select line inputs (4,21).

Pin Description (Cont.)

Pin		I/O	Description
Name	No		
NC	17,23		No internal connection.
$R_{V_{DD}}$	18	I	Supply voltage input for right channel.
RBYPASS	19		Connect to voltage divider for right channel internal mild-supply bias.
RHP IN	20	I	Right channel headphone input, selected when $\overline{HP/LINE}$ pin (16) is held high.
RLINE IN	21	I	Right channel line input, selected when $\overline{HP/LINE}$ pin (16) is held low.
ROUT+	22	O	Right channel + output in BTL mode, + output in SE mode.

Test Information

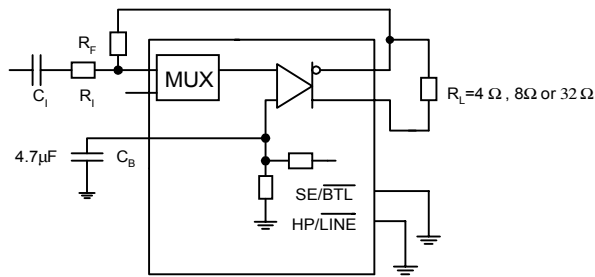

Figure 2. BTL Test Circuit

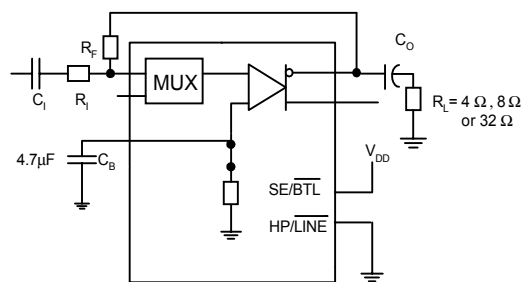
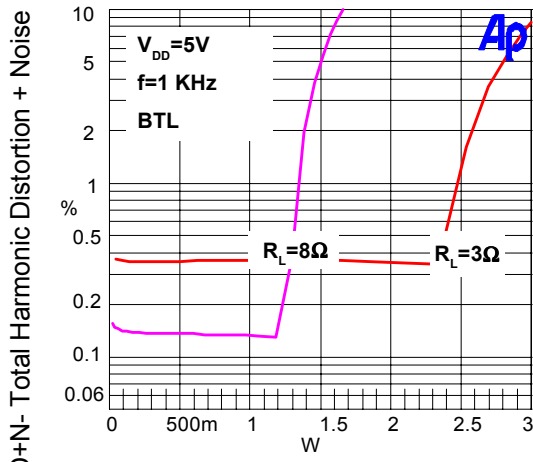
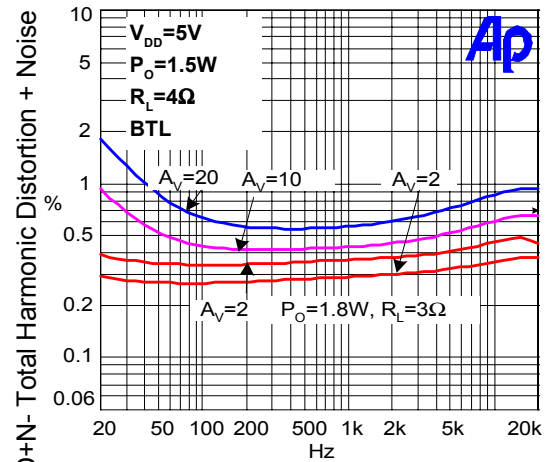

Figure 3. SE Test Circuit

Typical Characteristics



Po - Output Power  
Figure 4



f - Frequency  
Figure 5

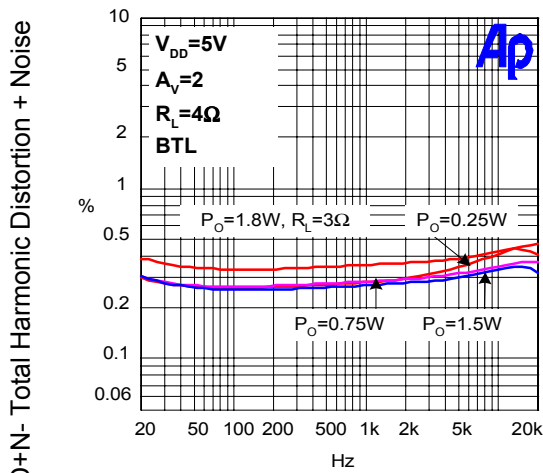

f - Frequency  
Figure 6

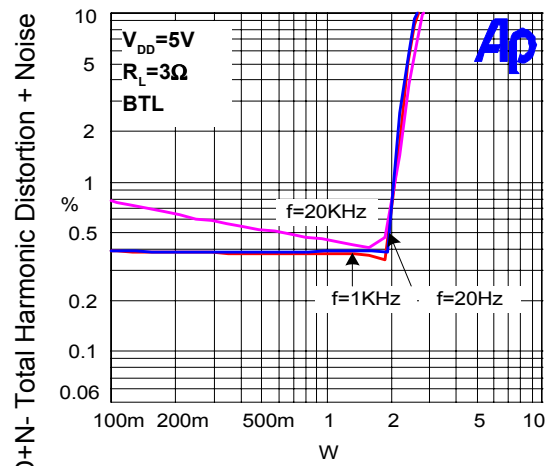

Po - Output Power  
Figure 7



Typical Characteristics (Cont.)

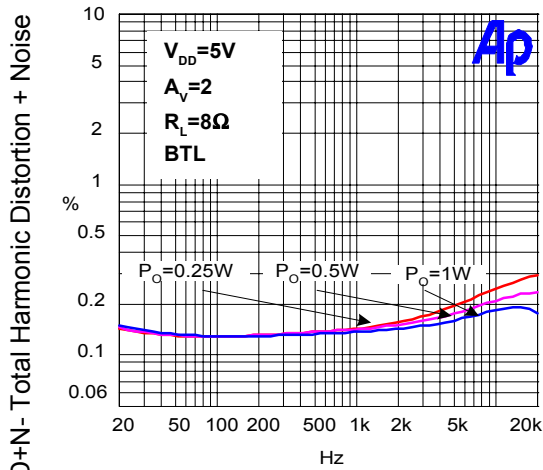

f - Frequency- Hz  
Figure 8

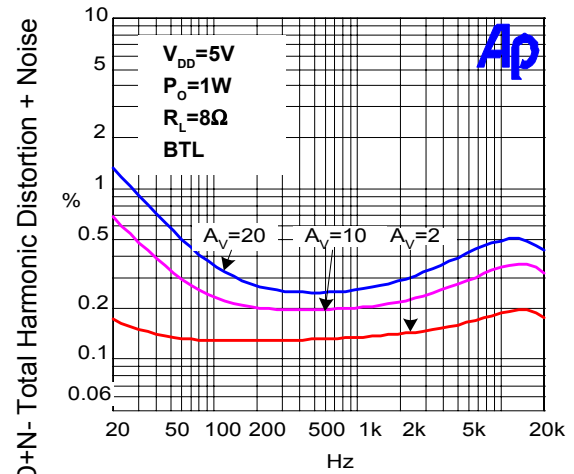

f - Frequency- Hz  
Figure 9

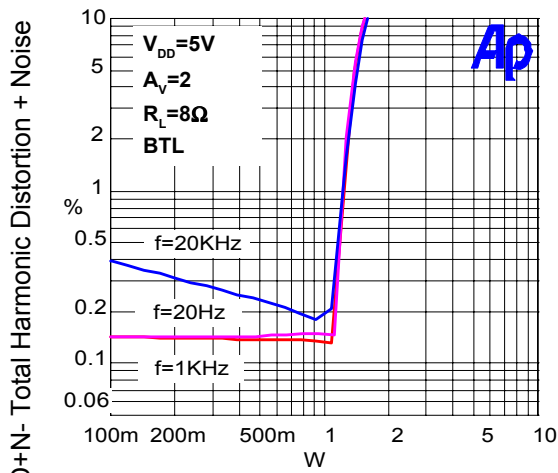

PO - Output Power  
Figure 10

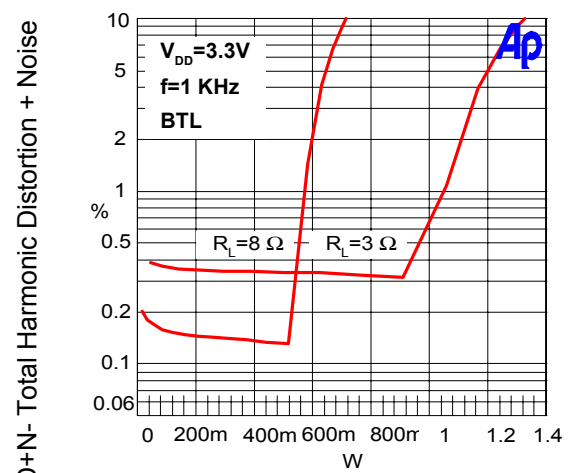

PO - Output Power  
Figure 11

Typical Characteristics (Cont.)

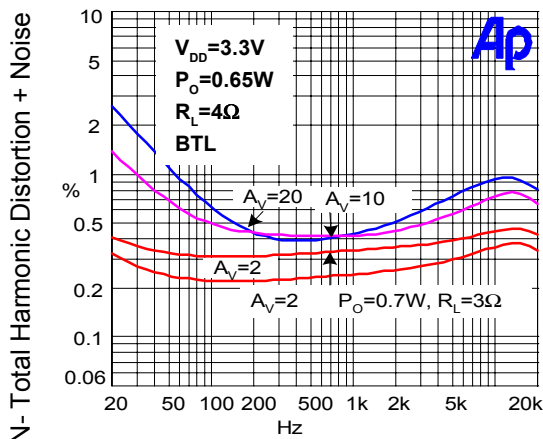

f - Frequency  
Figure 12

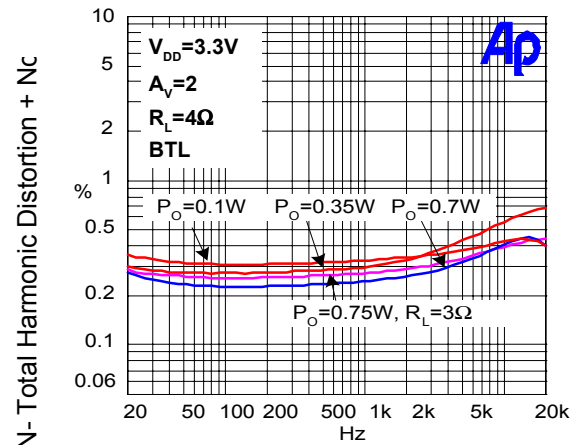

f - Frequency  
Figure 13

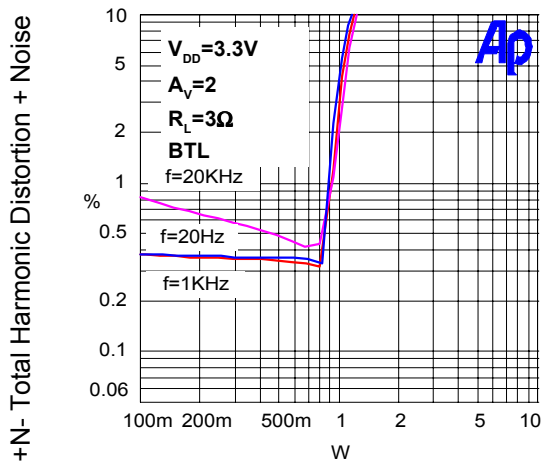

Po - Output Power  
Figure 14

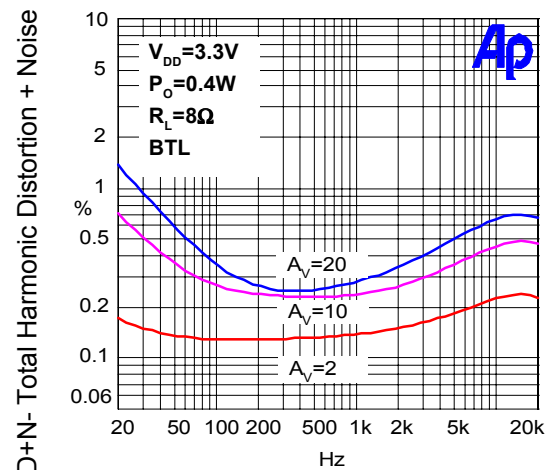

f - Frequency  
Figure 15

Typical Characteristics (Cont.)

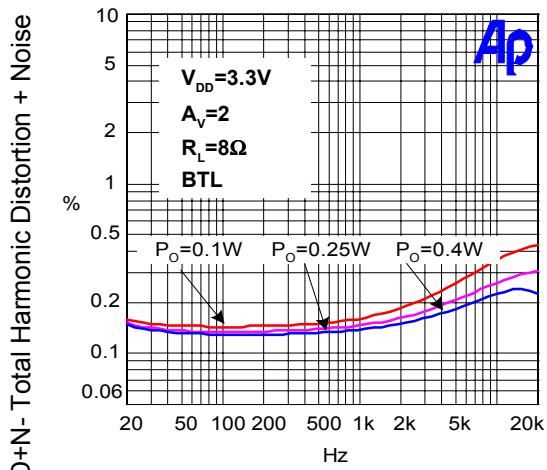

f - Frequency  
Figure 16

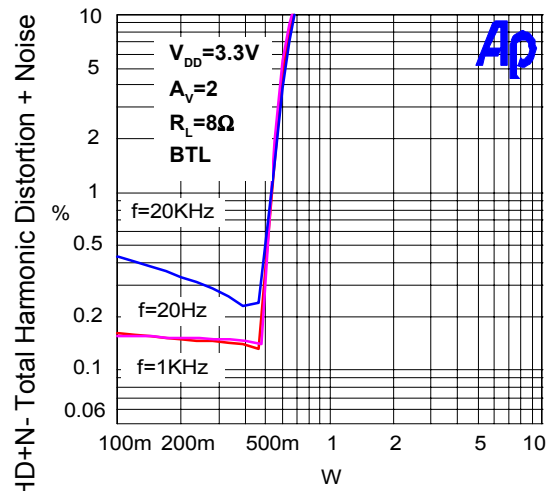

Po - Output Power  
Figure 17

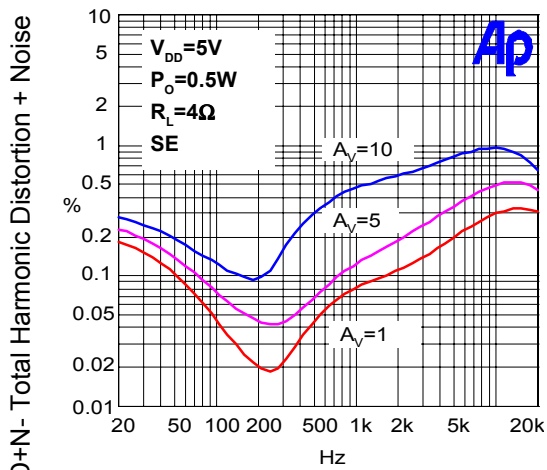

f - Frequency  
Figure 18

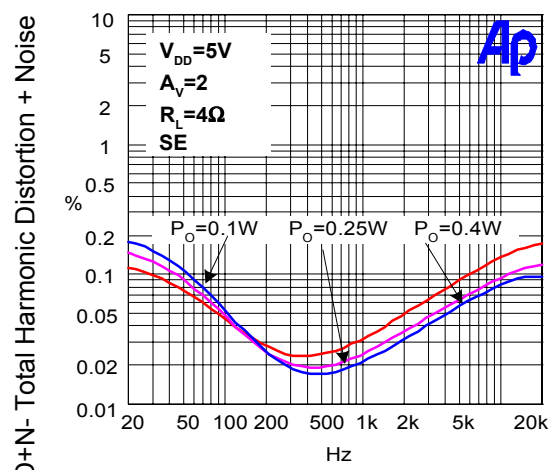

f - Frequency  
Figure 19

Typical Characteristics (Cont.)

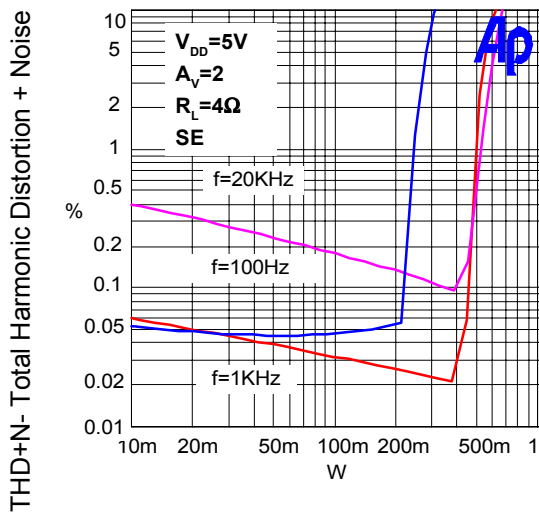

Po - Output Power  
Figure 20

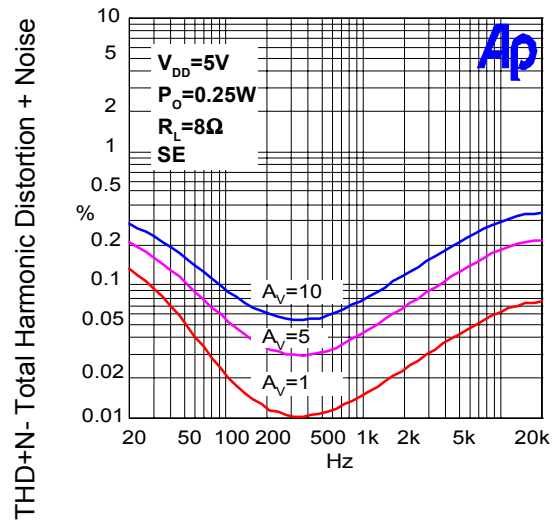

f - Frequency- Hz  
Figure 21

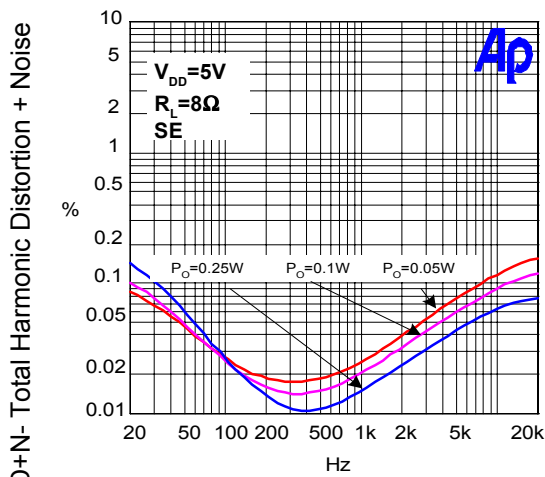

f - Frequency- Hz  
Figure 22

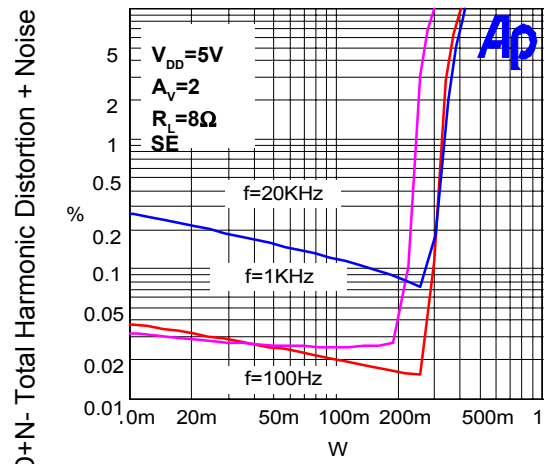

Po - Output Power  
Figure 23

Typical Characteristics (Cont.)

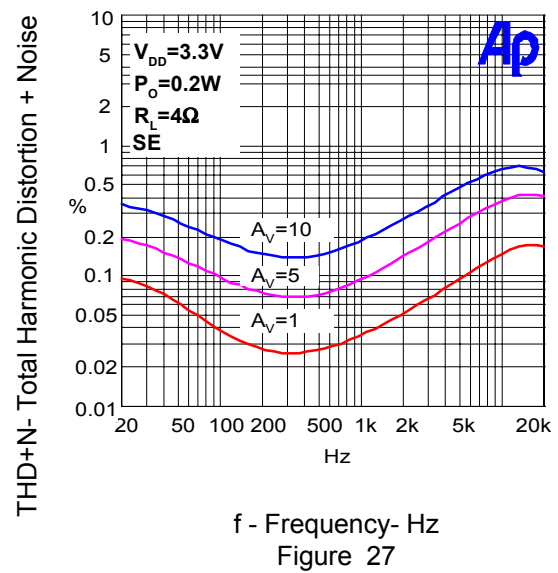
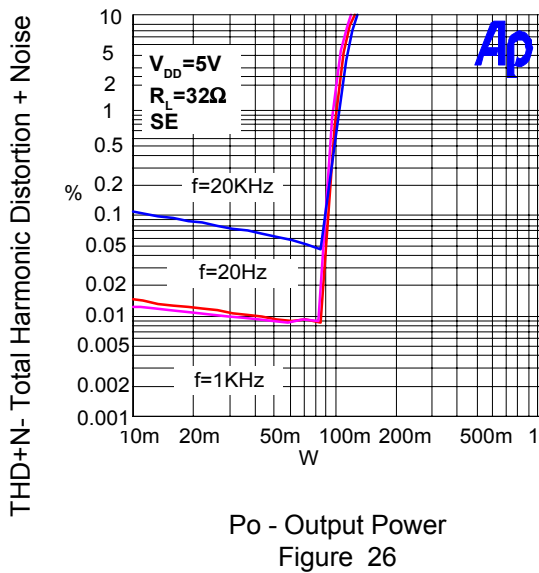
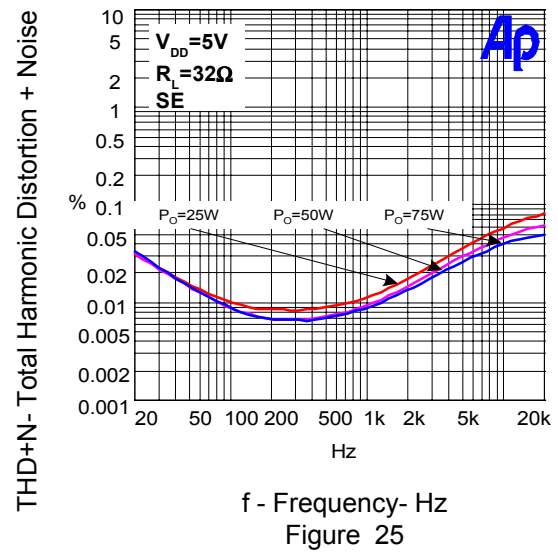
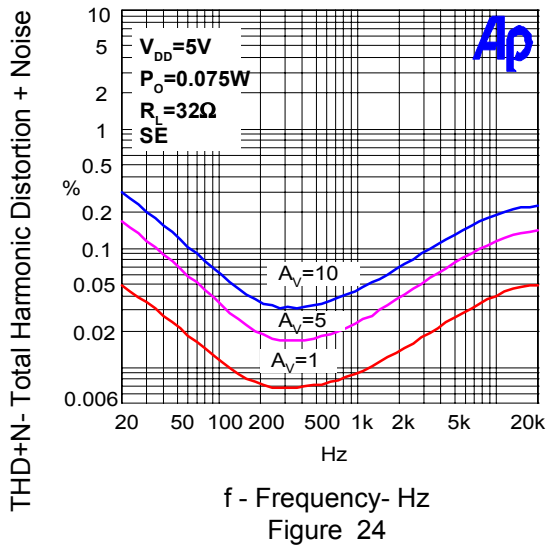

Typical Characteristics (Cont.)

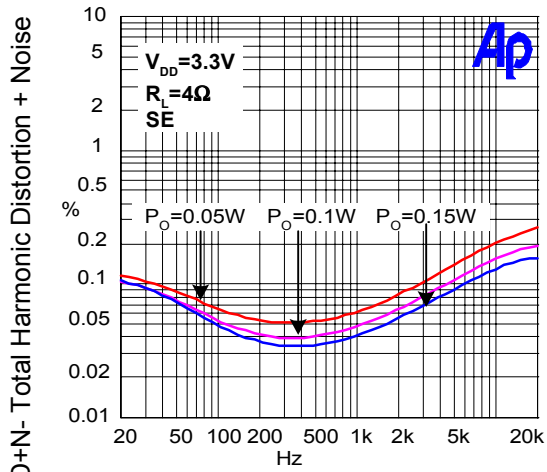

f - Frequency  
Figure 28

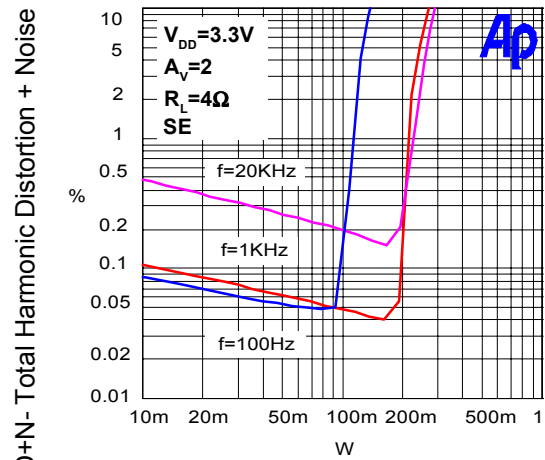

P<sub>o</sub> - Output Power  
Figure 29

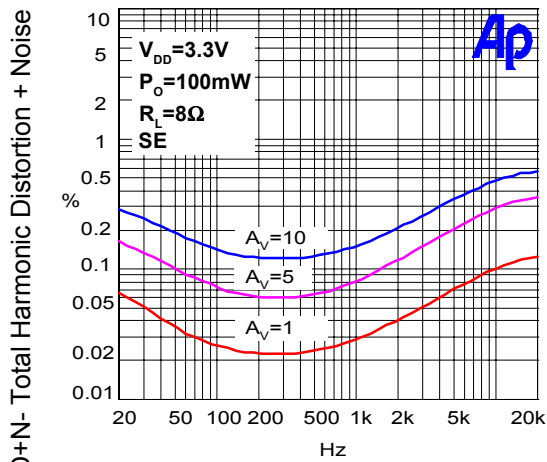

f - Frequency  
Figure 30

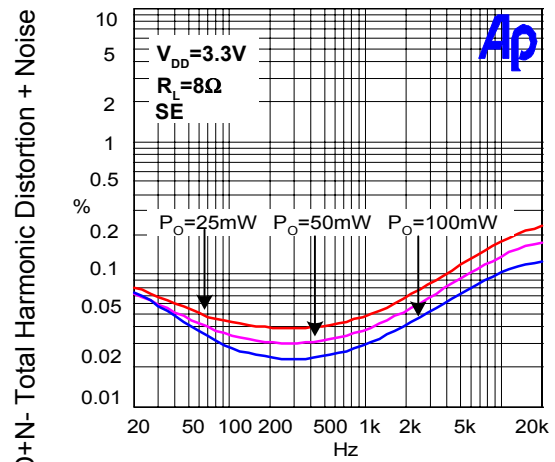

f - Frequency  
Figure 31

Typical Characteristics (Cont.)

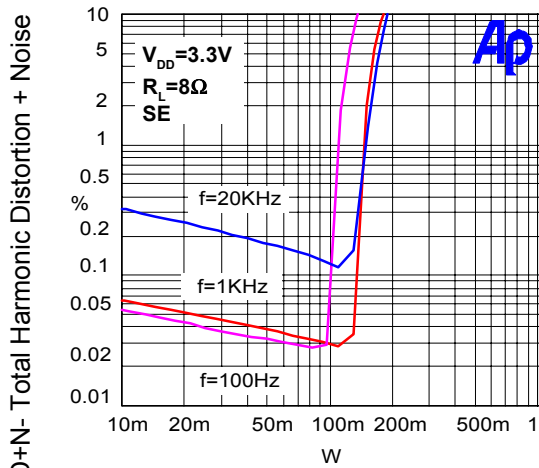

Po - Output Power  
Figure 32

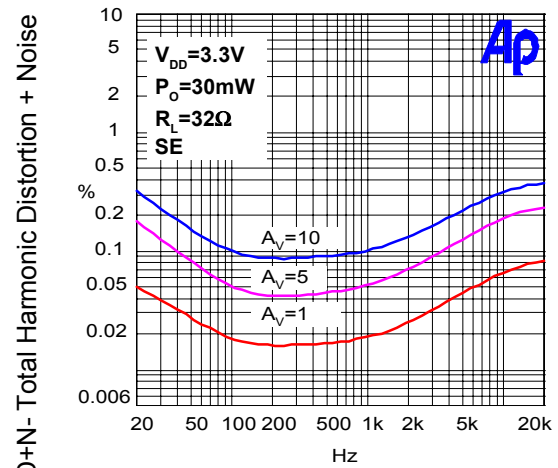

f - Frequency  
Figure 33

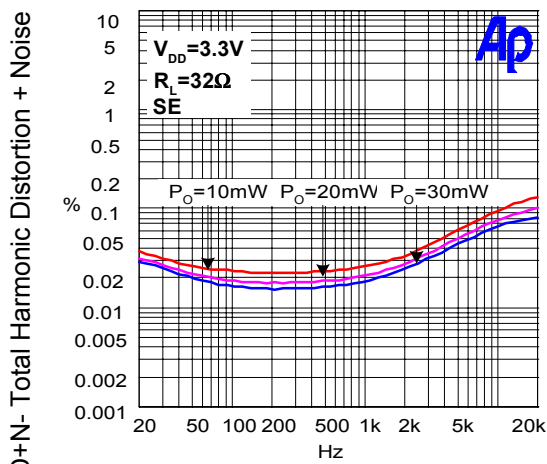

f - Frequency  
Figure 34

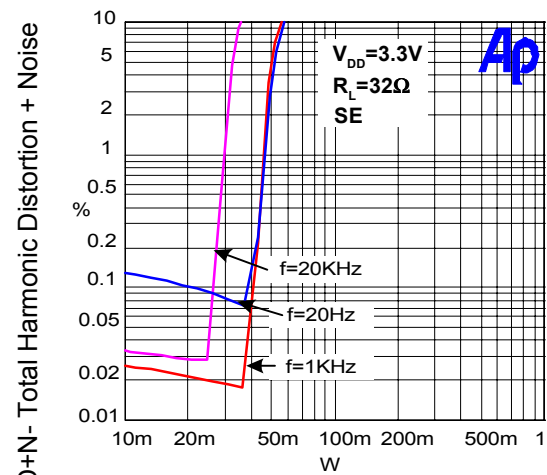

Po - Output Power  
Figure 35

Typical Characteristics (Cont.)

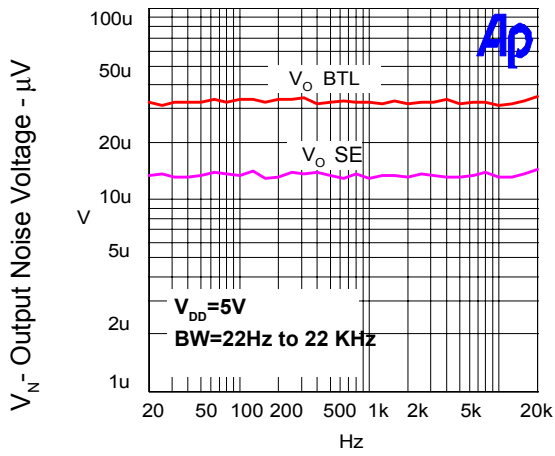

f - Frequency  
Figure 36

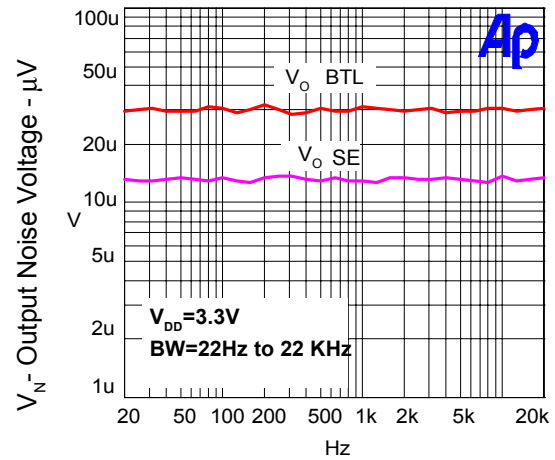

f - Frequency  
Figure 37

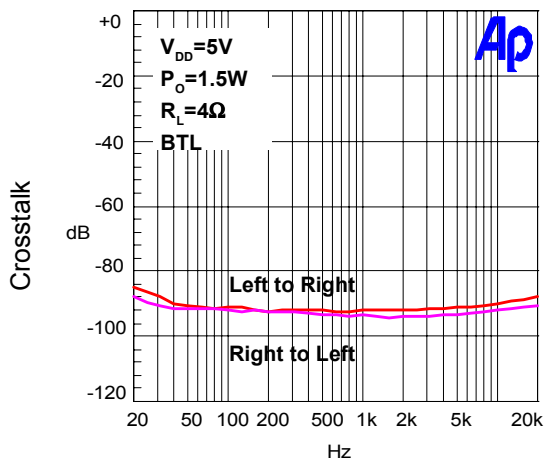

f - Frequency  
Figure 38

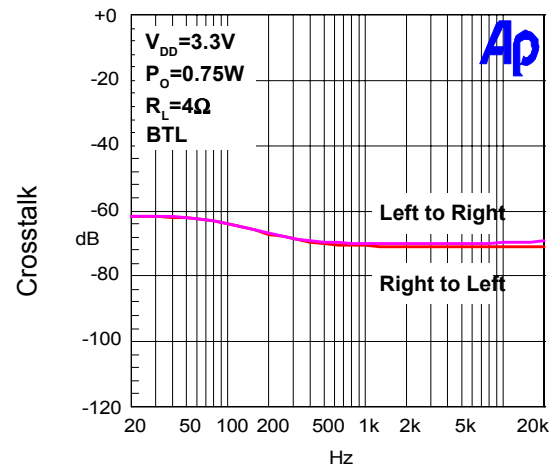

f - Frequency  
Figure 39



Typical Characteristics (Cont.)

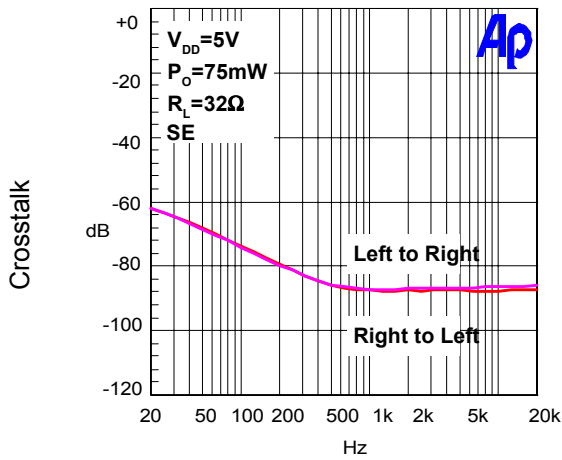

f - Frequency  
Figure 40

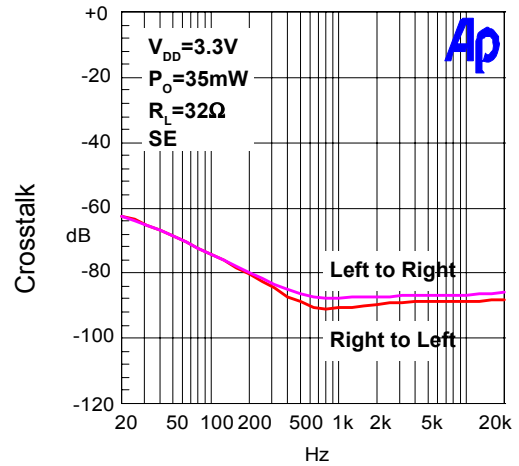

f - Frequency  
Figure 41

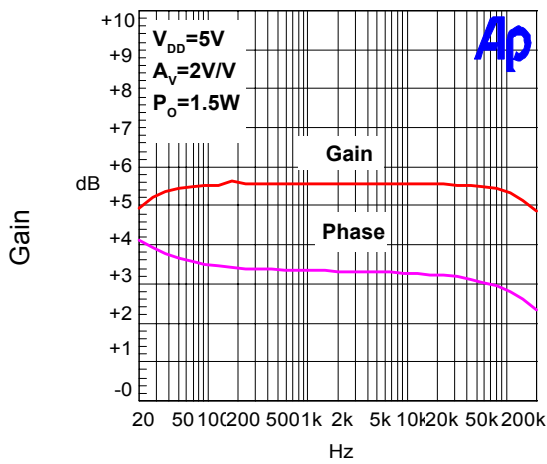

f - Frequency  
Figure 42

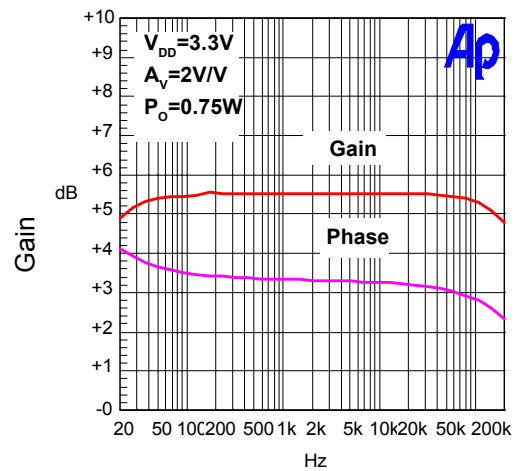

f - Frequency  
Figure 43

Typical Characteristics (Cont.)

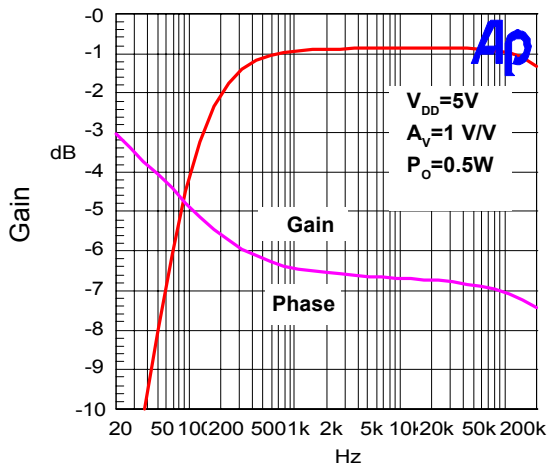

f- Frequency  
Figure 44

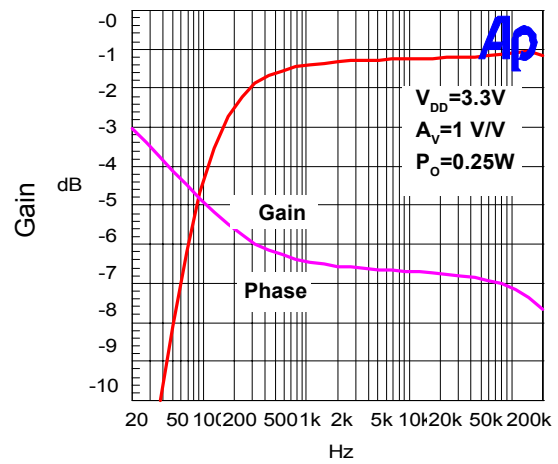

f- Frequency  
Figure 45

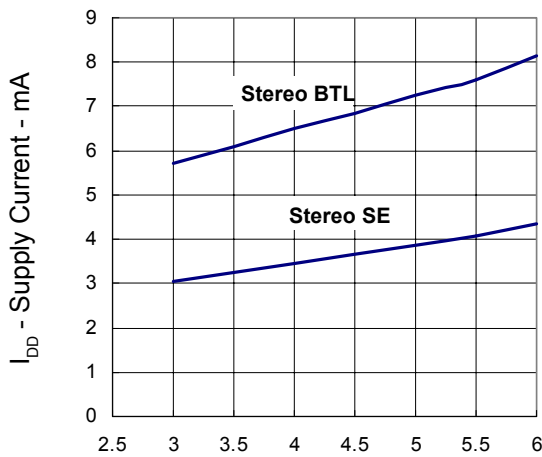

$V_{DD}$  - Supply Voltage - V  
Figure 46

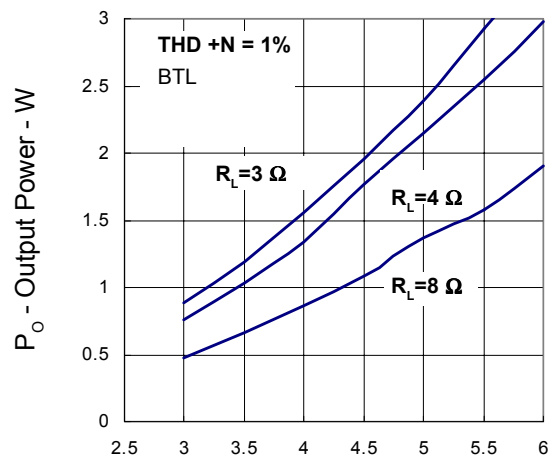

$V_{DD}$  - Supply Voltage - V  
Figure 47

Typical Characteristics (Cont.)

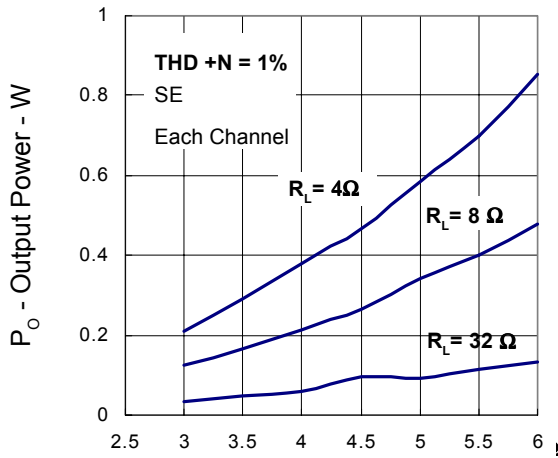

Figure 48

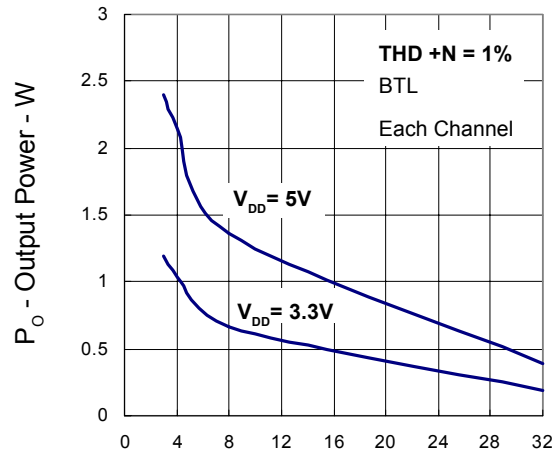

Figure 49

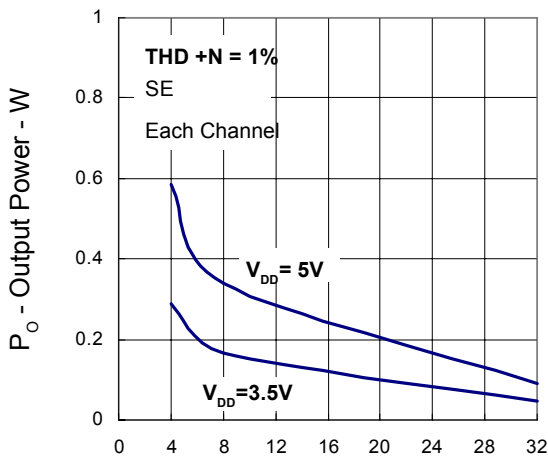

Figure 50

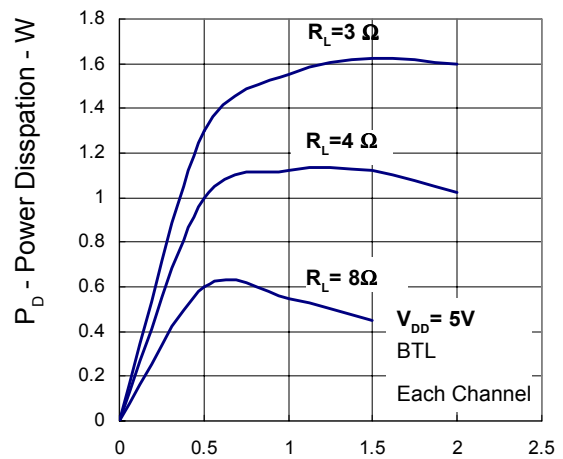
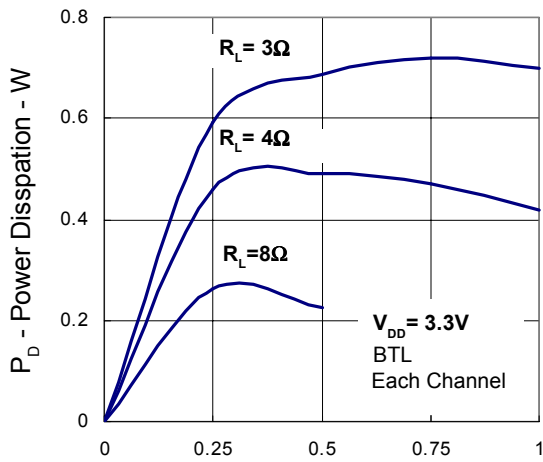
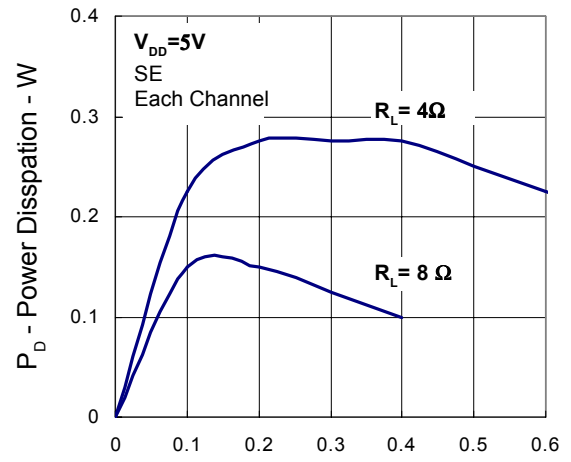

Figure 51

Typical Characteristics (Cont.)



$P_O$  - Output Power - W  
Figure 52



$P_O$  - Output Power - W  
Figure 53

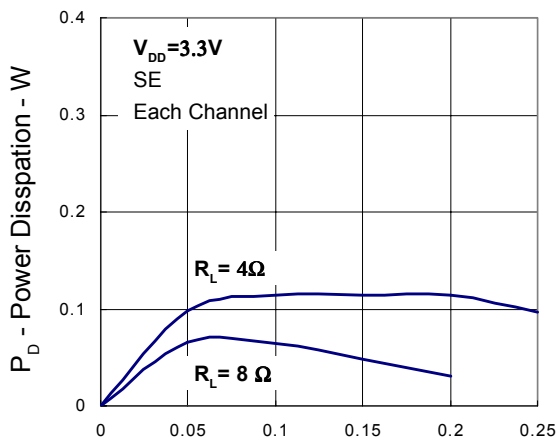

$P_O$  - Output Power - W  
Figure 54

## Packaging Information

SO – 300mil ( Reference JEDEC Registration MS-013)

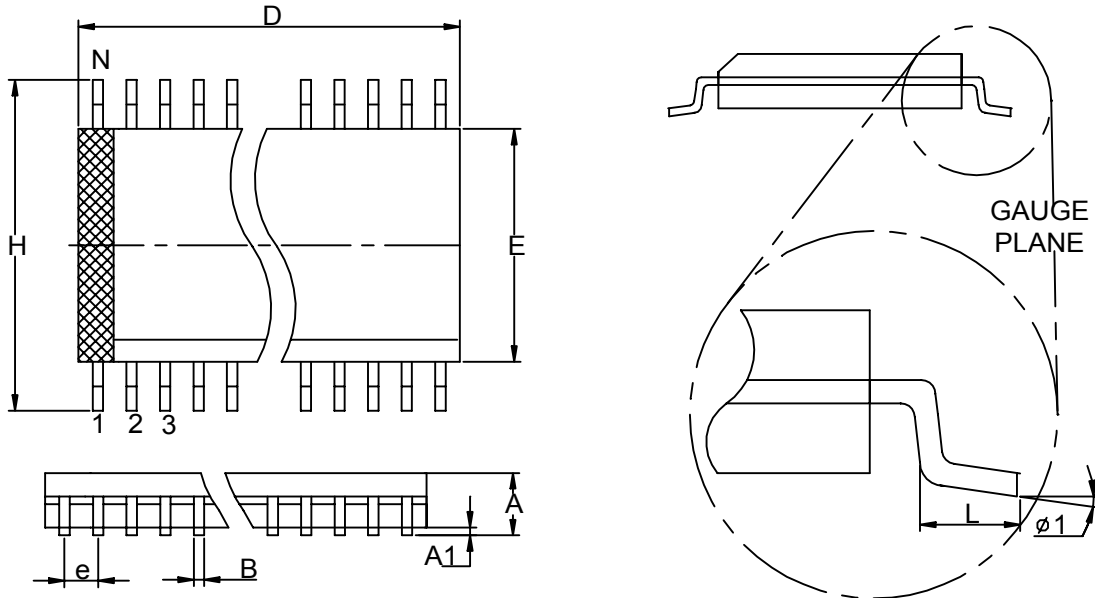

Dim	Millimeters		Variations- D			Dim	Inches		Variations- D		
	Min.	Max.	Variations	Min.	Max.		Min.	Max.	Variations	Min.	Max.
A	2.35	2.65	SO-16	10.10	10.50	A	0.093	0.1043	SO-16	0.398	0.413
A1	0.10	0.30	SO-18	11.35	11.76	A1	0.004	0.0120	SO-18	0.447	0.463
B	0.33	0.51	SO-20	12.60	13	B	0.013	0.020	SO-20	0.496	0.512
D	See variations		SO-24	15.20	15.60	D	See variations		SO-24	0.599	0.614
E	7.40	7.60	SO-28	17.70	18.11	E	0.2914	0.2992	SO-28	0.697	0.713
e	1.27BSC		SO-14	8.80	9.20	e	0.050BSC		SO-14	0.347	0.362
H	10	10.65				H	0.394	0.419			
L	0.40	1.27				L	0.016	0.050			
N	See variations					N	See variations				
phi 1	0°	8°				phi 1	0°	8°			

## Packaging Information

TSSOP/ TSSOP-P ( Reference JEDEC Registration MO-153)

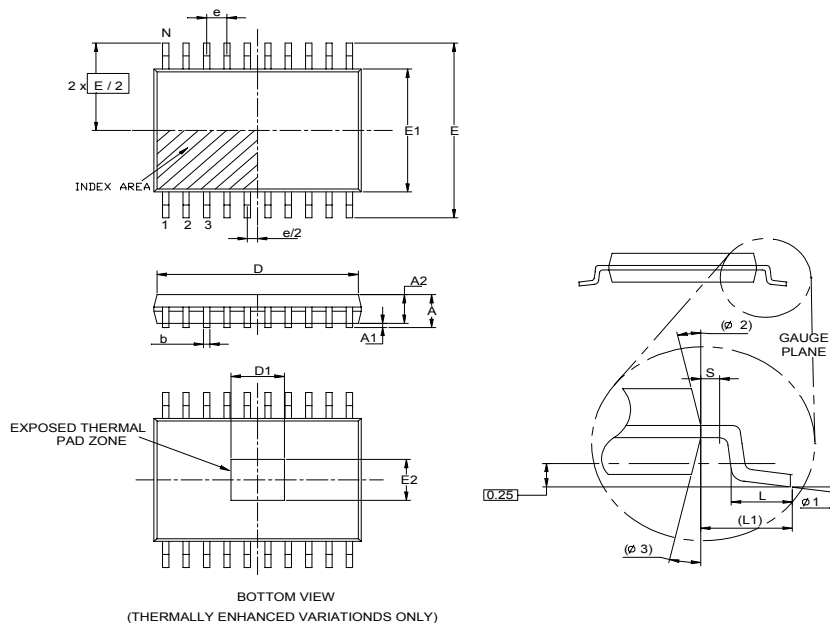

Dim	Millimeters		Inches	
	Min.	Max.	Min.	Max.
A		1.2		0.047
A1	0.00	0.15	0.000	0.006
A2	0.80	1.05	0.031	0.041
D	6.4 (N=20PIN)	6.6 (N=20PIN)	0.252 (N=20PIN)	0.260 (N=20PIN)
	7.7 (N=24PIN)	7.9 (N=24PIN)	0.303 (N=24PIN)	0.311 (N=24PIN)
	9.6 (N=28PIN)	9.8 (N=28PIN)	0.378 (N=28PIN)	0.386 (N=28PIN)
D1	4.2 BSC (N=20PIN)		0.165 BSC (N=20PIN)	
	4.7 BSC (N=24PIN)		0.188 BSC (N=24PIN)	
	3.8 BSC (N=28PIN)		0.150 BSC (N=28PIN)	
e	0.65 BSC		0.026 BSC	
E	6.40 BSC		0.252 BSC	
E1	4.30	4.50	0.169	0.177
E2	3.0 BSC (N=20PIN)		0.118 BSC (N=20PIN)	
	3.2 BSC (N=24PIN)		0.127 BSC (N=24PIN)	
	2.8 BSC (N=28PIN)		0.110 BSC (N=28PIN)	
L	0.45	0.75	0.018	0.030
L1	1.0 REF		0.039 REF	
R	0.09		0.004	
R1	0.09		0.004	
S	0.2		0.008	
$\phi 1$	0°	8°	0°	8°
$\phi 2$	12° REF		12° REF	
$\phi 3$	12° REF		12° REF	

## Physical Specifications

Terminal Material	Solder-Plated Copper (Solder Material : 90/10 or 63/37 SnPb)
Lead Solderability	Meets EIA Specification RSI86-91, ANSI/J-STD-002 Category 3.

## Reflow Condition (IR/Convection or VPR Reflow)

Reference JEDEC Standard J-STD-020A APRIL 1999

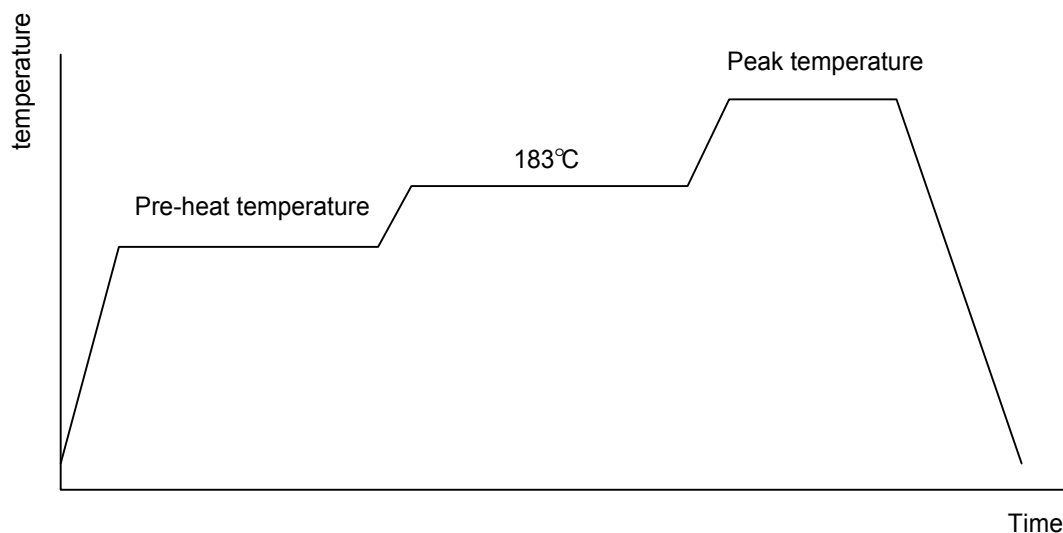

## Classification Reflow Profiles

	Convection or IR/ Convection	VPR
Average ramp-up rate(183°C to Peak)	3°C/second max.	10 °C /second max.
Preheat temperature 125 ± 25°C)	120 seconds max	
Temperature maintained above 183°C	60 – 150 seconds	
Time within 5°C of actual peak temperature	10 –20 seconds	60 seconds
Peak temperature range	220 +5/-0°C or 235 +5/-0°C	215-219°C or 235 +5/-0°C
Ramp-down rate	6 °C /second max.	10 °C /second max.
Time 25°C to peak temperature	6 minutes max.	

## Package Reflow Conditions

pkg. thickness ≥ 2.5mm and all bgas	pkg. thickness < 2.5mm and pkg. volume ≥ 350 mm <sup>3</sup>	pkg. thickness < 2.5mm and pkg. volume < 350mm <sup>3</sup>
Convection 220 +5/-0 °C		Convection 235 +5/-0 °C
VPR 215-219 °C		VPR 235 +5/-0 °C
IR/Convection 220 +5/-0 °C		IR/Convection 235 +5/-0 °C

## Reliability test program

Test item	Method	Description
SOLDERABILITY	MIL-STD-883D-2003	245°C , 5 SEC
HOLT	MIL-STD-883D-1005.7	1000 Hrs Bias @ 125 °C
PCT	JESD-22-B, A102	168 Hrs, 100 % RH , 121°C
TST	MIL-STD-883D-1011.9	-65°C ~ 150°C, 200 Cycles
ESD	MIL-STD-883D-3015.7	VHBM > 2KV, VMM > 200V
Latch-Up	JESD 78	10ms , I <sub>lr</sub> > 100mA

## Carrier Tape & Reel Dimensions

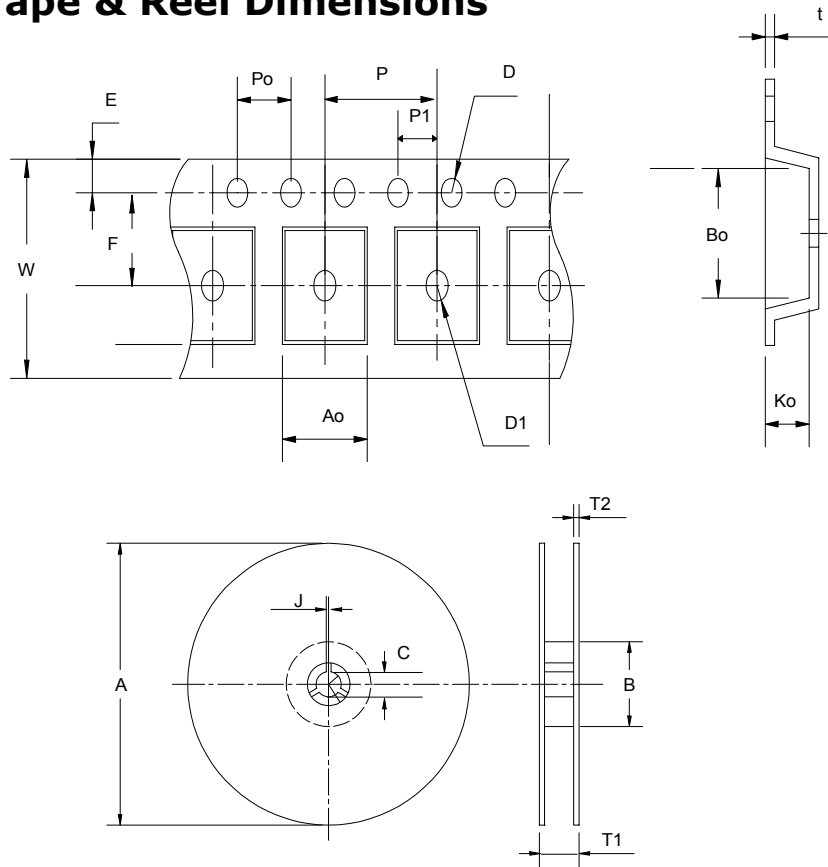

Application	A	B	C	J	T1	T2	W	P	E
SOP- 24	330±1	62 ±1.5	12.75 ± 0.15	2 ± 0.6	24.4 ± 0.2	2 ± 0.2	24 ± 0.3	12 ± 0.1	1.75 ± 0.1
	F	D	D1	Po	P1	Ao	Bo	Ko	t
	11.5 ± 0.1	1.55 ± 0.1	1.5 ± 0.25	4.0 ± 0.1	2.0 ± 0.1	10.9 ± 0.1	15.9 ± 0.1	3.1 ± 0.1	0.35 ± 0.05

(mm)



## Cover Tape Dimensions

Application	Carrier Width	Cover Tape Width	Devices Per Reel
SOP- 16 / 20 / 24 / 28	24	21.3	1000

## Customer Service

### Anpec Electronics Corp.

Head Office :

5F, No. 2 Li-Hsin Road, SBIP,

Hsin-Chu, Taiwan, R.O.C.

Tel : 886-3-5642000

Fax : 886-3-5642050

Taipei Branch :

7F, No. 137, Lane 235, Pac Chiao Rd.,

Hsin Tien City, Taipei Hsien, Taiwan, R. O. C.

Tel : 886-2-89191368

Fax : 886-2-89191369