

Features

- Complete 3.0 GHz Single Chip System
- Optimised for Low Phase Noise, with Comparison Frequencies up to 4 MHz
- No RF Prescaler
- Selectable Reference Division Ratio
- Selectable Reference/Comparison Frequency Output
- Selectable Charge Pump Current with 10:1 Ratio
- Four Selectable I²C Addresses
- I²C Fast Mode Compliant with 3.3V and 5V Logic Levels
- Four Switching Ports
- Functional Replacement for SP5659 (except ADC)
- Pin Compatible with SP5655
- Power Consumption 110mW with V_{CC} = 5.5V, all Ports off
- ESD Protection 2kV min., MIL-STD-883B Method 3015 Cat.1 (Normal ESD handling procedures should be observed)

Applications

- Digital Satellite and Cable Tuning Systems
- Communications Systems

The SP5769 is a single chip frequency synthesiser designed for tuning systems up to 3GHz. The RF preamplifier interfaces direct with the RF programmable divider, which is of MN+A construction so giving a step

Ordering Information

- SP5769A/KG/MP1S (Tubes)
- SP5769A/KG/MP1T (Tape and Reel)
- SP5769A/KG/QP1S (Tubes)
- SP5769A/KG/QP1T (Tape and Reel)

size equal to the loop comparison frequency and no prescaler phase noise degradation over the full RF operating range. The comparison frequency is obtained either from an on-chip crystal controlled oscillator, or from an external source. The oscillator frequency, f_{REF}, or phase comparator frequency, f_{COMP}, can be switched to the REF/COMP output providing a reference for a second frequency synthesiser. The synthesiser is controlled via an I²C bus

Absolute Maximum Ratings

All voltages are referred to V _{EE} = 0V	
Supply voltage, V _{CC}	0.3V to +7V
RF differential input voltage	2.5Vp-p
All I/O port DC offsets	-0.3 to V _{CC} +0.3V
SDA and SCL DC offset	-0.3 to 6V
Storage temperature	-55°C to +125°C
Junction temperature	+150°C
MP16 thermal resistance	
Chip to ambient, θ _{JA}	80°C/W
Chip to case, θ _{JC}	20°C/W

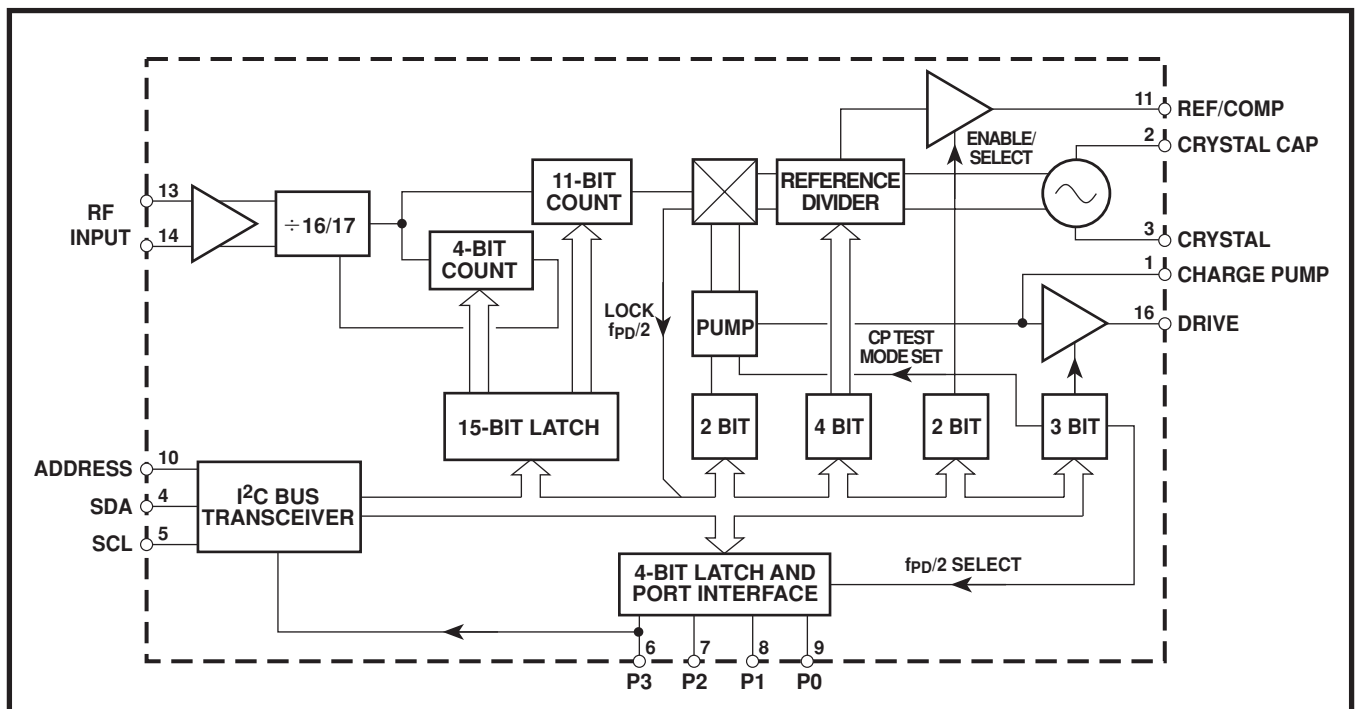

Figure 1 SP5769 block diagram

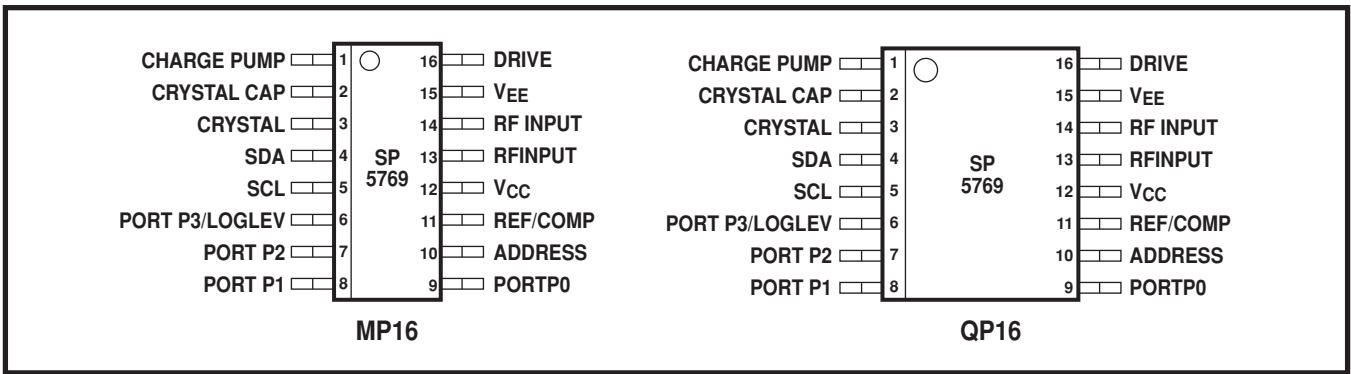

Figure 2 Pin connections - top view

Electrical Characteristics

Test conditions (unless otherwise stated): $T_{AMB} = -40^{\circ}\text{C}$ to $+80^{\circ}\text{C}$, $V_{CC} = 4.5\text{V}$ to 5.5V . These characteristics are guaranteed by either production test or design. They apply within the specified ambient temperature and supply voltage ranges unless otherwise stated.

Characteristic	Pin	Value			Units	Conditions
		Min.	Typ.	Max.		
Supply current	12		20	25	mA	
RF input	13,14					
Input voltage		100		300	mVrms	100MHz to 200MHz
Input impedance		40		300	mVrms	200MHz to 3GHz See Figure 4
SDA, SCL	4,5					
Input high voltage		3		5.5	V	5V I ² C logic selected
Input low voltage		2.3		5.5	V	3.3V I ² C logic selected
Input high current		0		1.5	V	5V I ² C logic selected
Input low current		0		1	V	3.3V I ² C logic selected
Leakage current				10	μA	Input voltage = V_{CC}
Input hysteresis				-10	μA	Input voltage = V_{EE}
SDA output voltage	4	0.4		10	μA	$V_{CC} = V_{EE}$
SCL clock rate	5			0.4	V	$I_{SINK} = 3\text{mA}$
				0.6	V	$I_{SINK} = 6\text{mA}$
				400	kHz	
Charge pump						
Output current	1					See Table 6, $V_{PIN1} = 2\text{V}$
Output leakage	1		±3	±10	nA	$V_{PIN1} = 2\text{V}$, $V_{CC} = +5.0\text{V}$, $T_{AMB} = 25^{\circ}\text{C}$
Drive output current	16	0.5			mA	$V_{PIN16} = 0.7\text{V}$
Crystal frequency	2,3	2		20	MHz	See Figure 5 for application
External reference	3					
Input frequency		2		20	MHz	Sinewave coupled via 10nF blocking capacitor
Drive level		0.2		0.5	Vp-p	Sinewave coupled via 10nF blocking capacitor
Buffered REF/COMP	11					AC coupled, see Note 2
Output amplitude			0.35		Vp-p	0.0625 to 20MHz
Output impedance			250		Ω	Enabled by bit RE = 1
Comparison frequency				4	MHz	
Equivalent phase noise at phase detector		-148			dBc/Hz	SSB, within loop bandwidth, all comparison frequencies
RF division ratio		240		32767		
Reference division ratio						See Table 1

cont...

Electrical Characteristics (continued)

Characteristic	Pin	Value			Units	Conditions
		Min.	Typ.	Max.		
Output Ports P3 - P0 Sink current Leakage current	6-9	2		10	mA μ A	$V_{PORT} = 0.7V$ $V_{PORT} = V_{CC}$ See Note 1
Address select Input high current Input low current	10			1 -0.5	mA μ A	See Table 3 $V_{IN} = V_{CC}$ $V_{IN} = V_{EE}$
Logic level select Input high level Input low level Input current	6	3 0		1.5 10	V V μ A	See Note 3 5V I ² C logic level selected or open circuit 3.3V I ² C logic level selected $V_{IN} = V_{EE}$ to V_{CC}

NOTES

- Output ports high impedance on power-up, with SDA and SCL at logic '0'.
- If the REF/COMP output is not used, the output should be left open circuit or connected to V_{CC} and disabled by setting RE = '0'.
- Bi-directional port. When used as an output, the input logic state is ignored. When used as an input, the port should be switched into high impedance (off) state.

Functional Description

The SP5769 contains all the elements necessary, with the exception of a frequency reference, loop filter and external high voltage transistor, to control a varactor tuned local oscillator, so forming a complete PLL frequency synthesised source. The device allows for operation with a high comparison frequency and is fabricated in high speed logic, which enables the generation of a loop with good phase noise performance.

The RF input signal is fed to an internal preamplifier, which provides gain and reverse isolation from the divider signals. The output of the preamplifier interfaces with the 15-bit fully programmable divider which is of MN+A architecture, where the dual modulus prescaler is $\div 16/17$, the A counter is 4 bits, and the M counter is 11 bits.

The output of the programmable divider is applied to the phase comparator where it is compared in both phase and frequency domains with the comparison frequency. This frequency is derived either from the on-chip crystal controlled oscillator or from an external reference source. In both cases the reference frequency is divided down to the comparison frequency by the reference divider which is programmable into 1 of 16 ratios as detailed in Table 1.

The output of the phase detector feeds a charge pump and loop amplifier section, which when used with an external high voltage transistor and loop filter, integrates the current pulses into the varactor line voltage. The programmable divider output $f_{PD}/2$ can be switched to port P0 by programming the device into test mode. The test modes are described in Table 5.

Programming

The SP5769 is controlled by an I²C data bus and is compatible with both standard and fast mode formats and with I²C data generated from nominal 3.3V and 5V sources. The I²C logic level is selected by the bi-directional port P3/ LOGLEV. 5V logic levels are selected by connecting P3/ LOGLEV to V_{CC} or leaving it open circuit; 3.3V logic levels are set by connecting P3/LOGLEV to ground. If this port is used as an input the P3 data should be programmed to high impedance. If used as an output only 5V logic levels can be used, in which case the logic state imposed by the port on the input is ignored.

Data and clock are fed in on the SDA and SCL lines respectively as defined by I²C bus format. The synthesiser can either accept data (write mode), or send data (read mode). The LSB of the address byte (R/W) sets the device into write mode if it is low, and read mode if it is high. Tables 2 and 3 illustrate the format of the data. The device can be programmed to respond to several addresses, which enables the use of more than one synthesiser in an I²C bus system. Table 4 shows how the address is selected by applying a voltage to the address input. When the device receives a valid address byte, it pulls the SDA line low during the acknowledge period, and during following acknowledge periods after further data bytes are received. When the device is programmed into read mode, the controller accepting the data must be pulled low during all status byte acknowledge periods to read another status byte. If the controller fails to pull the SDA line low during this period, the device generates an internal STOP condition, which inhibits further reading.

R3	R2	R1	R0	Division ratio
0	0	0	0	2
0	0	0	1	4
0	0	1	0	8
0	0	1	1	16
0	1	0	0	32
0	1	0	1	64
0	1	1	0	128
0	1	1	1	256
1	0	0	0	24
1	0	0	1	5
1	0	1	0	10
1	0	1	1	20
1	1	0	0	40
1	1	0	1	80
1	1	1	0	160
1	1	1	1	320

Table 1 Reference division ratios

Write mode

With reference to Table 2, bytes 2 and 3 contain frequency information bits 2^{14} - 2^0 inclusive. Bytes 4 and 5 control the reference divider ratio (see Table 1), charge pump setting (see Table 6), REF/COMP output (see Table 7), output ports and test modes (see Table 5).

After reception and acknowledgement of a correct address (byte 1), the first bit of the following byte determines whether the byte is interpreted as a byte 2 or 4, a logic '0' indicating byte 2, and a logic '1' indicating byte 4. Having interpreted this byte as either byte 2 or 4, the following data byte will be interpreted as byte 3 or 5 respectively. Having received two complete data bytes, additional data bytes can be entered, where byte interpretation follows the same procedure, without re-addressing the device. This procedure continues until a STOP condition is received. The STOP condition can be generated after any data byte, if however it occurs during a byte transmission, the previous

byte data is retained. To facilitate smooth fine tuning, the frequency data bytes are only accepted by the device after all 15 bits of frequency data have been received, or after the generation of a STOP condition.

Read mode

When the device is in read mode, the status byte read from the device takes the form shown in Table 3.

Bit 1 (POR) is the power-on reset indicator, and this is set to a logic '1' if the V_{CC} supply to the device has dropped below 3V (at 25°C), e.g. when the device is initially turned on. The POR is reset to '0' when the read sequence is terminated by a STOP command. When POR is set high this indicates the programmed information may be corrupted and the device reset to power up condition.

Bit 2 (FL) indicates whether the device is phase locked, a logic '1' is present if the device is locked, and a logic '0' if it is not.

Programmable features

- **RF programmable divider** Function as described above.
- **Reference programmable divider** Function as described above.
- **Charge pump current** The charge pump current can be programmed by bits C1 and C0 within data byte 5, as defined in Table 6.
- **Test mode** The test modes are invoked by setting bit T2 = 1, with selected test modes as defined by bits T1 and T0 as described in Table 5. Clock input on crystal and RF input pins are required to invoke FL test modes.
- **Reference/Comparison frequency output** The reference frequency f_{REF} or comparison frequency f_{COMP} can be switched to the REF/COMP output, function as defined in Table 7. RE and RS default to logic '1' during device power up, thus enabling the comparison frequency f_{COMP} at the REF/COMP output.

	MSB					LSB				
Address	1	1	0	0	0	MA1	MA0	0	A	Byte 1
Programmable divider	0	2^{14}	2^{13}	2^{12}	2^{11}	2^{10}	2^9	2^8	A	Byte 2
Programmable divider	2^7	2^6	2^5	2^4	2^3	2^2	2^1	2^0	A	Byte 3
Control data	1	T2	T1	T0	R3	R2	R1	R0	A	Byte 4
Control data	C1	C0	RE	RS	P3	P2	P1	P0	A	Byte 5

Table 2 Write data format (MSB transmitted first)

- A** Acknowledge bit
- MA1, MA0** Variable address bits (see Table 4)
- 2^{14} - 2^0** Programmable division ratio control bits
- R3-R0** Reference division ratio select (see Table 1)
- C1, C0** Charge pump current select (see Table 6)
- RE** Reference oscillator output enable
- RS** REF/COMP output select when RE=1 (see Table 7)
- T2-T0** Test mode control bits (see Table 5)
- P3-P0** P3, P2, P1 and P0 port output states

	MSB					LSB				
Address	1	1	0	0	0	MA1	MA0	1	A	Byte 1
Status byte	POR	FL	0	0	0	0	0	0	A	Byte 2

Table 3 Read data format (MSB transmitted first)

A Acknowledge bit
MA1, MA0 Variable address bits (see Table 4)
POR Power On Reset indicator
FL Phase lock flag

MA1	MA0	Address input voltage level
0	0	0 to 0.1V _{CC}
0	1	Open circuit
1	0	0.4V _{CC} to 0.6V _{CC} *
1	1	0.9V _{CC} to V _{CC}

* Programmed by connecting a 15kΩ resistor from pin 10 to V_{CC}

Table 4 Address selection

T2	T1	T0	Test mode description
0	X	X	Normal operation
1	0	0	Charge pump sink Status byte FL = logic '0'
1	0	1	Charge pump source Status byte FL = logic '0'
1	1	0	Charge pump disable Status byte FL = logic '1'
1	1	1	P0 = f _{PD} /2

Table 5 Test modes

C1	C0	Current (μA)		
		Min.	Typ.	Max.
0	0	±116	±155	±194
0	1	±247	±330	±412
1	0	±517	±690	±862
1	1	±1087	±1450	±1812

Table 6 Charge pump current

RE	RS	REF/COMP output
0	X	High impedance
1	0	f _{REF} selected
1	1	f _{COMP} selected

Table 7 REF/COMP output

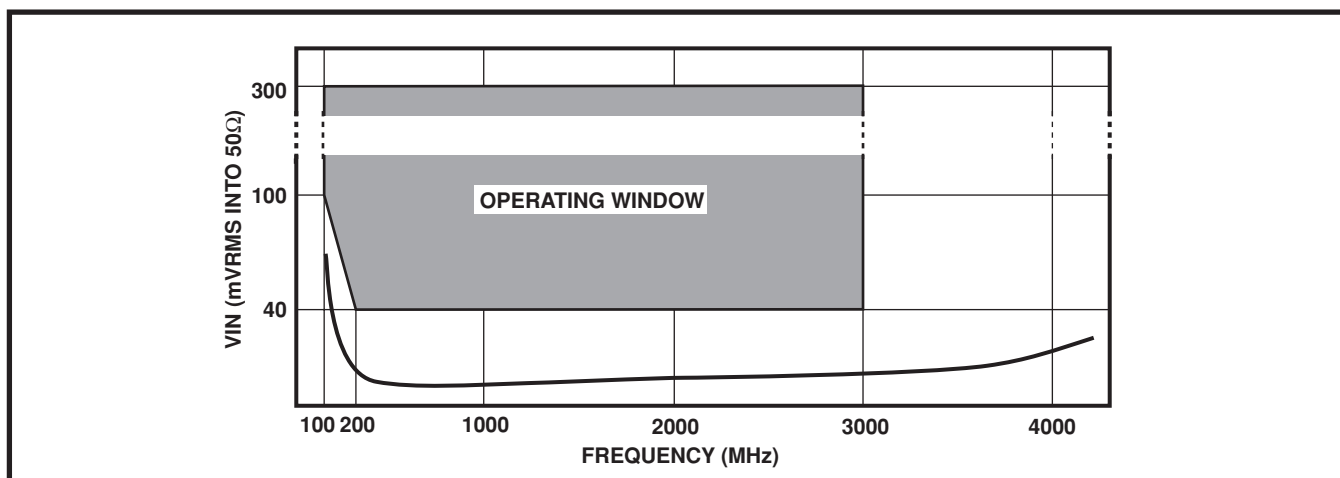

Figure 3 Typical RF input sensitivity

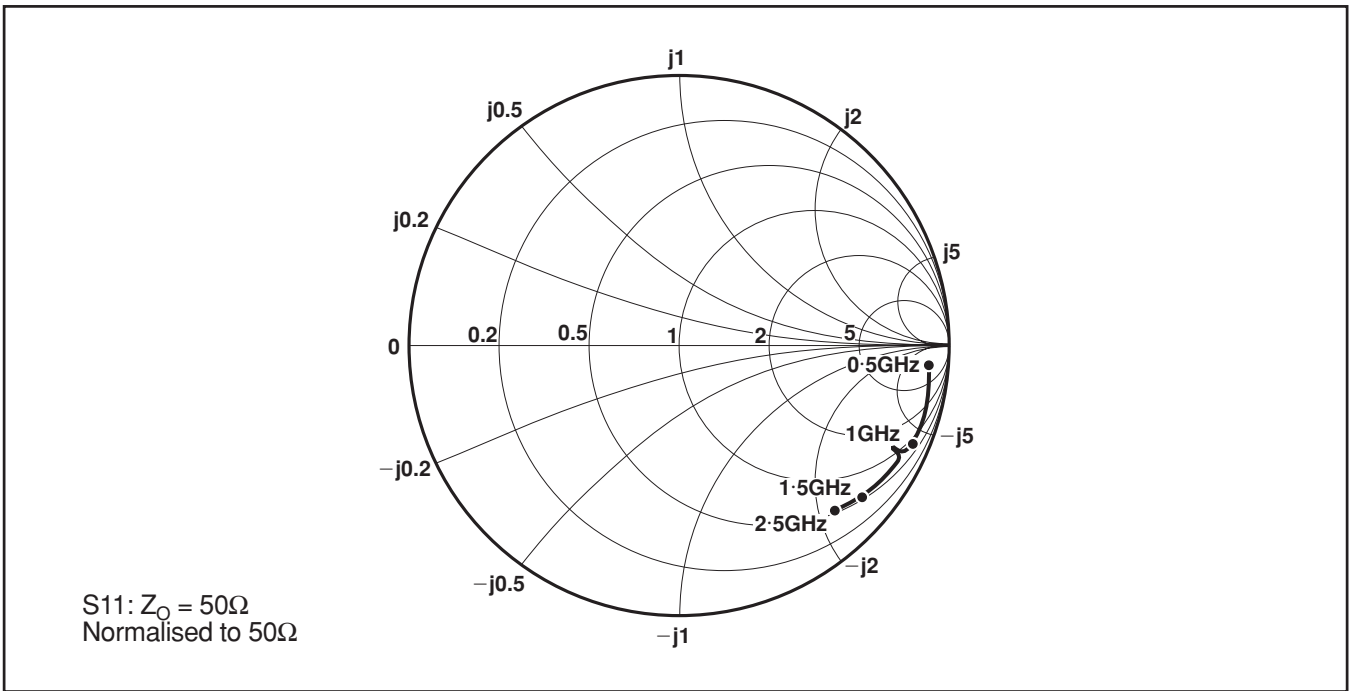

Figure 4 RF input impedance

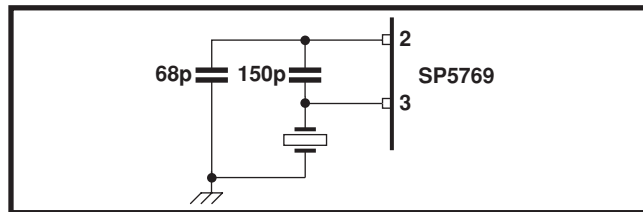

Figure 5 Crystal oscillator application

Component	Value/type	Component	Value/type
C1	18pF	C22	100pF
C2	2.2nF	C23	4.7μF
C3	68pF	C24	1nF
C4	1nF	LED 1	HLMPK-150
C5	1nF	LED 2	HLMPK-150
C6	10nF	R1	4.7kΩ
C7	100nF	R4	4.7kΩ
C8	4.7μF	R5	4.7kΩ
C9	100nF	R6	4.7kΩ
C10	100pF	R7	13.3kΩ
C11	1nF	R8	22kΩ
C12	100pF	R9	1kΩ
C13	100pF	R10	0Ω
C14	4.7nF	R11	16Ω
C15	100pF	R12	16Ω
C16	4.7μF	R13	16Ω
C17	10nF	R14	68Ω
C18	39pF	S1	SW DIP-2
C19	100pF	T1	BCW31
C20	1nF	VCO	POS_2000
C21	1nF	X1	4MHz

Table 8 Component values for Figure 6

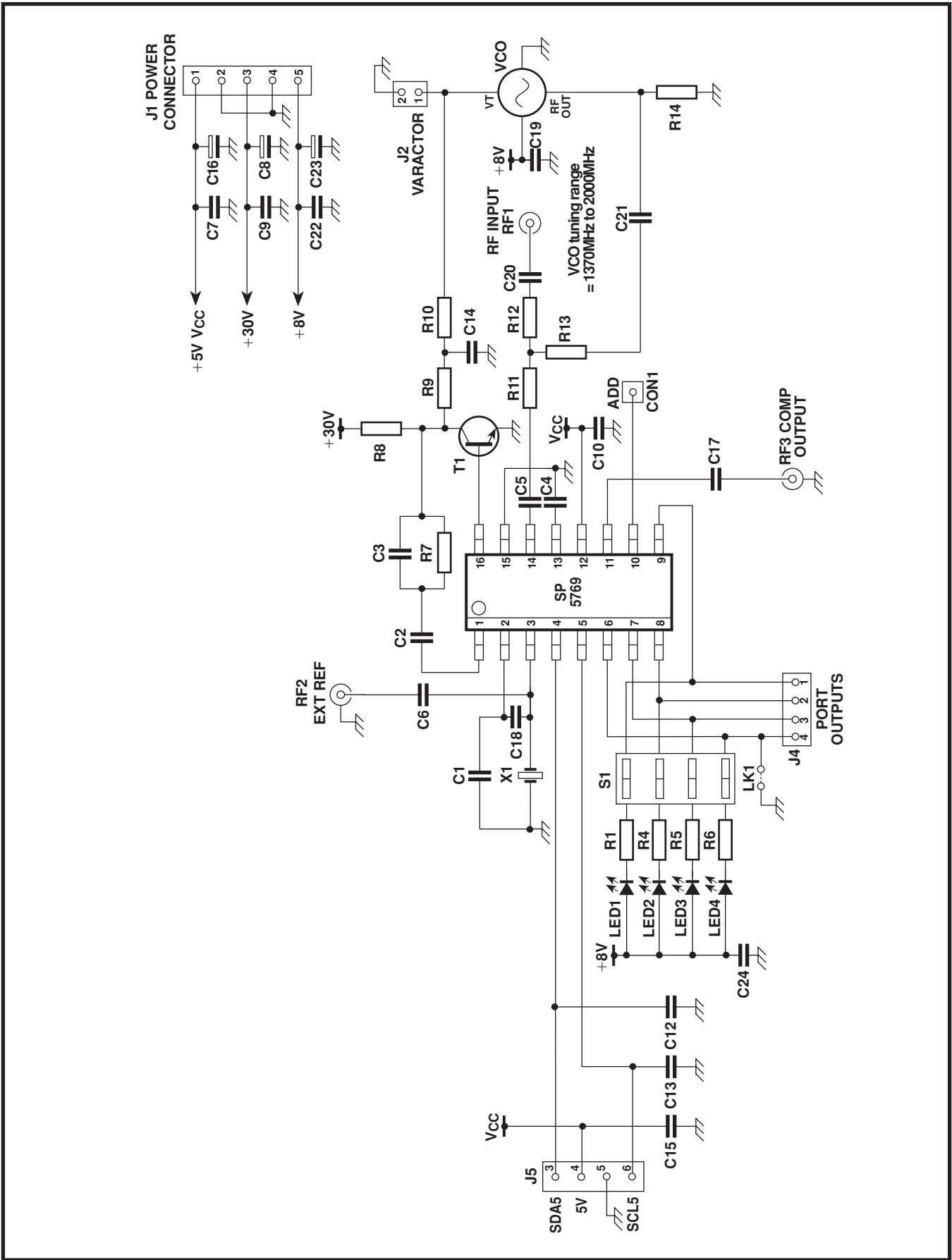

Figure 6 SP5769 evaluation board

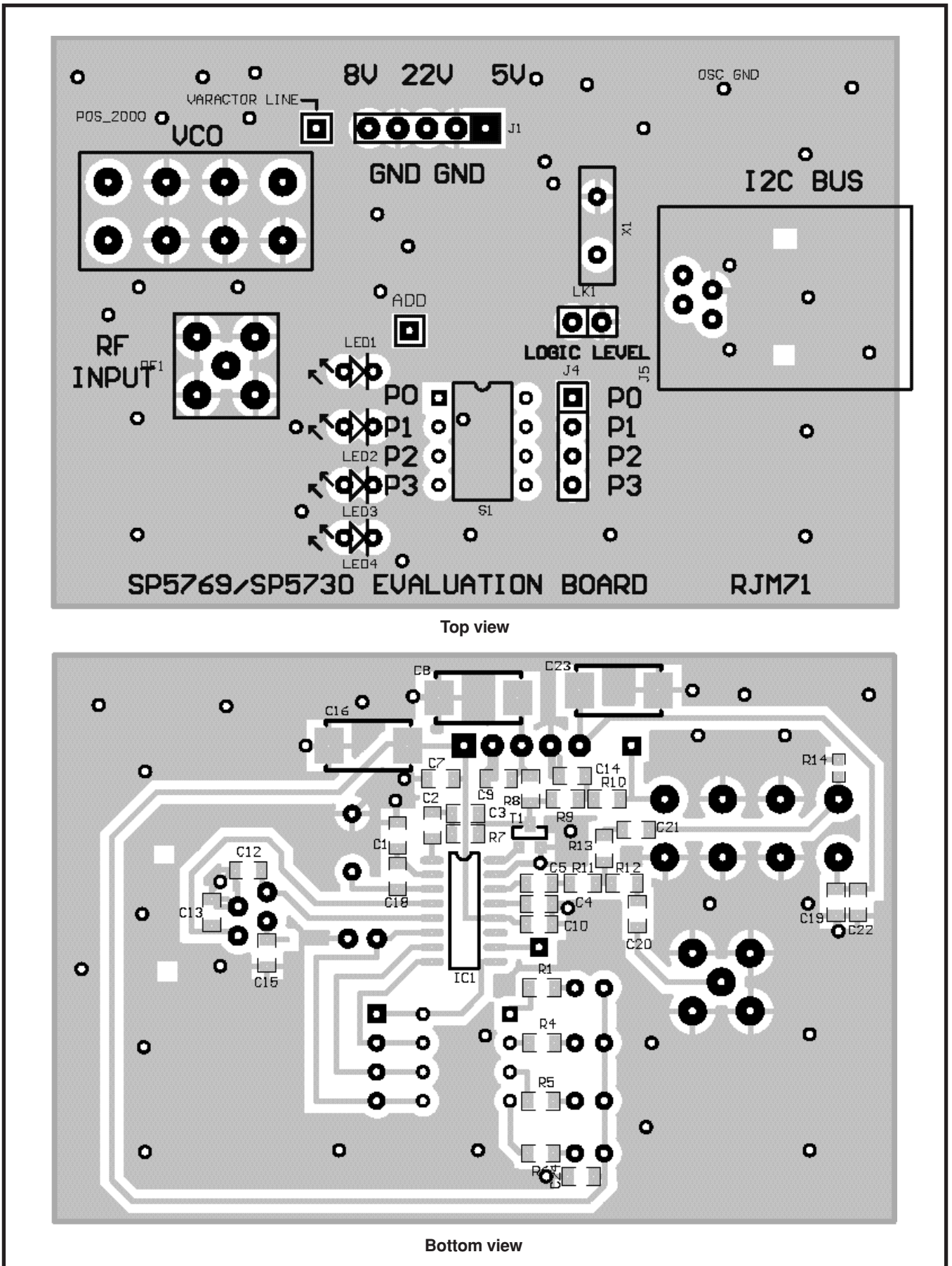
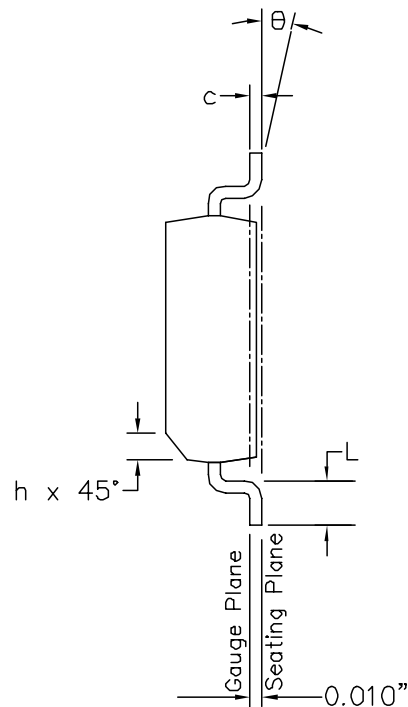
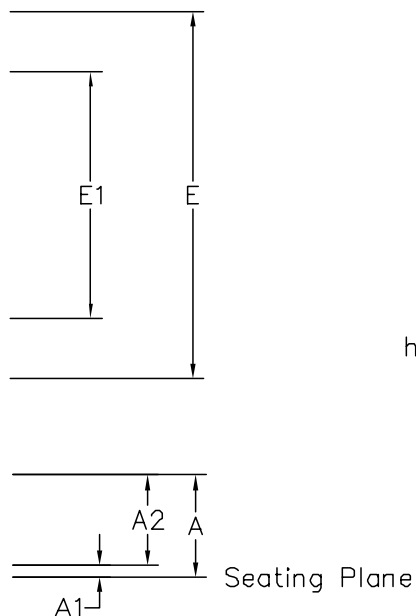
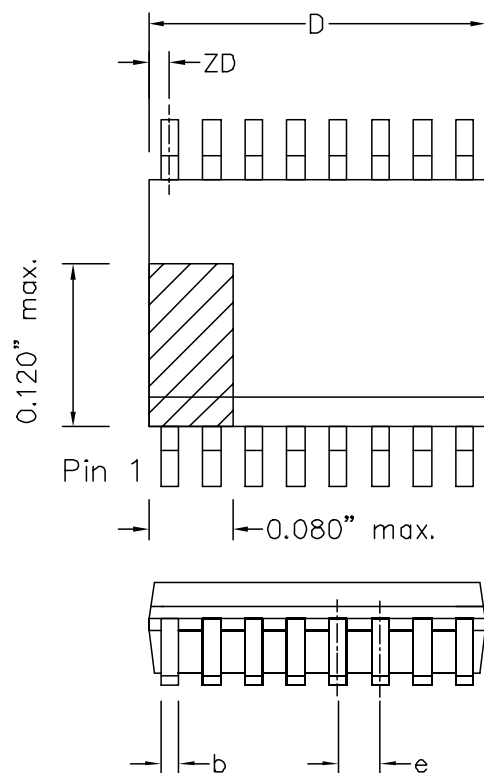

Figure 7 SP5769 evaluation board layout



Symbol	Control Dimensions in inches		Altern. Dimensions in millimetres	
	MIN	MAX	MIN	MAX
A	0.053	0.069	1.35	1.75
A1	0.004	0.010	0.10	0.25
A2	—	0.059	—	1.50
D	0.189	0.197	4.80	5.00
ZD	0.009	REF.	0.23	REF.
E	0.228	0.244	5.79	6.20
E1	0.150	0.157	3.81	3.99
L	0.016	0.050	0.41	1.27
e	0.025	BSC.	0.64	BSC.
b	0.008	0.012	0.20	0.30
c	0.007	0.010	0.18	0.25
θ	0°	8°	0°	8°
h	0.010	0.020	0.25	0.50
Pin features				
N	16			
Conforms to JEDEC MO-137AB Iss. A				

This drawing supersedes
418/ED/51617/001 (Swindon/Roborough)
TD/D 1028 (Oldham)

Notes:

1. The chamfer on the body is optional. If it is not present, a visual index feature, e.g. a dot, must be located within the cross-hatched area.
2. Controlling dimensions are in inches.
3. Dimension D do not include mould flash, protrusion or gate burrs. These shall not exceed $0.006''$ per side.
4. Dimension $E1$ do not include inter-lead flash or protrusion. These shall not exceed $0.010''$ per side.
5. Dimension b does not include dambar protrusion/intrusion. Allowable dambar protrusion shall be $0.004''$ total in excess of b dimension.

© Mitel

ORIGINATING SITE: SWINDON

ISSUE	1	2			
ACN	201928	207313			
DATE	27FEB97	24AUG99			
APPRD.					

MITEL SEMICONDUCTOR

Title:
Package Outline Drawing for
16L QSOP-0.150" Body Width(QP)

Drawing Number
GPD00290

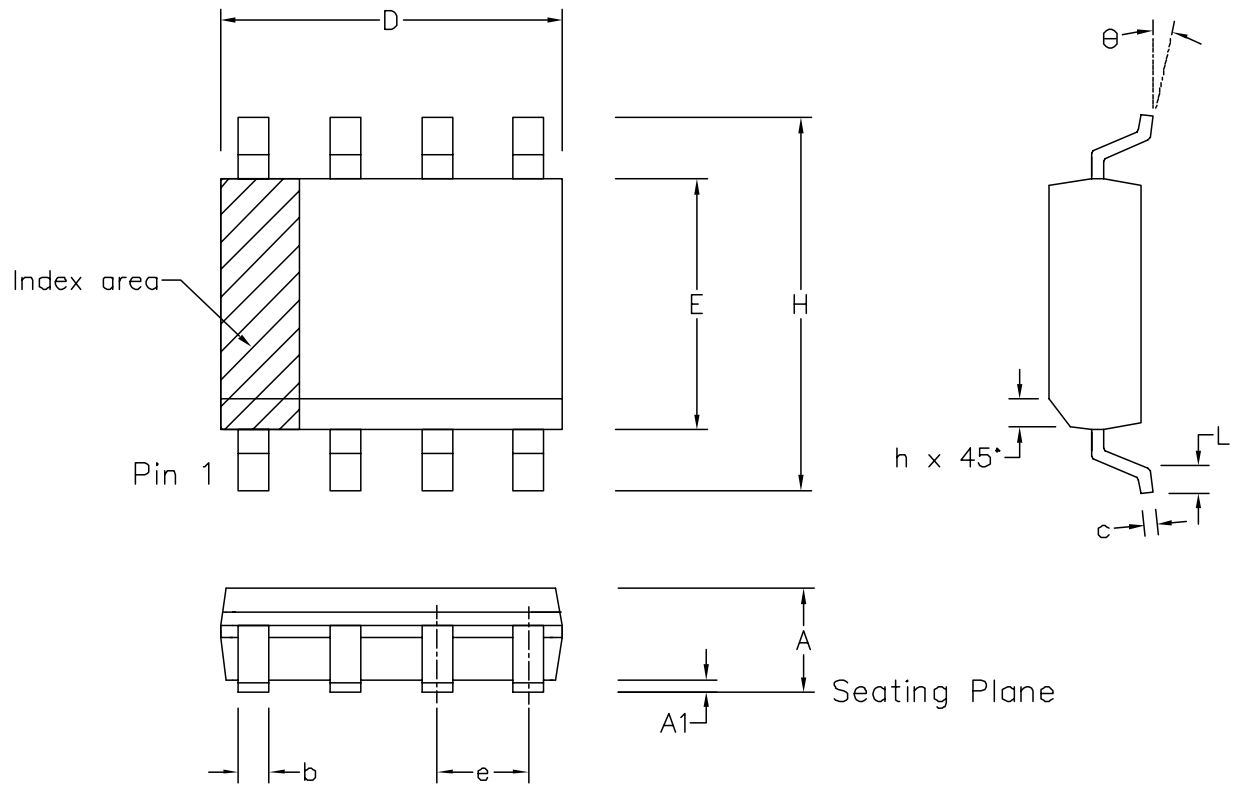

	Min mm	Max mm	Min inch	Max inch
A	1.35	1.75	0.053	0.069
A1	0.10	0.25	0.004	0.010
D	9.80	10.00	0.386	0.394
H	5.80	6.20	0.228	0.244
E	3.80	4.00	0.150	0.157
L	0.40	1.27	0.016	0.050
e	1.27 BSC		0.050 BSC	
b	0.33	0.51	0.013	0.020
c	0.19	0.25	0.008	0.010
O	0°	8°	0°	8°
h	0.25	0.50	0.010	0.020
Pin Features				
N	16		16	
Conforms to JEDEC MS-012AC Iss. C				

Notes:

1. The chamfer on the body is optional. If it not present, a visual index feature, e.g. a dot, must be located within the cross-hatched area.
2. Controlling dimension are in inches.
3. Dimension D do not include mould flash, protusion or gate burrs. These shall not exceed 0.006" per side.
4. Dimension E1 do not include inter-lead flash or protusion. These shall not exceed 0.010" per side.
5. Dimension b does not include dambar protusion/intrusion. Allowable dambar protusion shall be 0.004" total in excess of b dimension.

© Mitel						MITEL SEMICONDUCTOR
ISSUE	1	2	3	4		
ACN	006745	201938	202597	203706		
DATE	7APR95	27FEB97	12JUN97	9DEC97		
APPROVED						

ORIGINATING SITE: SWINDON
Title: Package Outline Drawing for 16 lds SOIC(N)-0.150" Body Width (MP)
Drawing Number GPD00012



<http://www.mitelsemi.com>

World Headquarters - Canada

Tel: +1 (613) 592 2122
Fax: +1 (613) 592 6909

North America

Tel: +1 (770) 486 0194
Fax: +1 (770) 631 8213

Asia/Pacific

Tel: +65 333 6193
Fax: +65 333 6192

**Europe, Middle East,
and Africa (EMEA)**

Tel: +44 (0) 1793 518528
Fax: +44 (0) 1793 518581

Information relating to products and services furnished herein by Mitel Corporation or its subsidiaries (collectively "Mitel") is believed to be reliable. However, Mitel assumes no liability for errors that may appear in this publication, or for liability otherwise arising from the application or use of any such information, product or service or for any infringement of patents or other intellectual property rights owned by third parties which may result from such application or use. Neither the supply of such information or purchase of product or service conveys any license, either express or implied, under patents or other intellectual property rights owned by Mitel or licensed from third parties by Mitel, whatsoever. Purchasers of products are also hereby notified that the use of product in certain ways or in combination with Mitel, or non-Mitel furnished goods or services may infringe patents or other intellectual property rights owned by Mitel.

This publication is issued to provide information only and (unless agreed by Mitel in writing) may not be used, applied or reproduced for any purpose nor form part of any order or contract nor to be regarded as a representation relating to the products or services concerned. The products, their specifications, services and other information appearing in this publication are subject to change by Mitel without notice. No warranty or guarantee express or implied is made regarding the capability, performance or suitability of any product or service. Information concerning possible methods of use is provided as a guide only and does not constitute any guarantee that such methods of use will be satisfactory in a specific piece of equipment. It is the user's responsibility to fully determine the performance and suitability of any equipment using such information and to ensure that any publication or data used is up to date and has not been superseded. Manufacturing does not necessarily include testing of all functions or parameters. These products are not suitable for use in any medical products whose failure to perform may result in significant injury or death to the user. All products and materials are sold and services provided subject to Mitel's conditions of sale which are available on request.

M Mitel (design) and ST-BUS are registered trademarks of MITEL Corporation
Mitel Semiconductor is an ISO 9001 Registered Company
Copyright 1999 MITEL Corporation
All Rights Reserved
Printed in CANADA

TECHNICAL DOCUMENTATION - NOT FOR RESALE