

RDS / RBDS decoder

BU1924 / BU1924F / BU1924FS

The BU1924, BU1924F and BU1924FS are RDS / RBDS decoders that employ a digital PLL and have a built-in anti-aliasing filter and an eight-stage BPF (switched-capacitor filter). Linear CMOS circuitry is used for low power consumption.

●Applications

RDS / RBDS compatible FM receivers for American and European markets, car stereos, high-fidelity stereo systems and components, and FM pagers.

●Features

- 1) Low current.
- 2) Two-stage anti-aliasing filter (LPF).
- 3) 57kHz band-pass filter.
- 4) DSB demodulation (digital PLL).
- 5) Quality indication output for demodulated data.

●Absolute maximum ratings (Ta = 25°C)

Parameter	Symbol	Limits	Unit	Conditions
Power supply voltage	V _{DD}	-0.3~+7.0	V	V _{DD1} V _{DD2}
Maximum input voltage	V _{Max.}	-0.3~V _{DD} +0.3	V	All input pins
Maximum output voltage	I _{Max.}	±4.0	mA	All output pins
Power dissipation	P _d	1000* ¹ (BU1924)	mW	-
		300* ² (BU1924F)		
		500* ³ (BU1924FS)		
Operating temperature	T _{opr}	-40~+85	°C	-
Storage temperature	T _{stg}	-55~+125	°C	-

*1 Reduced by 10.0mW for each increase in Ta of 1°C over 25°C.(BU1924)

*2 Reduced by 3.0mW for each increase in Ta of 1°C over 25°C.(BU1924F)

*3 Reduced by 5.0mW for each increase in Ta of 1°C over 25°C.(BU1924FS)

●Recommended operating conditions (Ta = 25°C)

Parameter	Symbol	Min.	Typ.	Max.	Unit
Power supply voltage	V _{DD1}	2.7	-	5.5	V
	V _{DD2}	2.7	-	5.5	V

Audio ICs

●Block diagram

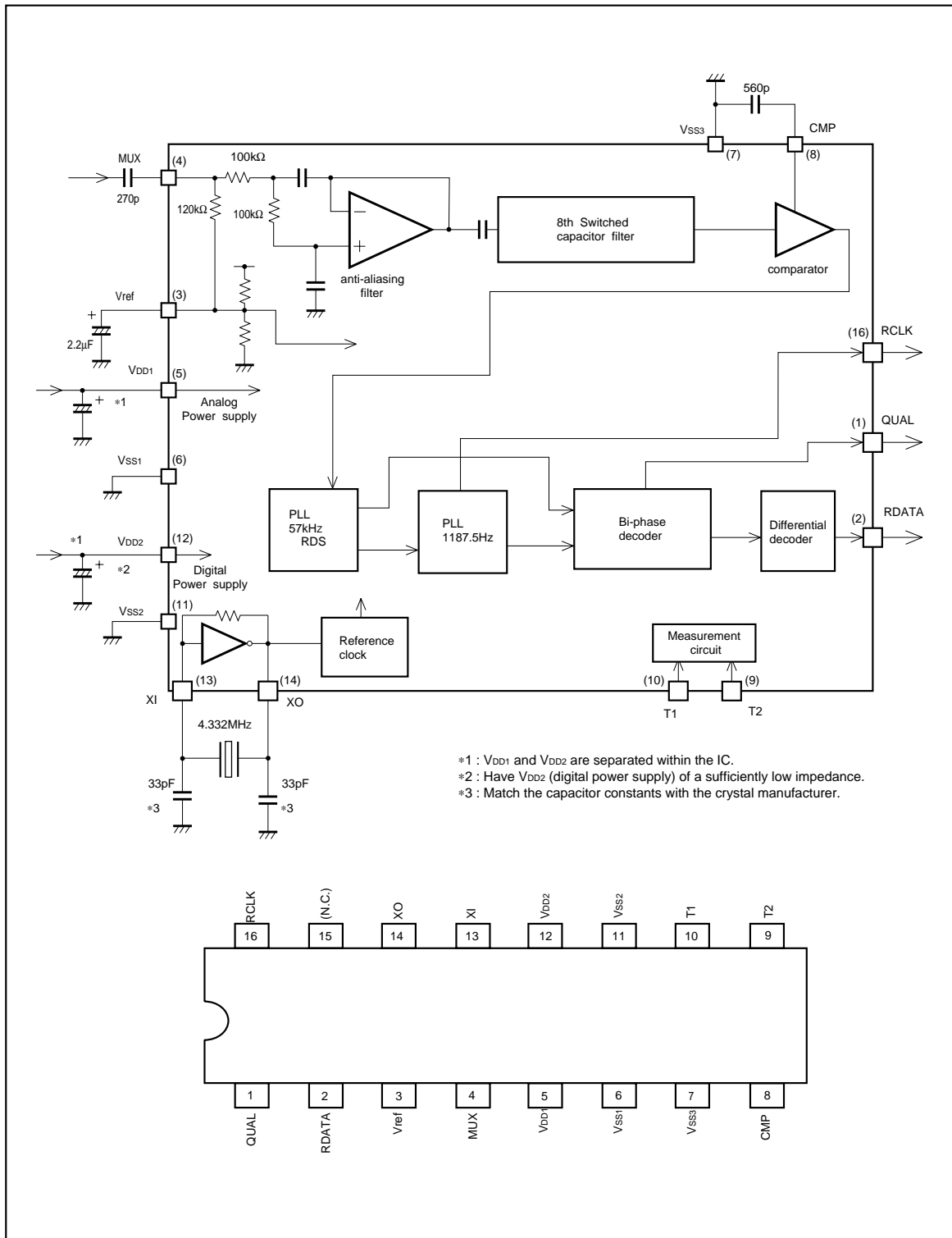

Audio ICs

●Pin descriptions

Pin No.	Symbol	Pin name	Functions	Input/Output type
1	QUAL	Demodulator quality	Good data : High, bad data : Low	Type C
2	RDATA	Demodulator data	Refer to output data timing	Type C
3	Vref	Reference voltage	1/2 V _{DD1} (refer to input/output circuits)	Type E
4	MUX	Input	Composite signal input (refer to input/output circuits)	Type F
5	V _{DD1}	Analog power supply	2.7V to 5.5V	-
6	V _{SS1}			
7	V _{SS3}			
8	CMP	Comparator input	C-junction (refer to input/output circuits)	Type D
9	T2	Test input	Open or connected to ground	Type B
10	T1			
11	V _{SS2}	Digital power supply	2.7V to 5.5V	-
12	V _{DD2}			
13	XI	Crystal oscillator	Connects to 4.332MHz oscillator (refer to input/output circuits)	Type A
14	XO			
15	(N.C.)	-	-	-
16	RCLK	Demodulator clock	1187.5Hz clock (refer to the timing diagram)	Type C

●Input / Output circuits

Type A

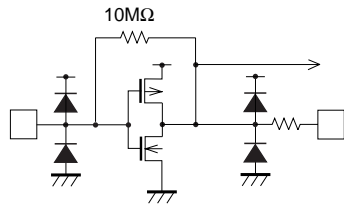

Type B

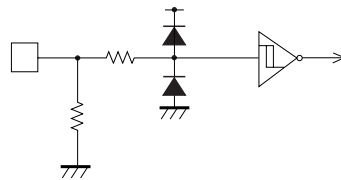

Type C

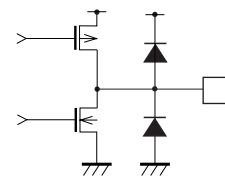

Type D

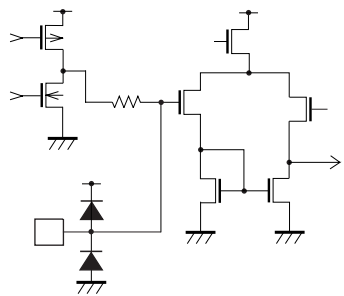

Type E

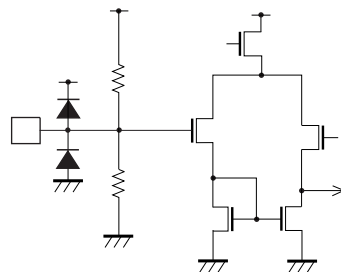

Type F

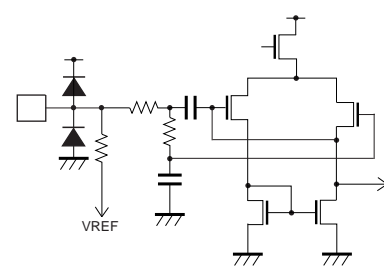

● **Electrical characteristics** (unless otherwise noted, Ta = 25°C, V_{DD1} = V_{DD2} = 5.0V, V_{SS1} = V_{SS2} = V_{SS3} = 0.0V)

Parameter	Symbol	Min.	Typ.	Max.	Unit	Conditions
Operating current	I _{DD}	–	6.5	10.0	mA	I _{DD1} +I _{DD2}
Reference voltage	V _{ref}	–	1/2V _{DD1}	–	V	Pin 3
Input current 1	I _{IN1}	–	–	1.0	μA	MUX V _{IN} =V _{DD1}
Output current 1	I _{OUT1}	–	–	1.0	μA	MUX V _{IN} =V _{SS1}
Input current 2	I _{IN2}	–	0.5	–	μA	XI XI=V _{DD2}
Output current 2	I _{OUT2}	–	0.5	–	μA	XI XI=V _{SS2}
Output high level voltage 1	V _{OH1}	V _{DD2} –1.0	V _{DD2} –0.3	–	V	RCLK RDATA QUAL I _o =–1.0mA
Output low level voltage 1	V _{OL1}	–	0.2	1.0	V	RCLK RDATA QUAL I _o =1.0mA

⟨Filter block⟩

Center frequency	FC	56.5	57.0	57.5	kHz	
Gain	GA	20	23	26	dB	F=57.0kHz
Attenuation 1	ATT1	18	22	–	dB	57kHz±4kHz
Attenuation 2	ATT2	65	80	–	dB	38kHz
Attenuation 3	ATT3	35	50	–	dB	67kHz
S / N ratio	SN	–	35	–	dB	57kHz V _{IN} =3.0mVrms

⟨Demodulator⟩

RDS detector sensitivity	SRDS	–	0.5	1.0	mVrms	
RDS input level	VRDS	1.0	–	300	mVrms	
Data rate	DRATE	–	1187.5	–	Hz	
Clock transient vs. data	CT	–	4.3	–	μs	

© Not designed for radiation resistance.

● **Output data timing**

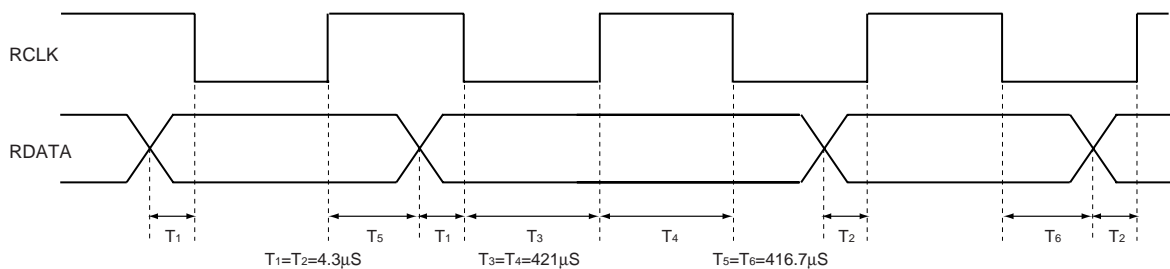

The clock (RCLK) frequency is 1187.5Hz. Depending on the state of the internal PLL clock, the data (RDATA) is replaced in synchronous with either the rising or falling or falling edge of the clock. To read the data, you may choose either the rising or falling edge of the clock as the reference. The data is valid for 416.7μs. after the reference clock edge.

QUAL pin operation : Indicates the quality of the demodulated data.

- (1) Good data : HI
- (2) Poor data : LO

Audio ICs

●Electrical characteristic curves

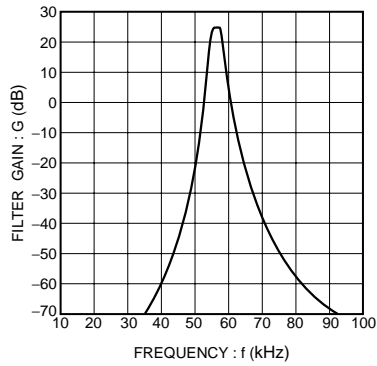

Fig.1 Band-pass filter characteristics

●External dimensions (Units : mm)

