

Features

- Oscillator is provided on the monolithic control with adopting On-Chip-Trimming technology.
- Small temperature characteristics variation by adopting a comparator to compensate for temperature on the control part.
- Low start-up circuit current (50uA max)
- Built-in Active Low-Pass Filter for stabilizing the operation in case of light load
- Avalanche energy guaranteed MOSFET with high VDSS
 - The built-in power MOSFET simplifies the surge absorption circuit since the MOSFET guarantees the avalanche energy.
 - No VDSS de-rating is required.
- Built-in constant voltage drive circuit
- Various kinds of protection functions
 - Pulse-by-pulse Overcurrent Protection (OCP)
 - Overvoltage Protection with latch mode (OVP)
 - Thermal Shutdown with latch mode (TSD)

INTEGRATED SWITCHER

Package Outline

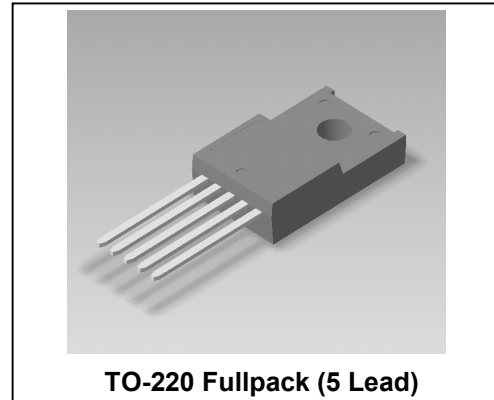

Key Specifications

Type	MOSFET VDSS(V)	RDS(ON) MAX	AC input(V)	Pout(W) Note 1
IRIS-G6353	650	1. 90 Ω	230 ± 15%	120
			85 to 264	58

Note 1: The Pout (W) represents the thermal rating at PRC Operation, and the peak power output is obtained by approximately 120 to 140% of the above listed. When the output voltage is low and ON-duty is narrow, the Pout (W) shall become lower than that of above.

Descriptions

IRIS-G6353 is a hybrid IC consists from power MOSFET and a controller IC, designed for PRC fly-back converter type SMPS (Switching Mode Power Supply) applications. This IC realizes downsizing and standardizing of a power supply system reducing external components count and simplifying the circuit designs.

(Note). PRC is abbreviation of “Pulse Ratio Control” (On-width control with fixed OFF-time).

Typical Connection Diagram

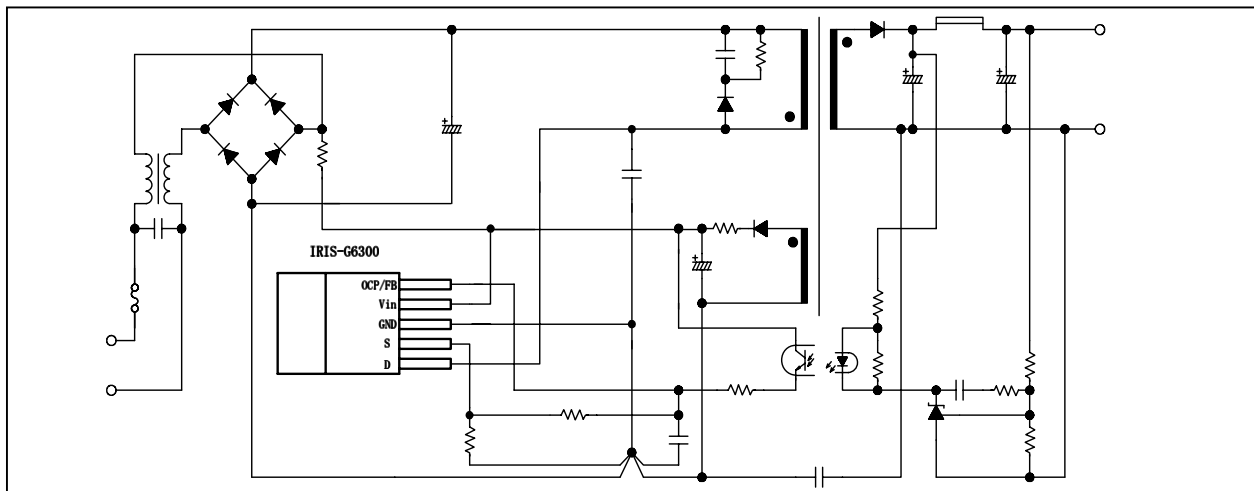

Absolute Maximum Ratings (Ta=25°C)

Absolute maximum ratings indicate sustained limits beyond which damage to the device may occur. All voltage parameters are absolute voltages referenced to terminals stated, all currents are defined positive into any lead. The thermal resistance and power dissipation ratings are measured under board mounted and still air conditions.

Symbol	Definition	Terminals	Max. Ratings	Units	Note
IDpeak	Drain Current *1	1-2	10	A	Single Pulse
IDMAX	Maximum switching current *5	1-2	10	A	V ₂₋₃ =0.82V Ta=-20~+125°C
EAS	Single pulse avalanche energy *2	1-2	125	mJ	Single Pulse VDD=99V, L=20mH IL peak=3.2A
Vin	Input voltage for control part	4-3	35	V	
Vth	O.C.P/F.B Pin voltage	5-3	6	V	
PD1	Power dissipation for MOSFET *3	1-2	26	W	With infinite heatsink
			1.5	W	Without heatsink
PD2	Power dissipation for control part (Control IC) *4	4-3	0.14	W	Specified by Vin × Iin
TF	Internal frame temperature in operation	-	-20 ~ +125	°C	Refer to recommended operating temperature
Top	Operating ambient temperature	-	-20 ~ +125	°C	
Tstg	Storage temperature	-	-40 ~ +125	°C	
Tch	Channel temperature	-	150	°C	

*1 Refer to MOS FET A.S.O curve

*2 MOS FET Tch-EAS curve

*3 Refer to MOS FET Ta-PD1 curve

*4 Refer to TF-PD2 curve for Control IC (See page 5)

*5 Maximum switching current.

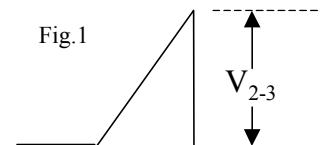

The maximum switching current is the Drain current determined by the drive voltage of the IC and threshold voltage (Vth) of MOS FET. Therefore, in the event that voltage drop occurs between Pin 2 and Pin 3 due to patterning, the maximum switching current decreases as shown by V₂₋₃ in Fig.1 Accordingly please use this device within the decrease value, referring to the derating curve of the maximum switching current.

Electrical Characteristics (for Control IC)

Electrical characteristics for control part (Ta=25°C, Vin=20V, unless otherwise specified)

Symbol	Definition	Ratings			Units	Test Conditions
		MIN	TYP	MAX		
V _{in(ON)}	Operation start voltage	15.8	17.6	19.4	V	V _{in} =0→19.4V
V _{in(OFF)}	Operation stop voltage *6	9.1	10.1	11.1	V	V _{in} =19.4→9.1V
I _{in(ON)}	Circuit current in operation	-	-	5	mA	-
I _{in(OFF)}	Circuit current in non-operation	-	-	50	μA	V _{in} =15V
T _{OFF(MAX)}	Maximum OFF time	12	15	18	μsec	-
V _{th}	O.C.P/F.B Pin threshold voltage	0.7	0.76	0.82	V	-
I _{OCP/FB}	O.C.P/F.B Pin extraction current	0.7	0.8	0.9	mA	-
V _{in(OVP)}	O.V.P operation voltage	23.2	25.5	27.8	V	V _{in} =0→27.8V
I _{in(H)}	Latch circuit sustaining current *7	-	-	70	μA	V _{in} =27.8→(V _{in(OFF)} -0.3)V
V _{in(La.OFF)}	Latch circuit release voltage *6,7	7.9	-	10.5	V	V _{in} =27.8→7.9V
T _{j(TSD)}	Thermal shutdown operating temperature	135	-	-	°C	-

*6 The relation of V_{IN(OFF)}>V_{IN(La.OFF)} is applied for each product

*7 The latch circuit means a circuit operated O.V.P and T.S.D.

Electrical Characteristics (for MOSFET)

(Ta=25°C) unless otherwise specified

Symbol	Definition	Ratings			Units	Test Conditions
		MIN	TYP	MAX		
V _{DSS}	Drain-to-Source breakdown voltage	650	-	-	V	ID=300μA
						V3-2=0V(short)
I _{DSS}	Drain leakage current	-	-	300	μA	V _D S=650V
						V3-2=0V(short)
R _D S(ON)	On-resistance	-	-	1.9	Ω	V3-2=10V
						ID=1.2A
t _f	Switching time	-	-	250	nsec	-
θ _{ch-F}	Thermal resistance	-	-	2	°C/W	Between channel and internal frame

IRIS-G6353

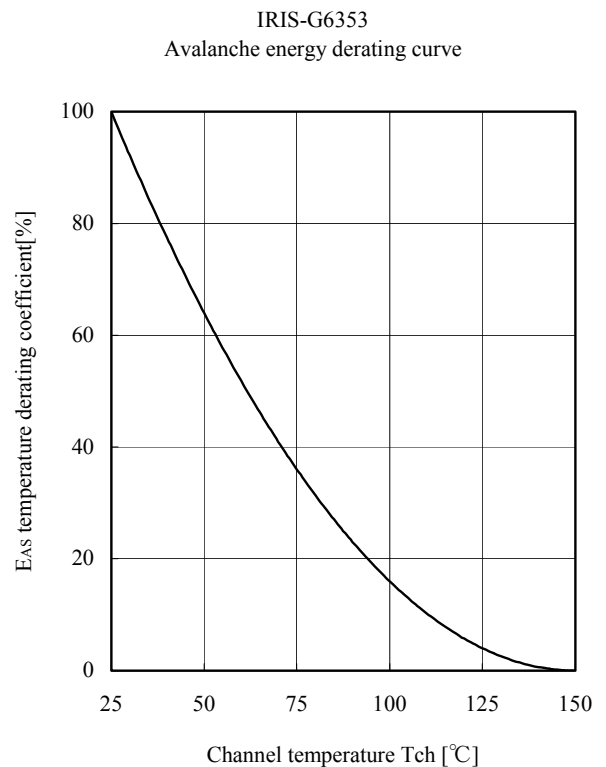
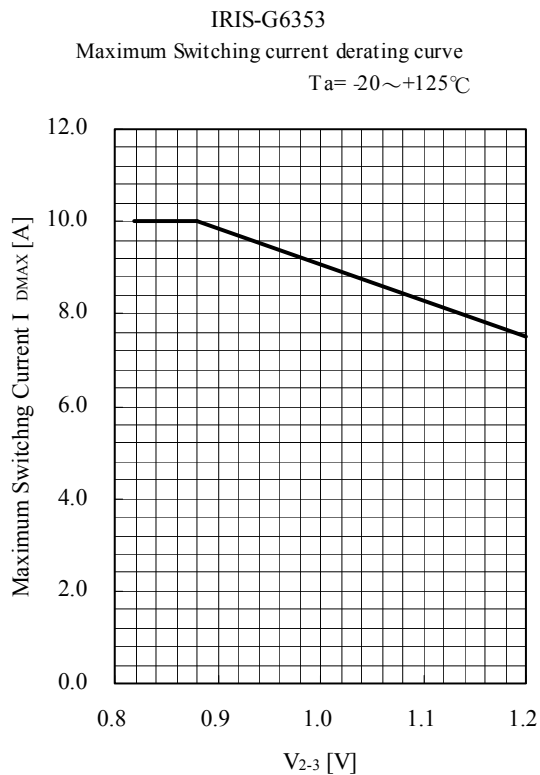
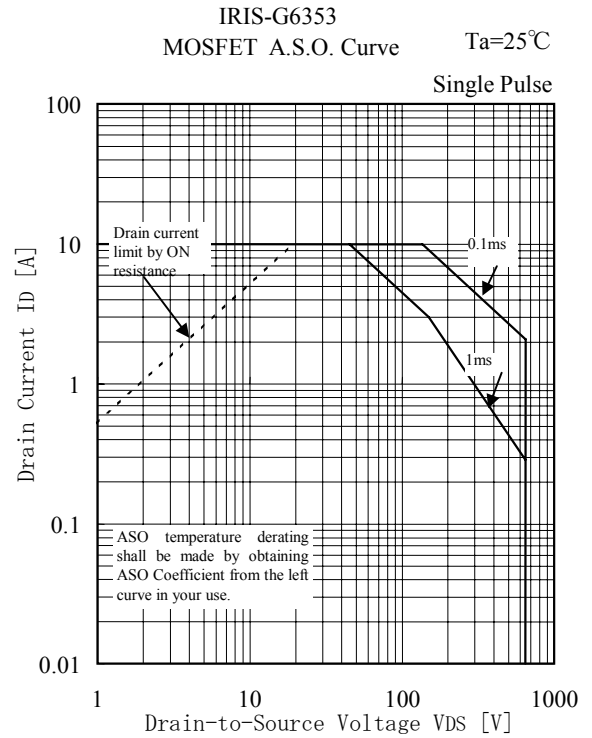
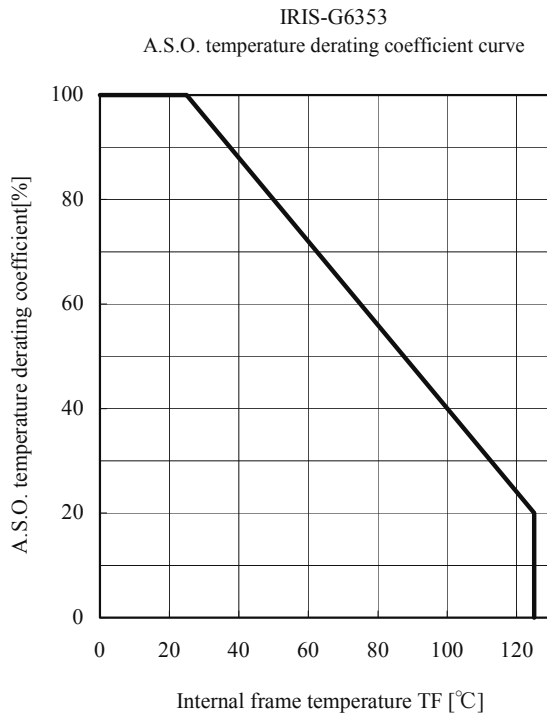

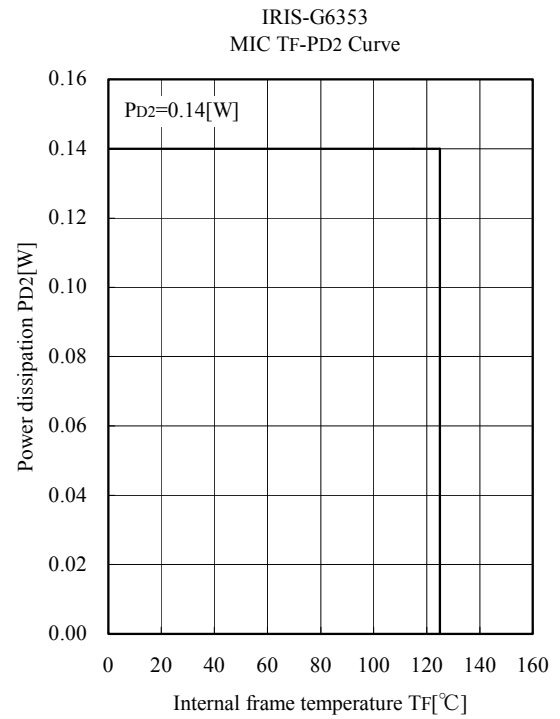
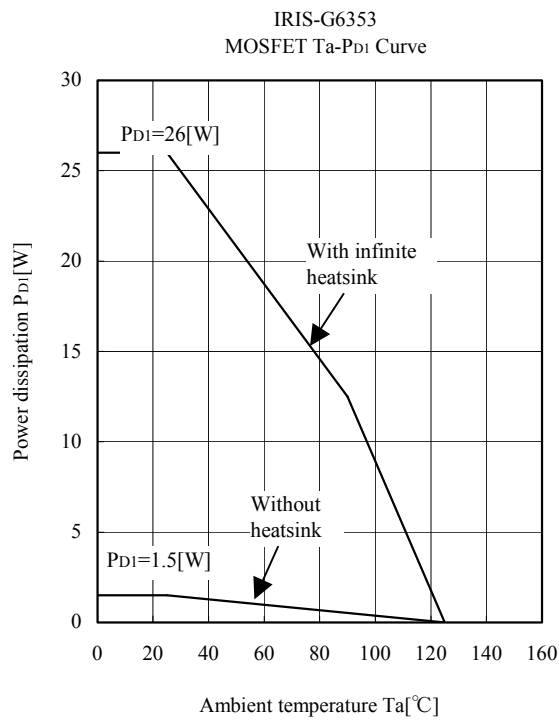

IRIS-G6353
Transient thermal resistance curve

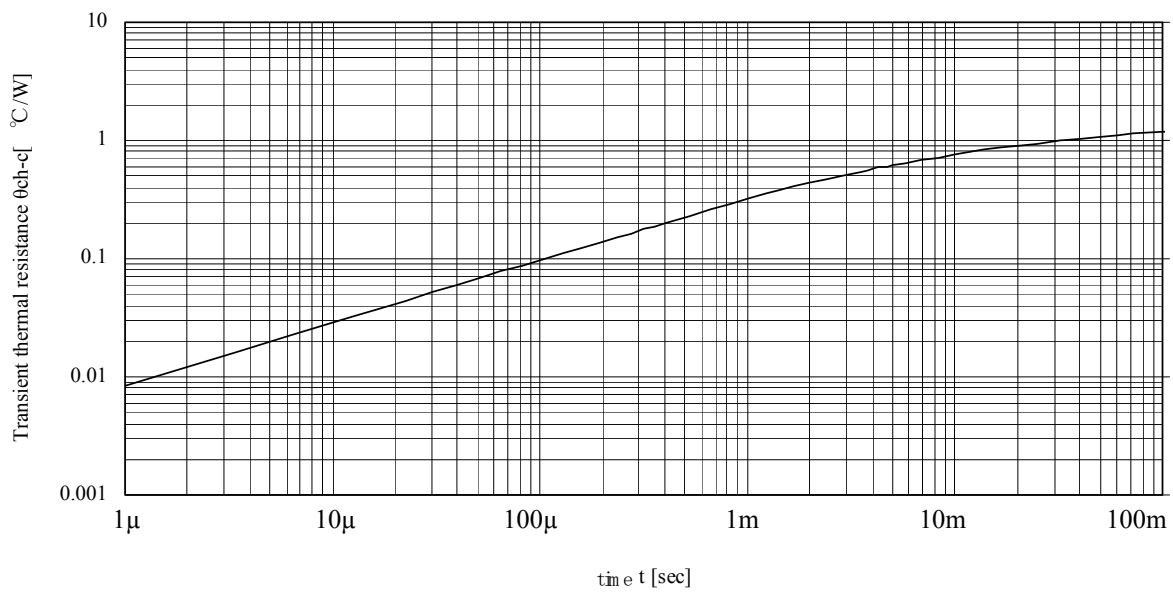

Block Diagram

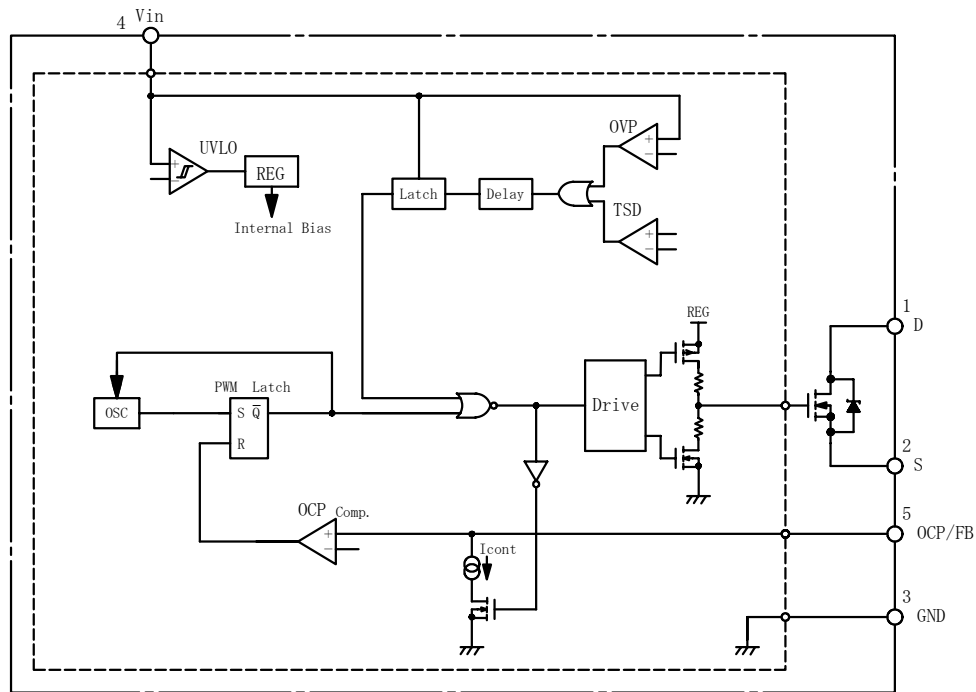

Lead Assignments

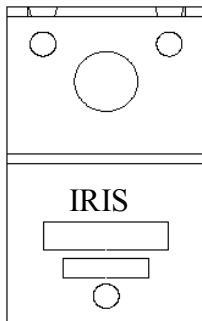

Pin No.	Symbol	Description	Function
1	D	Drain Pin	MOSFET drain
2	S	Source Pin	MOSFET source
3	GND	Ground Pin	Ground
4	Vin	Power supply Pin	Input of power supply for control circuit
5	OCP/FB	Overcurrent / Feedback Pin	Input of overcurrent detection
			signal / constant voltage control signal

Other Functions

O.V.P. – Overvoltage Protection Circuit

T.S.D. – Thermal Shutdown Circuit

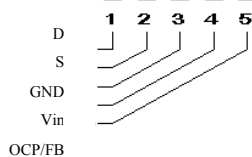

Case Outline

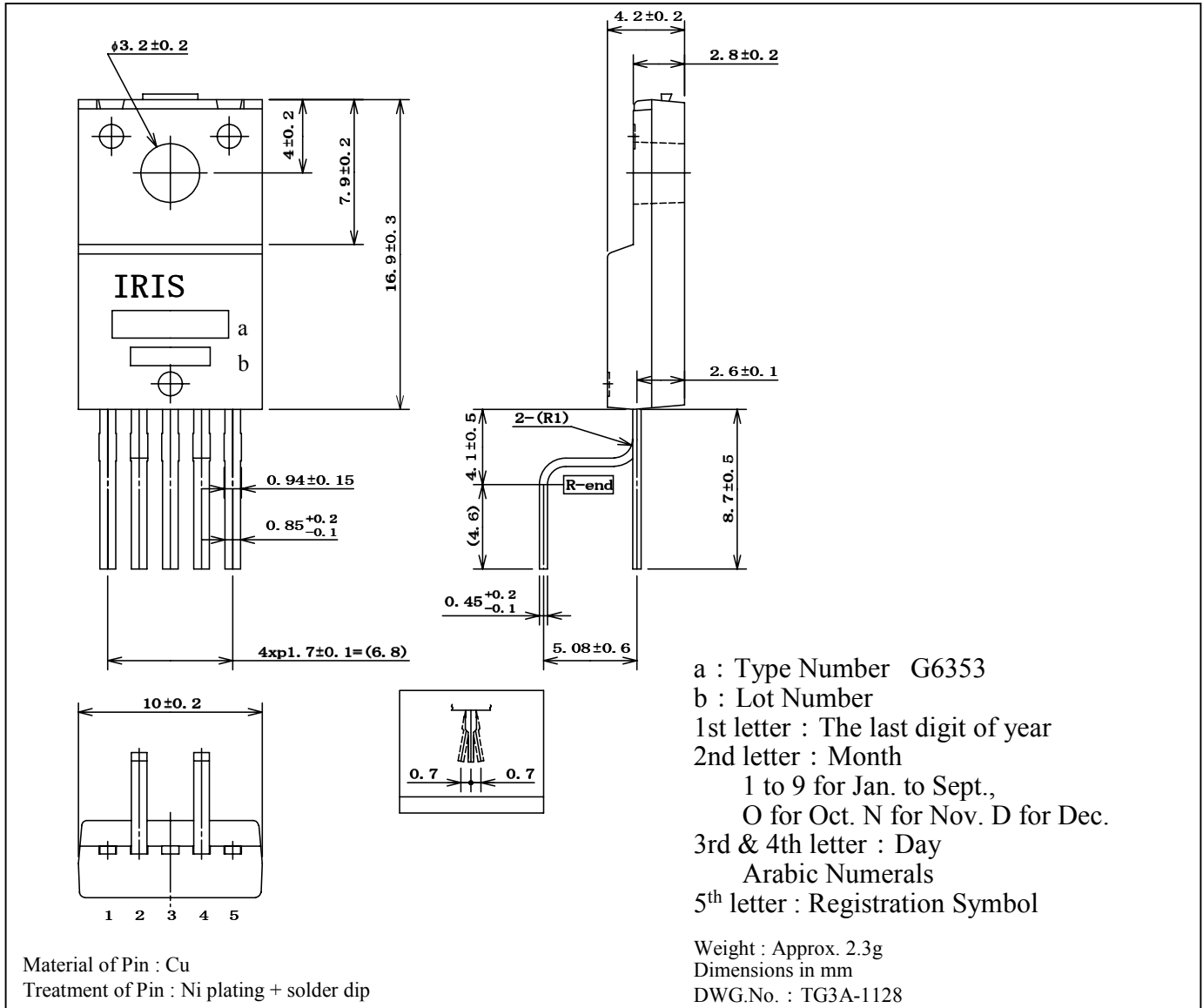

Data and specifications subject to change without notice.