

# IRF7319PbF

HEXFET® Power MOSFET

- Generation V Technology
- Ultra Low On-Resistance
- Dual N and P Channel MOSFET
- Surface Mount
- Fully Avalanche Rated
- Lead-Free

## Description

Fifth Generation HEXFETs from International Rectifier utilize advanced processing techniques to achieve extremely low on-resistance per silicon area. This benefit, combined with the fast switching speed and ruggedized device design that HEXFET Power MOSFETs are well known for, provides the designer with an extremely efficient and reliable device for use in a wide variety of applications.

The SO-8 has been modified through a customized leadframe for enhanced thermal characteristics and multiple-die capability making it ideal in a variety of power applications. With these improvements, multiple devices can be used in an application with dramatically reduced board space. The package is designed for vapor phase, infra red, or wave soldering techniques.

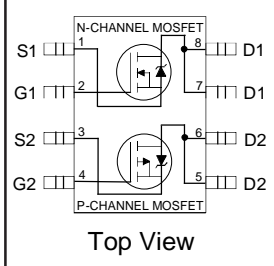
 <p>Top View</p>		<b>N-Ch</b>	<b>P-Ch</b>
	$V_{DS}$	30V	-30V
	$R_{DS(on)}$	0.029 $\Omega$	0.058 $\Omega$

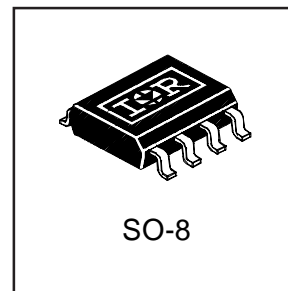

## Absolute Maximum Ratings ( $T_A = 25^\circ\text{C}$ Unless Otherwise Noted)

	Symbol	Maximum		Units	
		N-Channel	P-Channel		
Drain-Source Voltage	$V_{DS}$	30	-30	V	
Gate-Source Voltage	$V_{GS}$	$\pm 20$			
Continuous Drain Current <sup>①</sup>	$I_D$	$T_A = 25^\circ\text{C}$	6.5	-4.9	A
		$T_A = 70^\circ\text{C}$	5.2	-3.9	
Pulsed Drain Current	$I_{DM}$	30	-30		
Continuous Source Current (Diode Conduction)	$I_S$	2.5	-2.5		
Maximum Power Dissipation <sup>②</sup>	$P_D$	$T_A = 25^\circ\text{C}$	2.0		W
		$T_A = 70^\circ\text{C}$	1.3		
Single Pulse Avalanche Energy	$E_{AS}$	82	140	mJ	
Avalanche Current	$I_{AR}$	4.0	-2.8	A	
Repetitive Avalanche Energy	$E_{AR}$	0.20		mJ	
Peak Diode Recovery $dv/dt$ <sup>③</sup>	$dv/dt$	5.0	-5.0	V/ ns	
Junction and Storage Temperature Range	$T_J, T_{STG}$	-55 to + 150 °C			

## Thermal Resistance Ratings

Parameter	Symbol	Limit	Units
Maximum Junction-to-Ambient <sup>④</sup>	$R_{\theta JA}$	62.5	$^\circ\text{C/W}$

# IRF7319PbF

International  
**IR** Rectifier

## Electrical Characteristics @ T<sub>J</sub> = 25°C (unless otherwise specified)

Parameter	Min.	Typ.	Max.	Units	Conditions
V <sub>(BR)DSS</sub>	30	—	—	V	V <sub>GS</sub> = 0V, I <sub>D</sub> = 250μA
ΔV <sub>(BR)DSS</sub> /ΔT <sub>J</sub>	-30	—	—	V/°C	V <sub>GS</sub> = 0V, I <sub>D</sub> = -250μA
R <sub>DS(ON)</sub>	0.022	0.029	—	Ω	Reference to 25°C, I <sub>D</sub> = 1mA
	0.022	0.046	—		Reference to 25°C, I <sub>D</sub> = -1mA
V <sub>GS(th)</sub>	1.0	—	—	V	V <sub>DS</sub> = 10V, I <sub>D</sub> = 5.8A ④
	-1.0	—	—		V <sub>DS</sub> = 4.5V, I <sub>D</sub> = 4.7A ④
g <sub>fs</sub>	14	—	—	S	V <sub>GS</sub> = -10V, I <sub>D</sub> = -4.9A ④
	7.7	—	—		V <sub>GS</sub> = -4.5V, I <sub>D</sub> = -3.6A ④
I <sub>DSS</sub>	—	—	1.0	μA	V <sub>DS</sub> = 24V, V <sub>GS</sub> = 0V
	—	—	-1.0		V <sub>DS</sub> = -24V, V <sub>GS</sub> = 0V
I <sub>GSS</sub>	—	—	25	nA	V <sub>DS</sub> = 24V, V <sub>GS</sub> = 0V, T <sub>J</sub> = 55°C
	—	—	-25		V <sub>DS</sub> = -24V, V <sub>GS</sub> = 0V, T <sub>J</sub> = 55°C
Q <sub>g</sub>	—	22	33	nC	V <sub>GS</sub> = ±20V
Q <sub>gs</sub>	—	2.6	3.9		N-Channel I <sub>D</sub> = 5.8A, V <sub>DS</sub> = 15V, V <sub>GS</sub> = 10V ④
Q <sub>gd</sub>	—	3.8	5.7	nC	P-Channel I <sub>D</sub> = -4.9A, V <sub>DS</sub> = -15V, V <sub>GS</sub> = -10V ④
t <sub>d(on)</sub>	—	6.4	9.6		N-Channel V <sub>DD</sub> = 15V, I <sub>D</sub> = 1.0A, R <sub>G</sub> = 6.0Ω, R <sub>D</sub> = 15Ω ④
t <sub>r</sub>	—	5.9	8.9	ns	P-Channel V <sub>DD</sub> = -15V, I <sub>D</sub> = -1.0A, R <sub>G</sub> = 6.0Ω, R <sub>D</sub> = 15Ω ④
t <sub>d(off)</sub>	—	8.1	12		N-Channel V <sub>GS</sub> = 0V, V <sub>DS</sub> = 25V, f = 1.0MHz
t <sub>f</sub>	—	13	19	pF	P-Channel V <sub>GS</sub> = 0V, V <sub>DS</sub> = -25V, f = 1.0MHz
C <sub>iss</sub>	—	650	—		N-Channel T <sub>J</sub> = 25°C, I <sub>S</sub> = 1.7A, V <sub>GS</sub> = 0V ③
C <sub>oss</sub>	—	710	—	pF	T <sub>J</sub> = 25°C, I <sub>S</sub> = -1.7A, V <sub>GS</sub> = 0V ③
C <sub>rss</sub>	—	320	—		N-Channel T <sub>J</sub> = 25°C, I <sub>F</sub> = 1.7A, di/dt = 100A/μs ④
P-Channel	—	380	—	pF	P-Channel T <sub>J</sub> = 25°C, I <sub>F</sub> = -1.7A, di/dt = 100A/μs ④
	—	130	—		
P-Channel	—	180	—	pF	
	—	180	—		

## Source-Drain Ratings and Characteristics

Parameter	Min.	Typ.	Max.	Units	Conditions
I <sub>S</sub>	—	—	2.5	A	
I <sub>SM</sub>	—	—	-2.5		
V <sub>SD</sub>	—	0.78	1.0	V	T <sub>J</sub> = 25°C, I <sub>S</sub> = 1.7A, V <sub>GS</sub> = 0V ③
t <sub>rr</sub>	—	-0.78	-1.0		T <sub>J</sub> = 25°C, I <sub>S</sub> = -1.7A, V <sub>GS</sub> = 0V ③
Q <sub>rr</sub>	—	45	68	nC	N-Channel T <sub>J</sub> = 25°C, I <sub>F</sub> = 1.7A, di/dt = 100A/μs ④
	—	44	66		P-Channel T <sub>J</sub> = 25°C, I <sub>F</sub> = -1.7A, di/dt = 100A/μs ④
	—	58	87		
	—	42	63		

### Notes:

- ① Repetitive rating; pulse width limited by max. junction temperature. ( See fig. 22 )
- ② N-Channel I<sub>SD</sub> ≤ 4.0A, di/dt ≤ 74A/μs, V<sub>DD</sub> ≤ V<sub>(BR)DSS</sub>, T<sub>J</sub> ≤ 150°C  
P-Channel I<sub>SD</sub> ≤ -2.8A, di/dt ≤ 150A/μs, V<sub>DD</sub> ≤ V<sub>(BR)DSS</sub>, T<sub>J</sub> ≤ 150°C
- ③ N-Channel Starting T<sub>J</sub> = 25°C, L = 10mH R<sub>G</sub> = 25Ω, I<sub>AS</sub> = 4.0A. (See Figure 12)  
P-Channel Starting T<sub>J</sub> = 25°C, L = 35mH R<sub>G</sub> = 25Ω, I<sub>AS</sub> = -2.8A.
- ④ Pulse width ≤ 300μs; duty cycle ≤ 2%.
- ⑤ Surface mounted on FR-4 board, t ≤ 10sec.

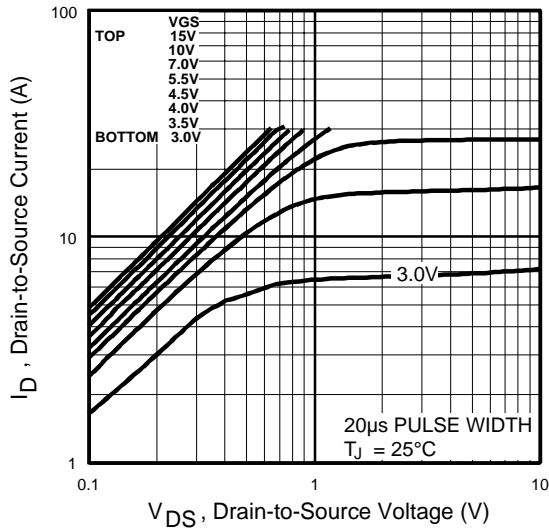

**Fig 1.** Typical Output Characteristics

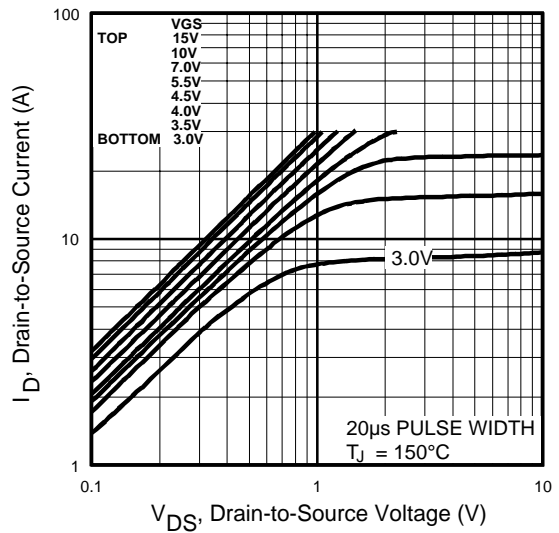

**Fig 2.** Typical Output Characteristics

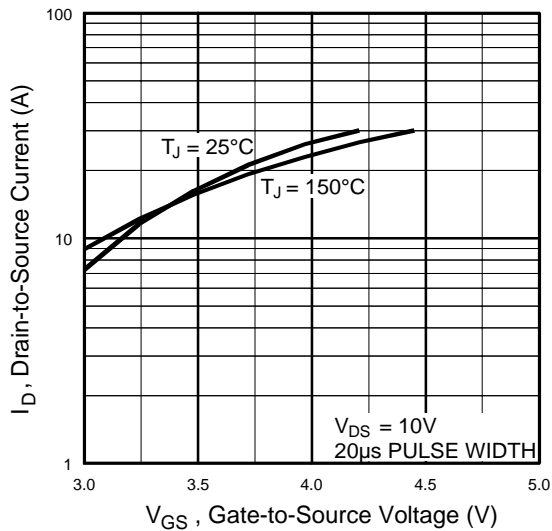

**Fig 3.** Typical Transfer Characteristics

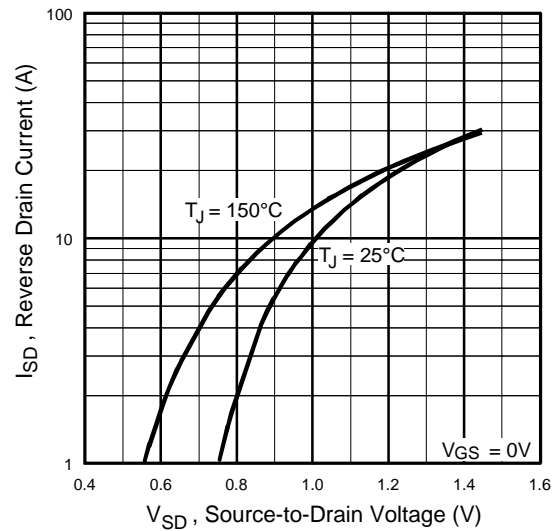
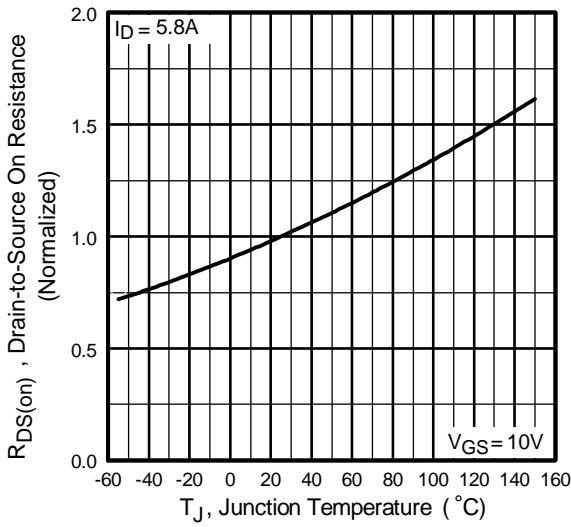

**Fig 4.** Typical Source-Drain Diode Forward Voltage

# IRF7319PbF

N-Channel

International  
**IR** Rectifier



**Fig 5.** Normalized On-Resistance Vs. Temperature

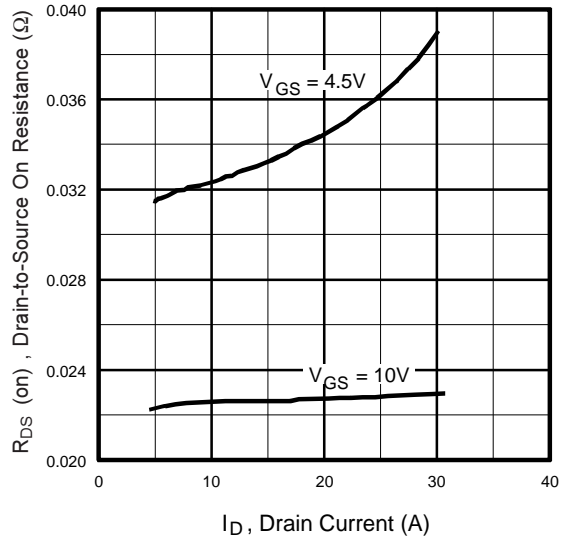

**Fig 6.** Typical On-Resistance Vs. Drain Current

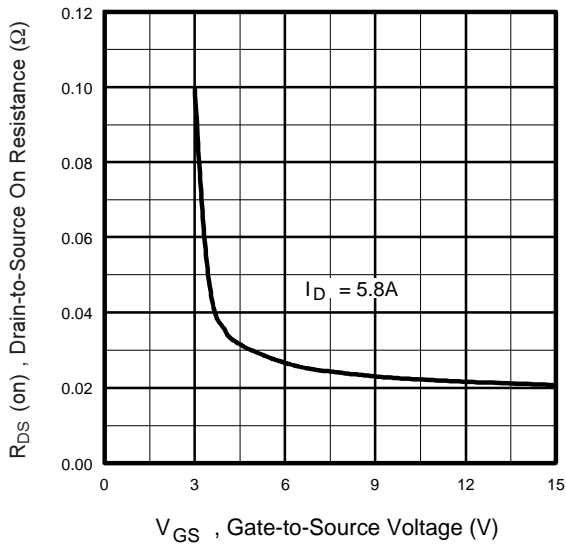

**Fig 7.** Typical On-Resistance Vs. Gate Voltage

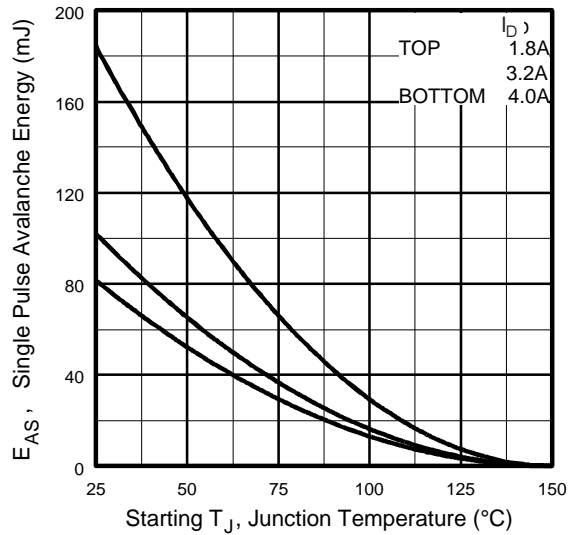

**Fig 8.** Maximum Avalanche Energy Vs. Drain Current

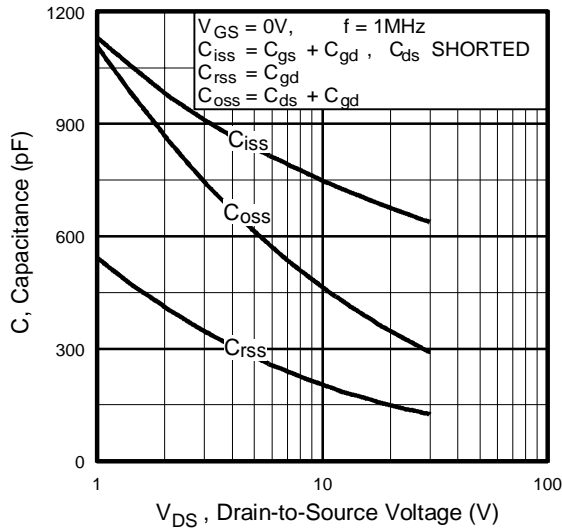

**Fig 9.** Typical Capacitance Vs. Drain-to-Source Voltage

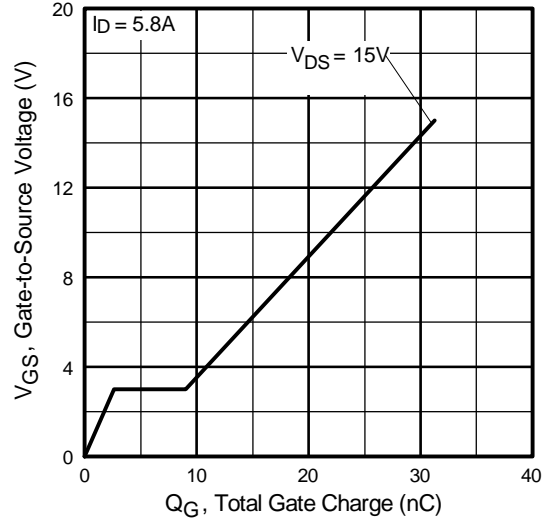

**Fig 10.** Typical Gate Charge Vs. Gate-to-Source Voltage

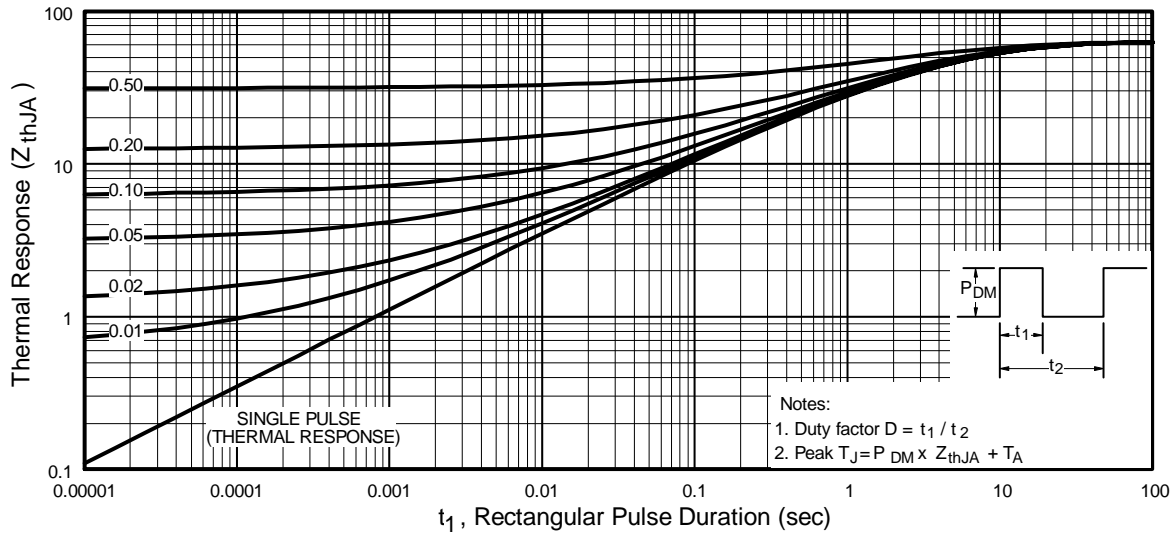

**Fig 11.** Maximum Effective Transient Thermal Impedance, Junction-to-Ambient

# IRF7319PbF

P-Channel

International  
**IR** Rectifier

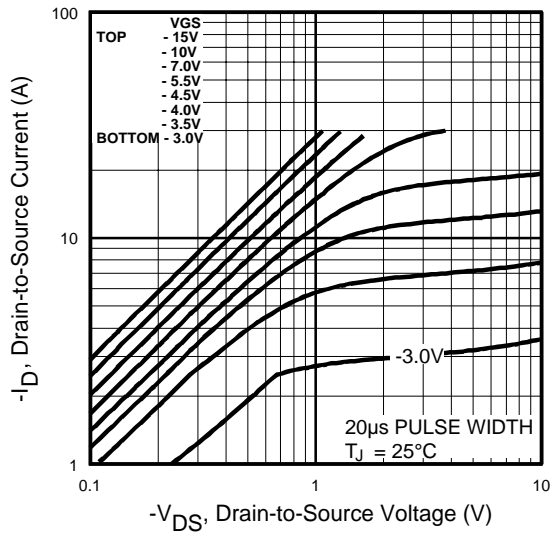

Fig 12. Typical Output Characteristics

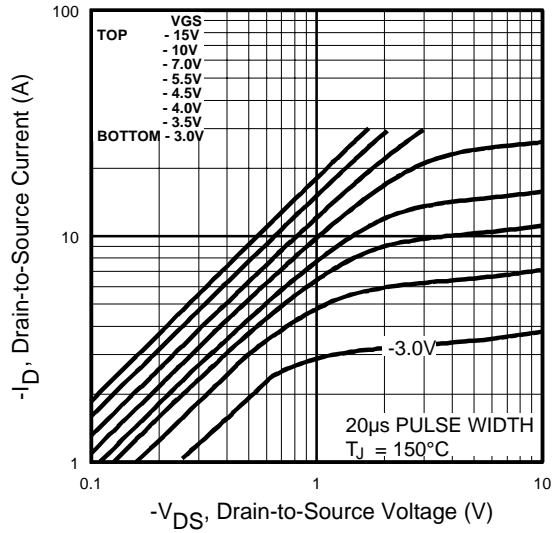

Fig 13. Typical Output Characteristics

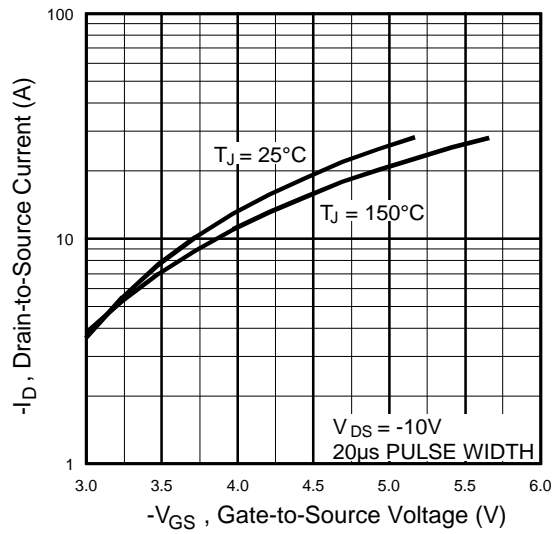

Fig 14. Typical Transfer Characteristics

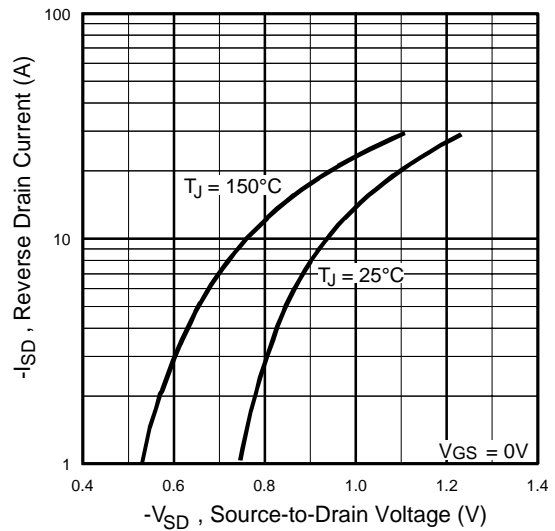
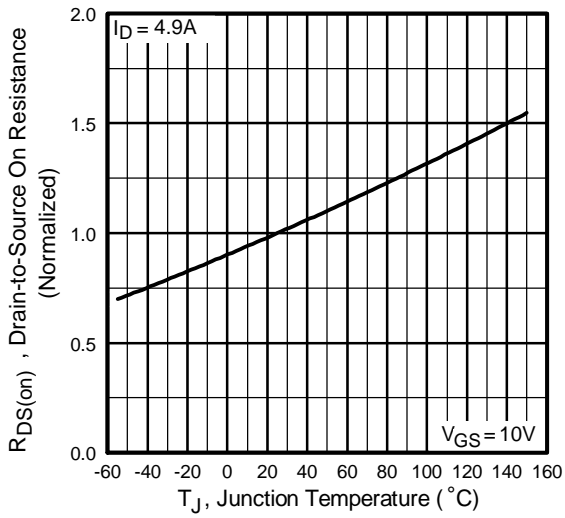
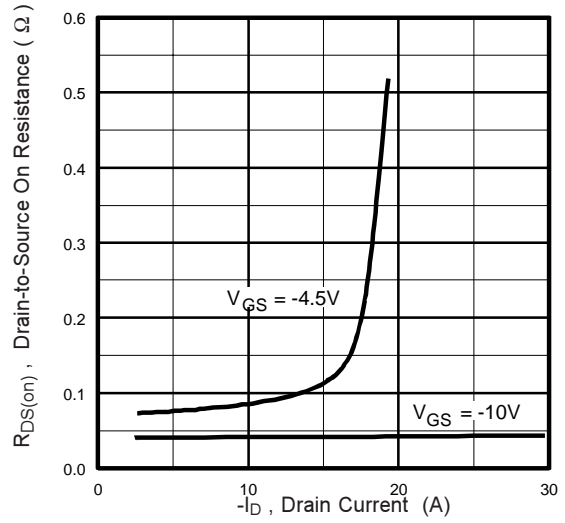

Fig 15. Typical Source-Drain Diode Forward Voltage



**Fig 16.** Normalized On-Resistance Vs. Temperature



**Fig 17.** Typical On-Resistance Vs. Drain Current

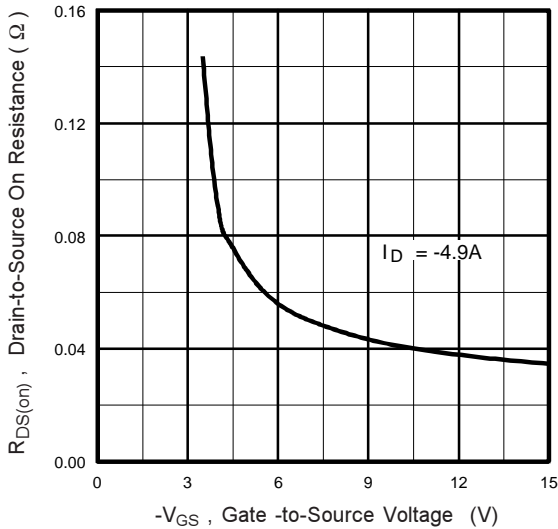

**Fig 18.** Typical On-Resistance Vs. Gate Voltage

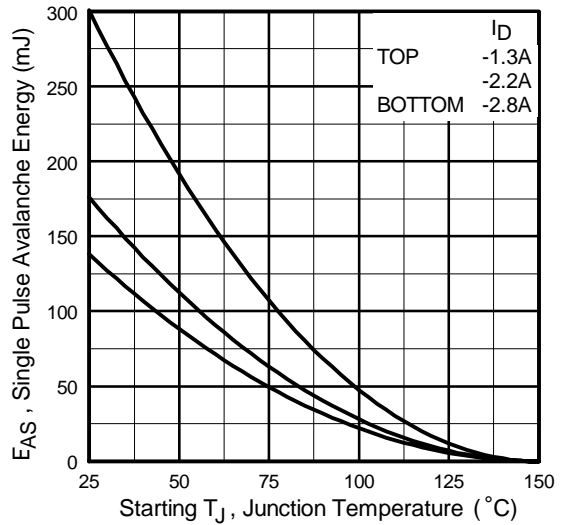
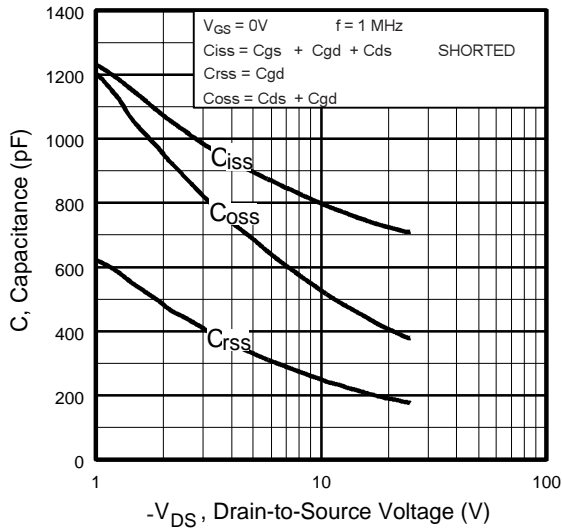

**Fig 19.** Maximum Avalanche Energy Vs. Drain Current

# IRF7319PbF

P-Channel

International  
**IR** Rectifier



**Fig 20.** Typical Capacitance Vs. Drain-to-Source Voltage

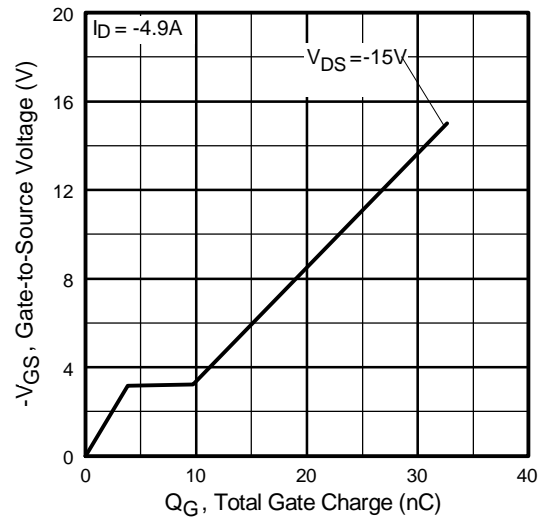

**Fig 21.** Typical Gate Charge Vs. Gate-to-Source Voltage

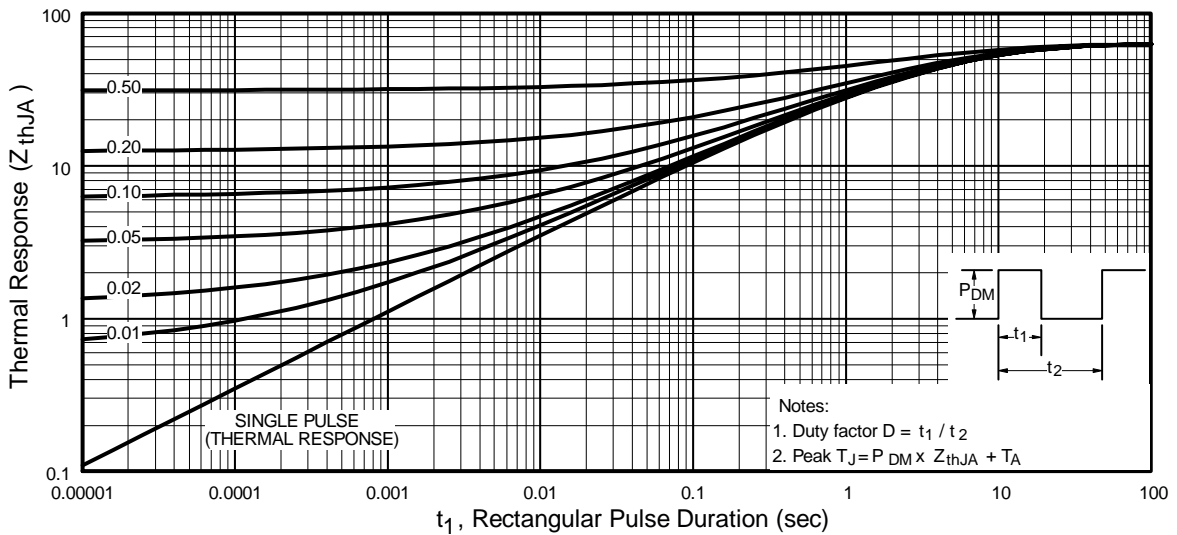
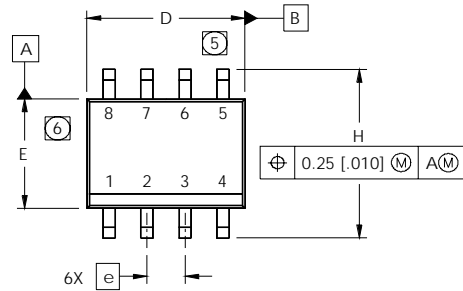

**Fig 22.** Maximum Effective Transient Thermal Impedance, Junction-to-Ambient



## SO-8 Package Outline

Dimensions are shown in millimeters (inches)



DIM	INCHES		MILLIMETERS	
	MIN	MAX	MIN	MAX
A	.0532	.0688	1.35	1.75
A1	.0040	.0098	0.10	0.25
b	.013	.020	0.33	0.51
c	.0075	.0098	0.19	0.25
D	.189	.1968	4.80	5.00
E	.1497	.1574	3.80	4.00
e	.050 BASIC		1.27 BASIC	
e1	.025 BASIC		0.635 BASIC	
H	.2284	.2440	5.80	6.20
K	.0099	.0196	0.25	0.50
L	.016	.050	0.40	1.27
y	0°	8°	0°	8°

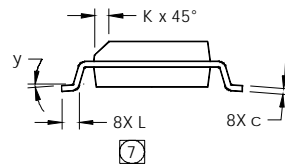
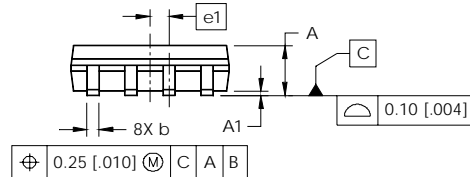

**NOTES:**

1. DIMENSIONING & TOLERANCING PER ASME Y14.5M-1994.
2. CONTROLLING DIMENSION: MILLIMETER
3. DIMENSIONS ARE SHOWN IN MILLIMETERS [INCHES].
4. OUTLINE CONFORMS TO JEDEC OUTLINE MS-012AA.
- ⑤ DIMENSION DOES NOT INCLUDE MOLD PROTRUSIONS. MOLD PROTRUSIONS NOT TO EXCEED 0.15 [.006].
- ⑥ DIMENSION DOES NOT INCLUDE MOLD PROTRUSIONS. MOLD PROTRUSIONS NOT TO EXCEED 0.25 [.010].
- ⑦ DIMENSION IS THE LENGTH OF LEAD FOR SOLDERING TO A SUBSTRATE.

**FOOTPRINT**

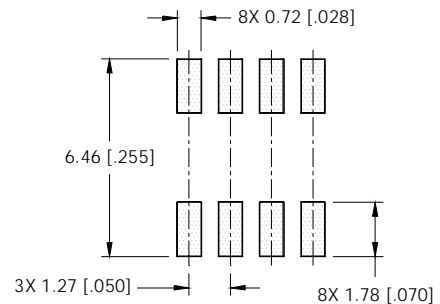

## SO-8 Part Marking

EXAMPLE: THIS IS AN IRF7101 (MOSFET)

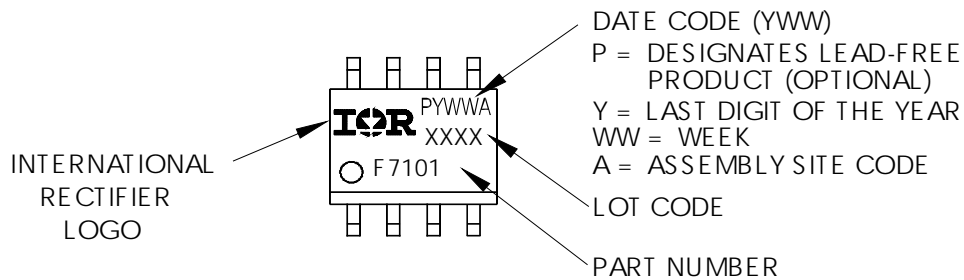

# IRF7319PbF

International  
**IR** Rectifier

## SO-8 Tape and Reel

Dimensions are shown in millimeters (inches)

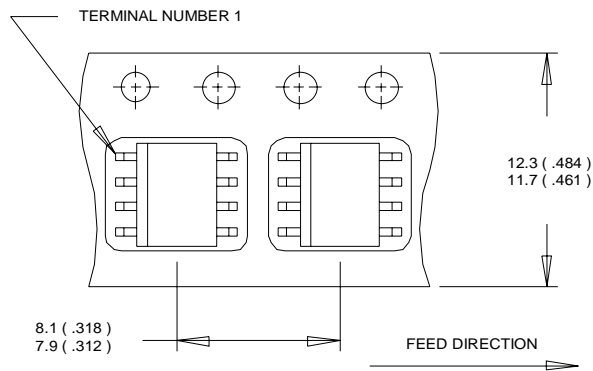

### NOTES:

1. CONTROLLING DIMENSION : MILLIMETER.
2. ALL DIMENSIONS ARE SHOWN IN MILLIMETERS(INCHES).
3. OUTLINE CONFORMS TO EIA-481 & EIA-541.

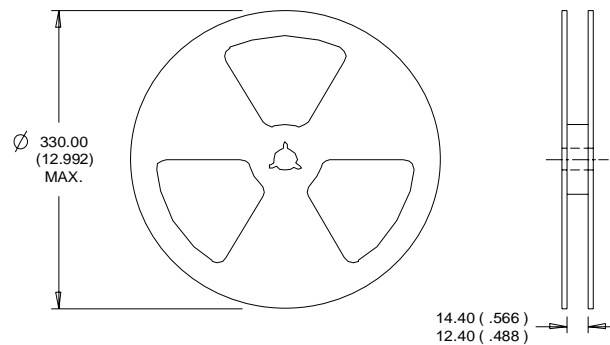

### NOTES:

1. CONTROLLING DIMENSION : MILLIMETER.
2. OUTLINE CONFORMS TO EIA-481 & EIA-541.

Data and specifications subject to change without notice.  
This product has been designed and qualified for the Consumer market.  
Qualifications Standards can be found on IR's Web site.

International  
**IR** Rectifier

IR WORLD HEADQUARTERS: 233 Kansas St., El Segundo, California 90245, USA Tel: (310) 252-7105  
TAC Fax: (310) 252-7903  
Visit us at [www.irf.com](http://www.irf.com) for sales contact information.08/04

## **IMPORTANT NOTICE**

The information given in this document shall in no event be regarded as a guarantee of conditions or characteristics ("Beschaffheitsgarantie").

With respect to any examples, hints or any typical values stated herein and/or any information regarding the application of the product, Infineon Technologies hereby disclaims any and all warranties and liabilities of any kind, including without limitation warranties of non-infringement of intellectual property rights of any third party.

In addition, any information given in this document is subject to customer's compliance with its obligations stated in this document and any applicable legal requirements, norms and standards concerning customer's products and any use of the product of Infineon Technologies in customer's applications.

The data contained in this document is exclusively intended for technically trained staff. It is the responsibility of customer's technical departments to evaluate the suitability of the product for the intended application and the completeness of the product information given in this document with respect to such application.

For further information on the product, technology, delivery terms and conditions and prices please contact your nearest Infineon Technologies office ([www.infineon.com](http://www.infineon.com)).

## **WARNINGS**

Due to technical requirements products may contain dangerous substances. For information on the types in question please contact your nearest Infineon Technologies office.

Except as otherwise explicitly approved by Infineon Technologies in a written document signed by authorized representatives of Infineon Technologies, Infineon Technologies' products may not be used in any applications where a failure of the product or any consequences of the use thereof can reasonably be expected to result in personal injury.