



CXA1191

LINEAR INTEGRATED CIRCUIT

FM/AM Radio

DESCRIPTION

The UTC **CXA1191** is a one-chip FM/AM radio IC designed for radio-cassette tape recorders and headphone tape recorders.

FEATURES

- *Small number of peripheral components
- *Low current consumption ($V_{CC}=3V$)
 - FM: $I_D=5.3mA$ (Typ.)
 - AM: $I_D=3.4mA$ (Typ.)
- *Built-in FM/AM select switch
- *Large current of AF amplifier

FUNCTIONS

FM section

- RF amplifier, Mixer and OSC
(incorporating AFC variable capacitor)
- IF amplifier
- Quadrature detection
- Tuning LED driver

AM section

- RF amplifier, Mixer and OSC (with RF AGC)
- IF amplifier (with IF AGC)
- Detector
- Tuning LED driver

AF section

- Electronic volume control
- FM muting

Structure

- Bipolar silicon monolithic IC

ORDERING INFORMATION

Ordering Number	Package	Packing
CXA1191G-D28-T	DIP-28	Tube
CXA1191G-S28-R	SOP-28	Tape Reel
CXA1191G-S28-T	SOP-28	Tube

<p>CXA1191G-D28-R</p> <p>(1) Packing Type (2) Package Type (3) Green Package</p>	<p>(1) R: Tape Reel, T: Tube (2) D28: DIP-28, S28: SOP-28 (3) G: Halogen Free and Lead Free</p>
--	---

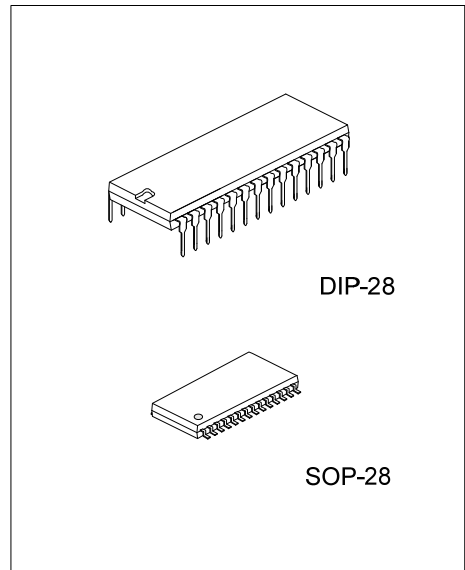

CXA1191

LINEAR INTEGRATED CIRCUIT

MARKING

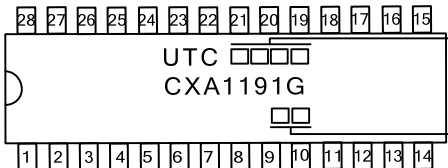
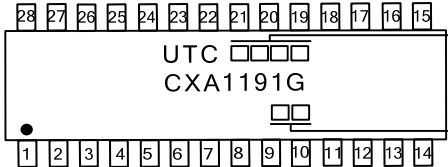
PACKAGE	MARKING
DIP-28	 <p>The diagram shows a top-down view of a DIP-28 package. The top edge is labeled with pins 28 to 15, and the bottom edge with pins 1 to 14. A central rectangular area contains the marking: 'UTC' followed by four small squares, 'CXA1191G', and two more small squares. An arrow on the right points from the top four squares to the text 'Date Code'. Another arrow on the right points from the bottom two squares to the text 'Lot Code'.</p>
SOP-28	 <p>The diagram shows a top-down view of an SOP-28 package. The top edge is labeled with pins 28 to 15, and the bottom edge with pins 1 to 14. A central rectangular area contains the marking: 'UTC' followed by four small squares, 'CXA1191G', and two more small squares. An arrow on the right points from the top four squares to the text 'Date Code'. Another arrow on the right points from the bottom two squares to the text 'Lot Code'.</p>

■ PIN CONFIGURATIONS

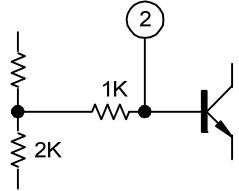
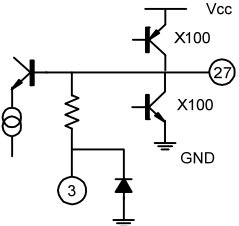
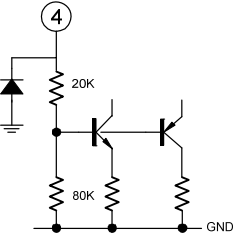
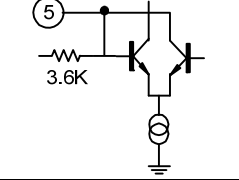
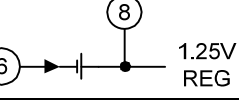
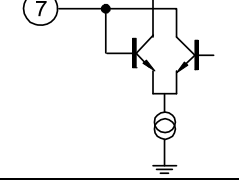
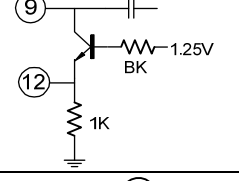
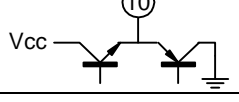
PIN	DESCRIPTION	SYMBOL	VOLTAGE(V)				EQUIVALENT CIRCUIT
			V _{CC} =3V		V _{CC} =6V		
			FM	AM	FM	AM	
1		MUTE	0	0	0	0	
2	Phase-shift circuit, Connect ceramic discriminator.	FM DISCRI	2.18	2.7	4.88	5.43	
3	Negative feedback pin	NF	1.5	1.5	3.0	3.0	
27	Power amplifier output pin	AF OUT	1.5	1.5	3.0	3.0	
4	Connect variable resistor for electronic volume control.	VOL CONT	1.25	1.25	1.25	1.25	
5	AM local oscillation circuit	AM OSC	1.25	1.25	1.25	1.25	
6	AFC variable capacitor pin	AFC	1.25	Note	1.25	Note	
8	Regulator pin 1.25V (Typ.)	REG OUT	1.25	1.25	1.25	1.25	
7	FM local oscillation circuit	FM OSC	1.25	1.25	1.25	1.25	
9	Connect FM RF tuning coil.	FM RF	1.25	1.25	1.25	1.25	
12	FM RF input pin	FM RF IN	0.3	0	0.3	0	
10	AM RF input	AM RF IN	1.25	1.25	1.25	1.25	
11		NC	0	0	0	0	
13		GND (FE GND)	0	0	0	0	

■ PIN CONFIGURATIONS(Cont.)

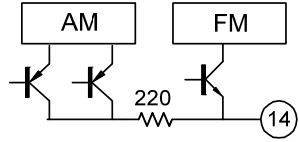
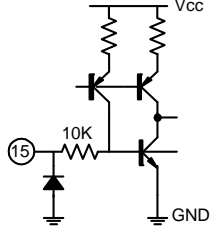
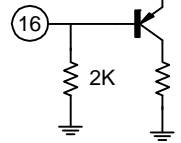
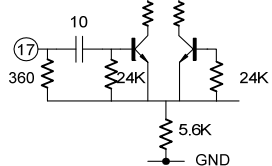
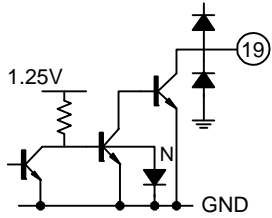
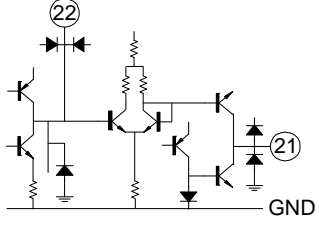
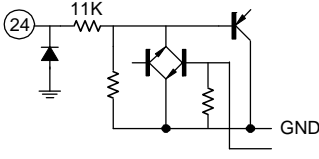
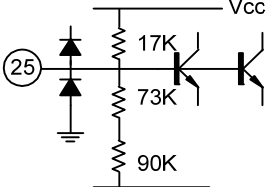
PIN	DESCRIPTION	SYMBOL	VOLTAGE(V)				EQUIVALENT CIRCUIT
			V _{CC} =3V		V _{CC} =6V		
			FM	AM	FM	AM	
14	IF output pin of FM and AM, Connect IF filter	FM/AM FE OUT	0.36	0.2	0.36	0.2	
15	FM and AM bands selection switch pin. During GND it becomes AM and during open it becomes FM.	BAND SELECT	0.84	0	0.88	0	
16	Input pin of AM IF	AM IF IN	0	0	0	0	
17	Input pin of FM IF	FM IF IN	0.34	0	0.88	0	
18		NC	0	0	0	0	
19	Meter drive circuit (For tuning indicator)	METER	1.6	1.6	4.5	4.5	
20		GND	0	0	0	0	
21	AFC pin of W band. During AM, it determines time constant of AGC.	AFC/AGC	1.25	1.49	1.25	1.49	
22	AFC pin of J band. During AM, it determines time constant of AGC.	AFC/AGC	1.25	1.25	1.25	1.25	
23	Detection output pin	DET OUT	1.25	1.0	1.25	1.0	
24	Power amplifier input pin	AF IN	0	0	0	0	
25	Ripple filter	RIPPLE FILTER	2.71	2.71	5.4	5.4	

■ PIN CONFIGURATIONS(Cont.)

PIN	DESCRIPTION	SYMBOL	VOLTAGE(V)				EQUIVALENT CIRCUIT
			V _{CC} =3V		V _{CC} =6V		
			FM	AM	FM	AM	
6	Power supply pin	V _{CC}	3.0	3.0	6.0	6.0	
28	Power GND	GND	0	0	0	0	

Note: The pin voltage of pin 6 during AM, it is the same pin voltage of pin22 (23) during J BAND and is the same pin voltage of pin 21 (22) during W BAND.

■ BLOCK DIAGRAM

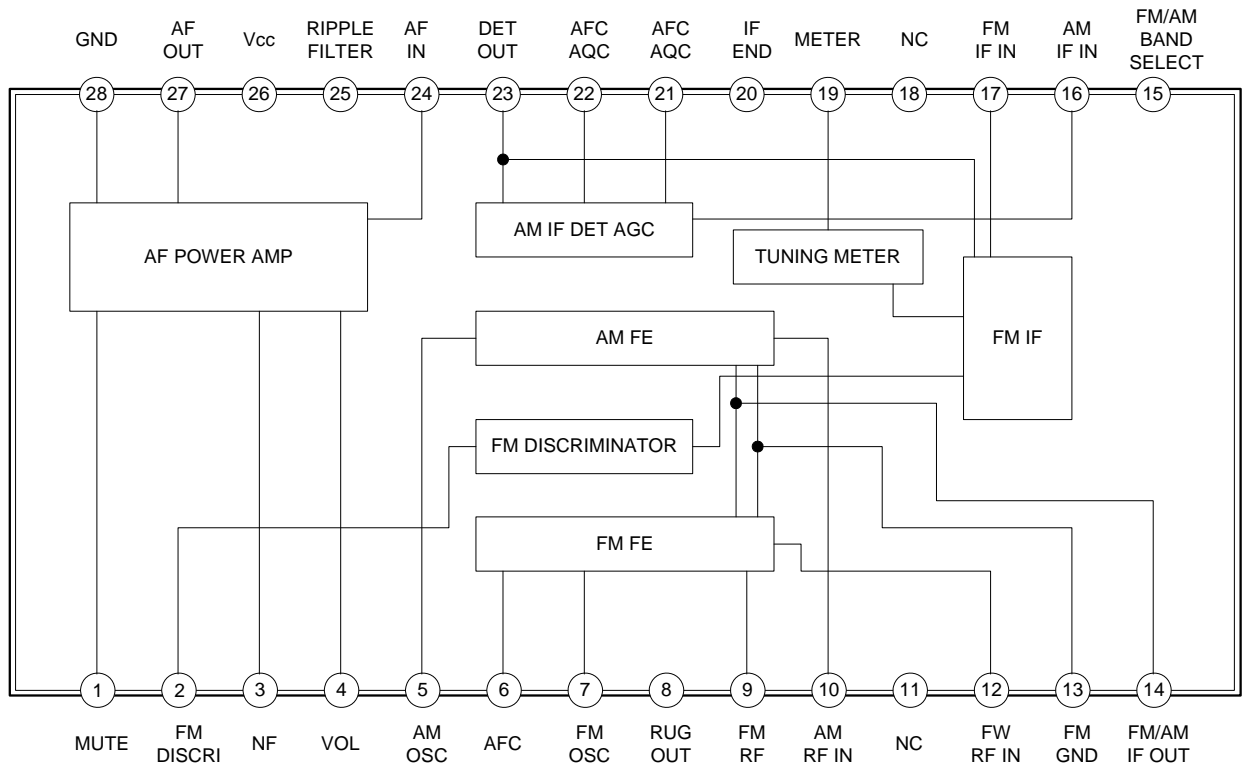

■ ABSOLUTE MAXIMUM RATINGS (T_a =25°C)

PARAMETER	SYMBOL	RATINGS	UNIT
Supply Voltage	V _{CC}	9	V
Power Dissipation	DIP-28	1000	mW
	SOP-28	700	mW
Junction Temperature	T _J	+150	°C
Operating Temperature	T _{OPR}	0 ~ +70	°C
Storage Temperature	T _{STG}	-40 ~ +150	°C

Note: Absolute maximum ratings are those values beyond which the device could be permanently damaged.

Absolute maximum ratings are stress ratings only and functional device operation is not implied.

■ RECOMMENDED OPERATING CONDITIONS

PARAMETER	SYMBOL	RATINGS	UNIT
Supply Voltage	DIP-28	2 ~ 8.5	V
	SOP-28	2 ~ 7.5	V

■ ELECTRICAL CHARACTERISTICS (T_a=25°C, V_{CC}=6V)

PARAMETER	SYMBOL	SW CONDITIONS						TEST POINT	CONDITIONS	MIN	TYP	MAX	UNIT
		1	2	3	4	5	6						
AM Circuit Current	I _{D1}	A	B	A	A	A	A	I _A	No signal, AM	-	3.5	10.0	mA
FM Circuit Current	I _{D2}	A	B	A	A	B	A	I _A	No signal, FM	-	7.0	14.0	mA
FM Front End Voltage Gain	G _{V1}	A	B	A	A	B	A	V _A	V _{IN1} =40dBμV, 100MHz	32	39	46	dB
FM Detection Output Level	V _{D1}	A	-	-	A	B	A	V _D	V _{IN3} =90dBμV, 10.7 MHz (1 kHz, 22.5kHz DEV)	39	77.5	155	V _{rms}
FM IF Knee Level	V _{D2}	A	-	-	A	B	A	V _D	V _{IN3} level at a point 3 dB down from V _{IN3} =90dBμV, 10.7 MHz (1 kHz, 22.5kHz DEV)	-	24	32	dBμV
FM Detection Output Distortion Factor	THD1	A	-	-	A	B	A	V _D	V _{IN3} =90dBμV, 10.7 MHz (1 kHz, 75kHz DEV)	-	0.3	2.0	%
FM Meter Current	I _{B1}	A	-	-	A	B	A	I _M	V _{IN3} =60dBμV, 10.7 MHz	1.8	3.5	7.0	mA
AM Front End Voltage Gain	G _{V2}	A	A	A	A	A	A	V _B	V _{IN3} =60dBμV, 1660 kHz	15	22	29	dB
AM IF Voltage Gain	G _{V3}	A	A	-	A	A	A	V _D	V _{IN3} w hen 455kHz (1kHz, 30% MOD) output is - 34dBm	14	20	27	dBμV
AM Detection Output Level	V _{D3}	A	A	-	A	A	A	V _D	V _{IN3} =85dBμV, 455kHz (1kHz, 30% MOD)	39	77.5	155	V _{rms}
AM Meter Current	I _{B2}	A	A	-	A	A	A	I _M	V _{IN3} =85dBμV, 455kHz (1kHz, 30% MOD)	1.3	3.0	7.0	mA
AM Detection Output Distortion Factor	THD2	A	A	B	B	A	A	V _D	V _{IN2} =60dBμV, 1660kHz (1kHz, 30% MOD), V _{CC} =7.8V	-	0.6	2.0	%
Audio Voltage Gain	G _{V4}	A	-	-	-	-	B	V _E	V _{IN3} =60dBμV, 10.7MHz V _{IN4} =-30dBμV, 1kHz	27	31.5	36	dB
Audio Distortion Factor	THD3	A	-	-	-	-	B	V _E	Distortion factor for output of 50mV V _{IN3} =60dBμV, 10.7MHz V _{IN4} =-20dBμ m, 1kHz	-	0.3	2.5	%
Muting Level	V _{D4}	A	-	-	-	-	B	V _E	Muting level for 50 mW output V _{IN4} =-20dBm, 1kHz V _{IN3} OFF	8	15	22	dB

0dBμV=1μV

APPLICATION CIRCUIT

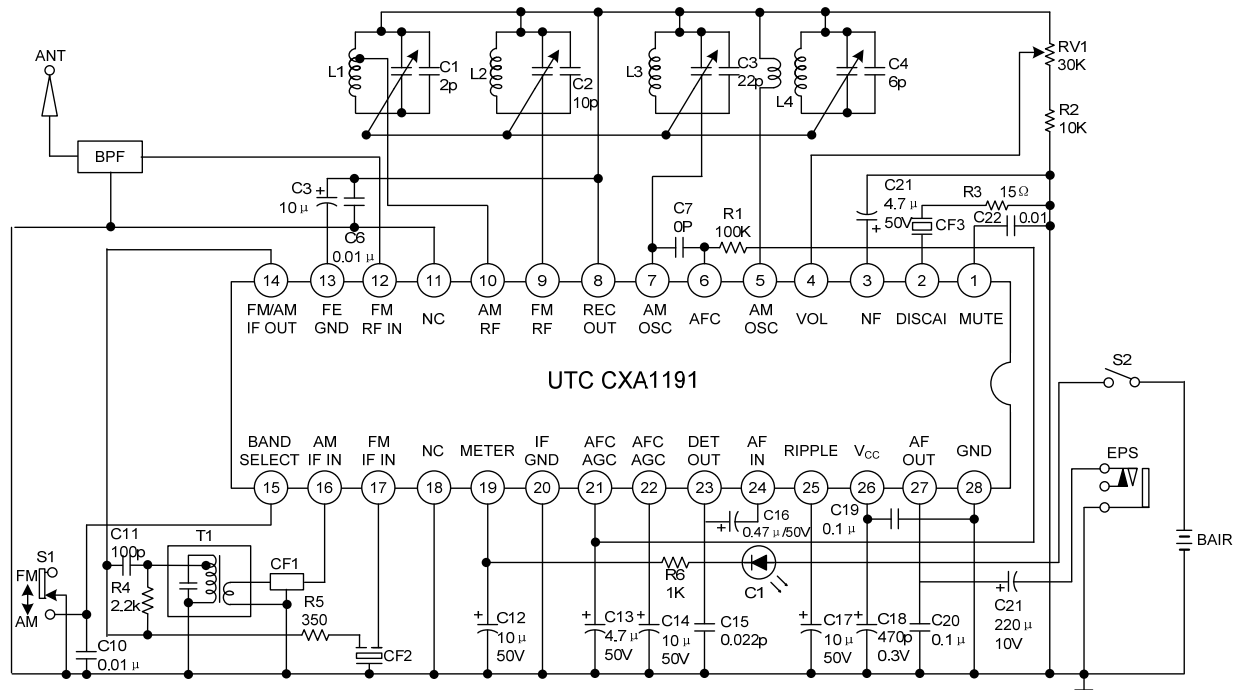

UTC assumes no responsibility for equipment failures that result from using products at values that exceed, even momentarily, rated values (such as maximum ratings, operating condition ranges, or other parameters) listed in products specifications of any and all UTC products described or contained herein. UTC products are not designed for use in life support appliances, devices or systems where malfunction of these products can be reasonably expected to result in personal injury. Reproduction in whole or in part is prohibited without the prior written consent of the copyright owner. The information presented in this document does not form part of any quotation or contract, is believed to be accurate and reliable and may be changed without notice.