

3-phase motor driver for CD-ROMs

BA6849FP / BA6849FP-Y / BA6849FM / BA6849FS

The BA6849 series are ICs developed for CD-ROM spindle motor drives. These ICs possess a short brake and reverse-rotation brake for two types of brake functions, and also contain FG output and rotation direction detection (FR) circuits, making them high-functionality and high-performance ICs.

●Applications

CD-ROM, CD-R, CD-RW, DVD-ROM, and DVD-RAM

●Features

- 1) Three-phase, full-wave, pseudo-linear drive system.
- 2) Built-in power save and thermal shutdown functions.
- 3) Built-in current limiter and Hall bias circuits.
- 4) Built-in FG output.
- 5) Built-in rotation direction detector.
- 6) Built-in reverse rotation prevention circuit.
- 7) Built-in short brake pin.

●Absolute maximum ratings (Ta = 25°C)

Parameter		Symbol	Limits	Unit
Applied voltage (with 5V power supply)		V _{CC}	7	V
Applied voltage (motor power supply1)		V _{M1}	16	V
Applied voltage (motor power supply2)		V _{M2}	16	V
Power dissipation	BA6849FM	P _d	2200*1	mW
	BA6849FP		1700*2	mW
	BA6849FP-Y		1450*3	mW
	BA6849FS		1000*4	mW
Operating temperature		T _{opr}	-20~+75	°C
Storage temperature		T _{stg}	-55~+150*5	°C
Output current		I _{OUT}	1300*6	mA

*1 Reduced by 17.6mW for each increase in Ta of 1°C over 25°C.

*2 When mounted on a 70mm×70mm×1.6mm glass epoxy board.

Reduced by 13.6mW for each increase in Ta of 1°C over 25°C.

*3 Reduced by 11.6mW for each increase in Ta of 1°C over 25°C.

*4 Reduced by 8.0mW for each increase in Ta of 1°C over 25°C.

*5 T_j should not exceed 150°C.

*6 Should not exceed P_d or ASO values.

● Pin descriptions

BA6849FP/BA6849FM

Pin No.	Pin Name	Function
2	A ₃	Output
4	A ₂	Output
7	A ₁	Output
8	GND	GND
9	H ₁ ⁺	Hall signal input
10	H ₁ ⁻	Hall signal input
11	H ₂ ⁺	Hall signal input
12	H ₂ ⁻	Hall signal input
13	H ₃ ⁺	Hall signal input
14	H ₃ ⁻	Hall signal input
15	V _H	Hall bias
17	C _{NF}	For connection of phase compensation capacitor
18	SB	Short brake
20	FR	Rotation direction detection
21	E _{CR}	Output voltage control reference
22	E _C	Output voltage control
23	PS	Power save
24	FG	FG signal output
25	V _{CC}	Power supply
26	V _{M2}	Motor power supply 2
27	V _{M1}	Motor power supply 1
28	R _{NF}	For connection of output current detection resistor
FIN	—	SUB GND

* * Missing pin numbers are N.C.

BA6849FP-Y

Pin No.	Pin name	Function
1	—	SUB GND
2	A ₃	Output
3	A ₂	Output
5	A ₁	Output
6	GND	GND
7	H ₁ ⁺	Hall signal input
8	H ₁ ⁻	Hall signal input
9	H ₂ ⁺	Hall signal input
10	H ₂ ⁻	Hall signal input
11	H ₃ ⁺	Hall signal input
12	H ₃ ⁻	Hall signal input
13	V _H	Hall bias
15	C _{NF}	For connection of phase compensation capacitor
16	SB	Short brake
17	FR	Rotation direction detection
18	E _{CR}	Torque control reference
19	E _C	Torque control
20	PS	Power save
21	FG	FG signal output
22	V _{CC}	Power supply
23*	V _{M2}	Motor power supply 2
23*	V _{M1}	Motor power supply 1
24	R _{NF}	For connection of output current detection resistor

* Connected within the IC.

Note) Missing pin numbers are N.C.

MA6849FS

Pin No.	Pin name	Function
1	—	SUB GND
2	A ₃	Output
3	A ₂	Output
5	A ₁	Output
6	GND	GND
7	H ₁ ⁺	Hall signal input
8	H ₁ ⁻	Hall signal input
9	H ₂ ⁺	Hall signal input
10	H ₂ ⁻	Hall signal input
11	H ₃ ⁺	Hall signal input
12	H ₃ ⁻	Hall signal input
13	V _H	Hall bias
15	C _{NF}	For connection of phase compensation capacitor
16	SB	Short brake
17	FR	Rotation direction detection
18	E _{CR}	Torque control reference
19	E _C	Torque control
20	PS	Power save
21	FG	FG signal output
22	V _{CC}	Power supply
23*	V _{M2}	Motor power supply 2
23*	V _{M1}	Motor power supply 1
24	R _{NF}	For connection of output current detection resistor

* Connected within the IC.

Note) Missing pin numbers are N.C.

● Input / output circuits

(1) Power save

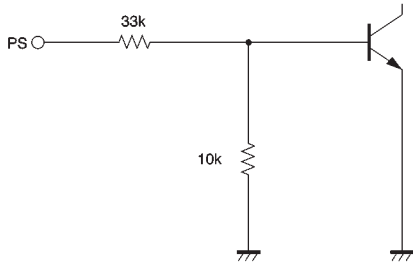

Fig.1

(2) Torque command input

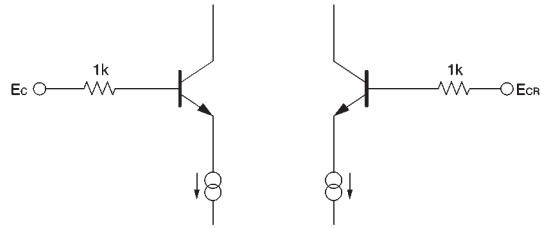

Fig.2

(3) Torque output (A_1 , A_2 , and A_3)

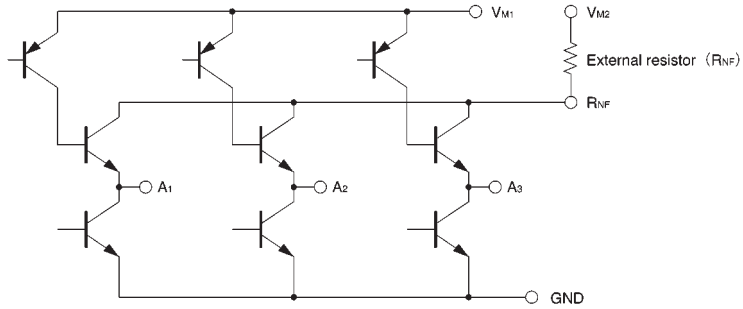

Fig.3

(4) Hall input (H_1^+ , H_1^- , H_2^+ , H_2^- , H_3^+ , H_3^-)

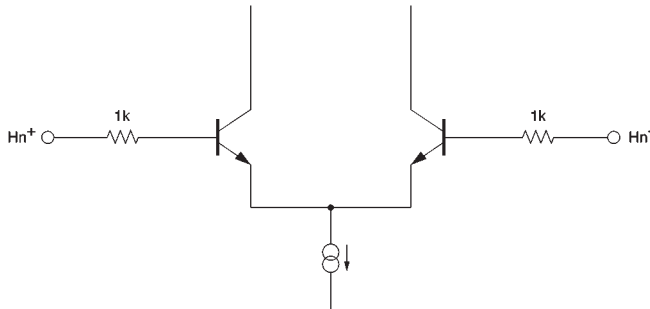

Fig.4

Note: Resistance values are typical values.

(5) Hall bias

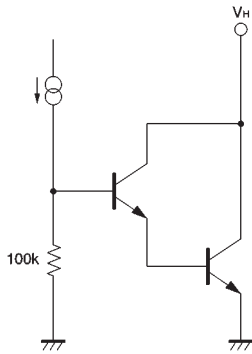

Fig.5

(7) FR Output

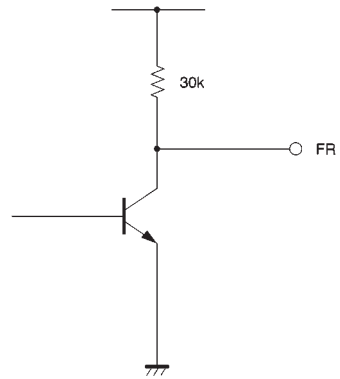

Fig.7

(6) FG output

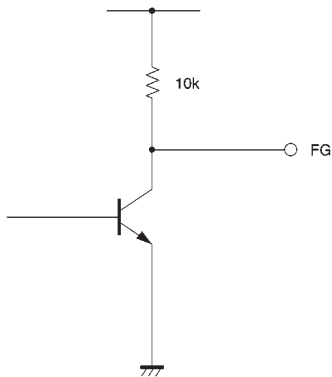

Fig.6

(8) Short brake

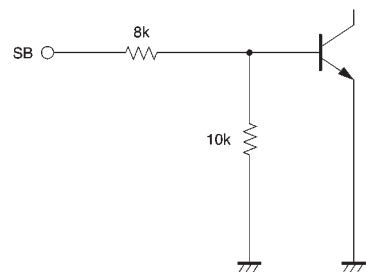

Fig.8

Note: Resistance values are typical values.

●Electrical characteristics (unless otherwise noted, $T_a = 25^\circ\text{C}$, $V_{CC} = 5\text{V}$, $V_{M1} = 12\text{V}$, $V_{M2} = 12\text{V}$)

Parameter	Symbol	Min.	Typ.	Max.	Unit	Coniditions
〈Total device〉						
Circuit current 1	I_{CC1}	—	0	0.2	mA	In the power save ON state
Circuit current 2	I_{CC2}	—	4.1	6.5	mA	In the power save OFF state
〈Power save〉						
ON voltage range	V_{PSON}	—	—	1.5	V	—
OFF voltage range	V_{PSOFF}	3.5	—	—	V	—
〈Hall bias〉						
Hall bias voltage	V_{HB}	0.5	0.9	1.5	V	$I_{HB}=10\text{mA}$
〈Hall amplifier〉						
Input bias current	I_{HA}	—	0.7	3.0	μA	—
Same phase input voltage range	V_{HAR}	1.5	—	4.0	V	—
Minimum input level	V_{INH}	50	—	—	mV _{P-P}	—
H3 hysteresis level	V_{HYS}	10	20	40	mV	—
〈Torque command〉						
Input voltage range	E_C	1.0	—	4.0	V	—
“—” offset voltage	E_{COFF-}	—80	—50	—20	mV	$E_{CR}=2.5\text{V}$
“+” offset voltage	E_{COFF+}	20	50	80	mV	$E_{CR}=2.5\text{V}$
Input bias current	E_{CIN}	—	0.5	2.0	μA	$E_C=E_{CR}$
I / O gain	G_{EC}	0.41	0.51	0.61	A / V	$E_C=1.5\text{V}, 2.0\text{V}$
〈FG〉						
FG output high level voltage	V_{FGH}	4.5	4.8	—	V	$I_{FG}=-20\mu\text{A}$
FG output low level voltage	V_{FGL}	0	0.25	0.4	V	$I_{FG}=3\text{mA}$
DUTY (reference value)	DU	—	50	—	%	—
〈Rotation detection〉						
FR output high level voltage	V_{FRH}	4.1	4.4	—	V	$I_{FR}=-20\mu\text{A}$
FR output low level voltage	V_{FRL}	0	0.25	0.4	V	$I_{FR}=3\text{mA}$
〈Output〉						
Output saturation high level voltage	V_{OH}	—	1.0	1.5	V	$I_o=-600\text{mA}$
Output saturation low level voltage	V_{OL}	—	0.4	0.8	V	$I_o=600\text{mA}$
Pre-drive current	I_{VML}	—	35	70	mA	$E_C=0\text{V}$ output open
Output limit current	I_{TL}	560	700	840	mA	—
〈Short brake〉						
ON voltage range	V_{SBON}	3.5	—	—	V	—
OFF voltage range	V_{SBOFF}	—	—	1.5	V	—

©Not designed for radiation resistance.

● Circuit operation

(1) Hall input to coil output

The phase relationship between the Hall input signals and the output current and voltage is shown in Fig.9. The motor position data input via the Hall pins is amplified by the Hall amplifier, and formed into waveforms by the matrix block. These signals are input to the output driver that supplies the drive current to the motor coils.

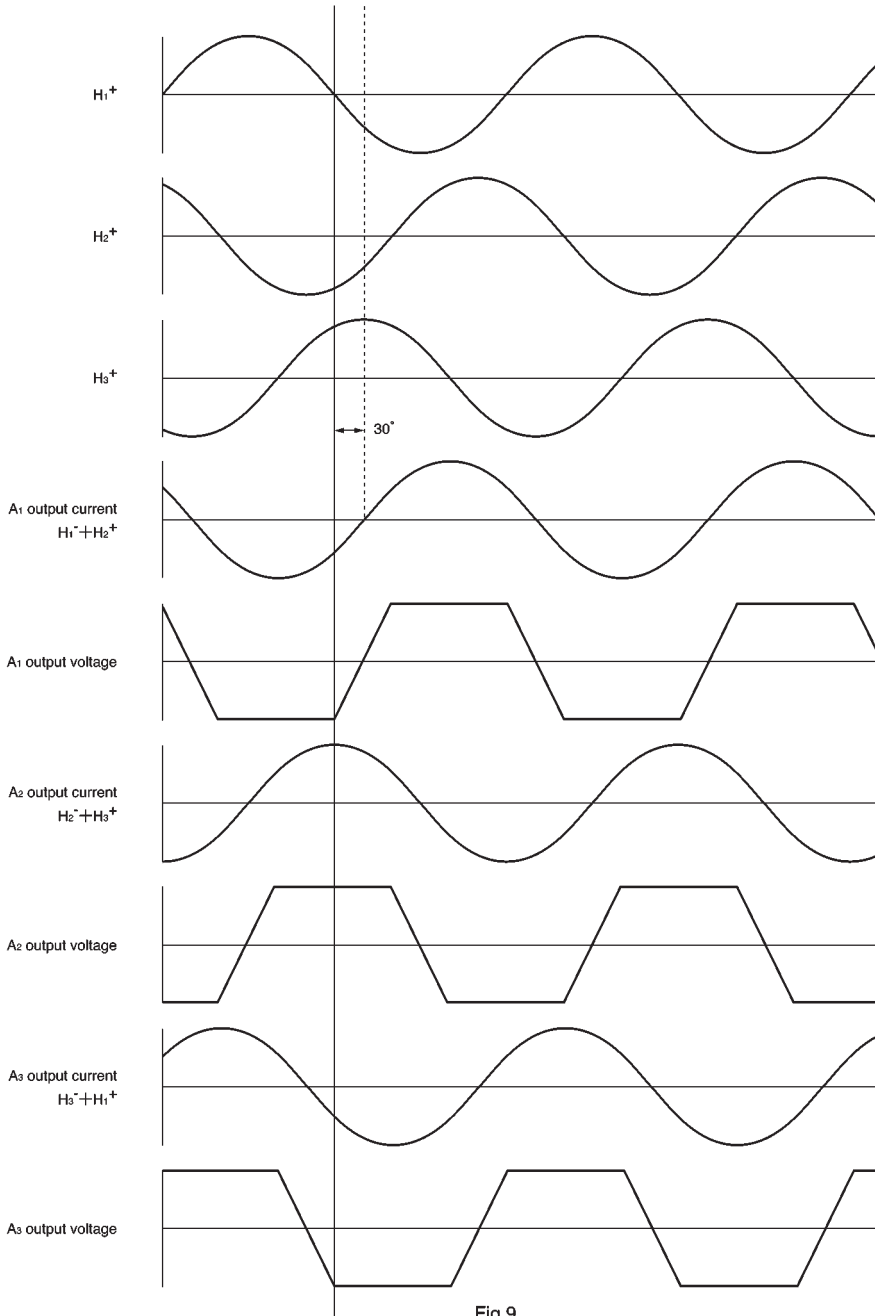

Fig.9

(2) Torque command

The R_{NF} pin voltage with respect to the torque command

(E_c) is as follows:

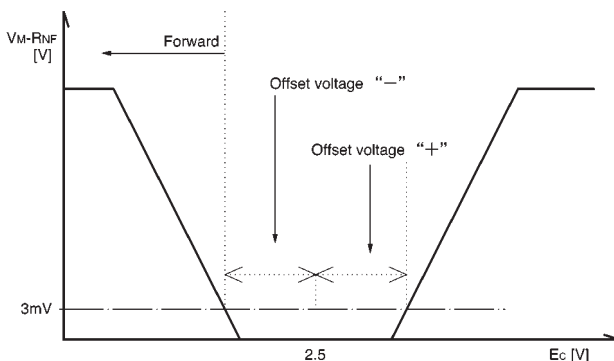

Fig.10

	Rotation direction
$E_c < E_{CR}$	Forward
$E_c > E_{CR}$	Reverse*

* Stops after detecting reverse.

The I / O gain (G_{EC}) from the E_c pin to the R_{NF} pin (output current) is determined by the R_{NF} detector resistor.

$$G_{EC} = 0.255 / R_{NF} [A / V]$$

The torque limit current I_{TL} is given by:

$$I_{TL} = 0.35 / R_{NF} [A]$$

(3) Reverse rotation detection function

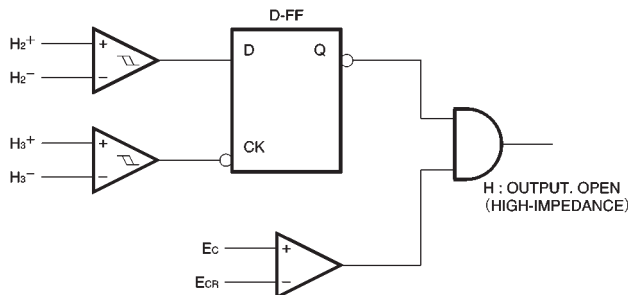

Fig.11

The reverse detection circuit construction is shown in Fig.11.

1) Forward ($E_c < E_{CR}$)

The phase relationship between the Hall input signals H_2^+ and H_3^+ becomes as shown in Fig.9, and the reverse rotation detection circuit does not operate.

2) Reverse ($E_c > E_{CR}$)

The phase relationship between the signals H_2^+ and H_3^+ is opposite that for forward operation, and the reverse rotation detection circuit operates. The output goes OFF, and becomes open circuit.

	FR signal output pin
Forward	L
Reverse	H

(4) Short brake

When 3.5V or more is applied to the short brake pin, the upper-side output transistors of all go off, and the lower-side output transistors go on. Short braking operates regardless of the torque command signal.

(5) Other circuits

When 3.5V or more is applied to the power save pin, all circuits are on. When 1.5V or less is applied, the IC enters power save mode. Also, the Hall bias pins turn on and off with the power save pin.

●Application example

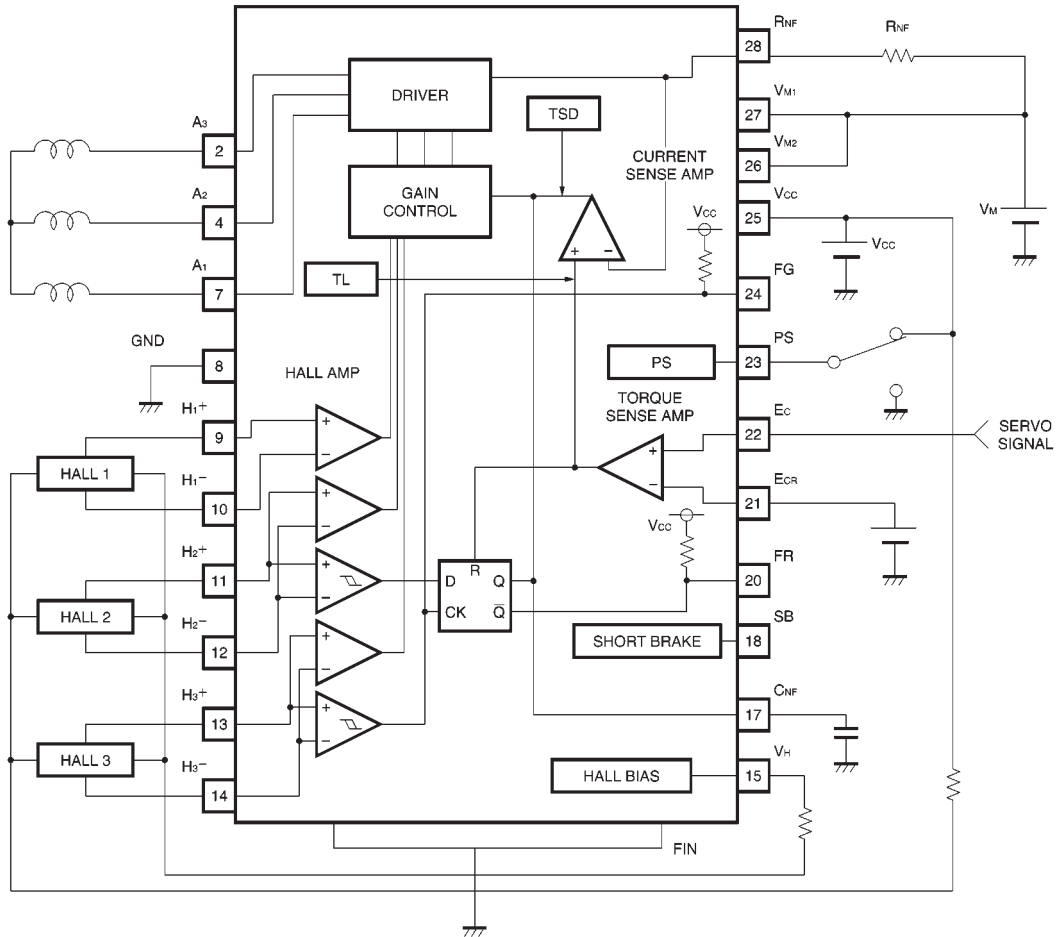

Fig.12

● Operation notes

(1) Power save

The power save input is an I/O circuit like the own shown in Fig.1.

The thermal derating characteristics of the power save pin is $-8\text{mV} / ^\circ\text{C}$, and the resistance will fluctuate between $\pm 30\%$ so be careful of the input voltage range.

(2) Hall input

The input circuit shown in Fig.4 is used for the Hall inputs. The Hall elements can be connected either in series or in parallel.

(3) Thermal shutdown (TSD)

When the junction temperature reaches 175°C , the A_1 , A_2 , and A_3 coil outputs go open circuit. The thermal shutdown has approximately 15°C of hysteresis.

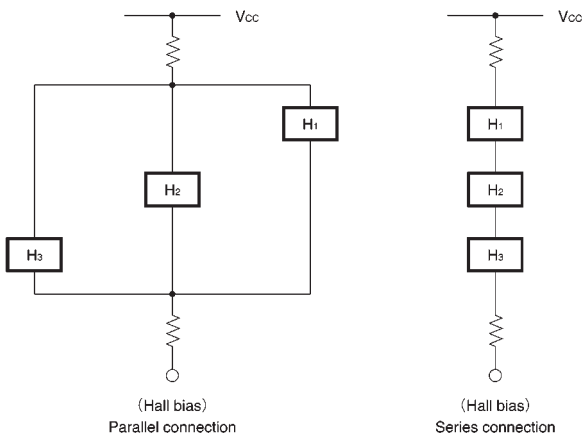

Fig.13

● Electrical characteristics curves

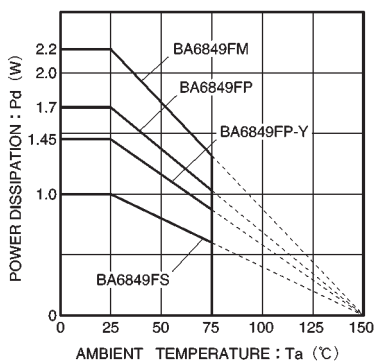

Fig.14 Package derating characteristics

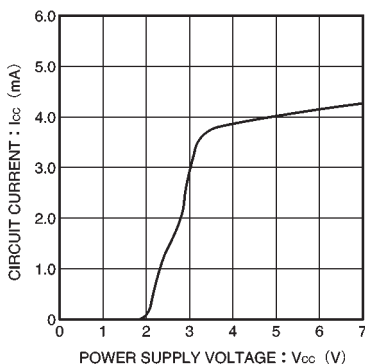

Fig.15 Power supply current vs. power supply voltage

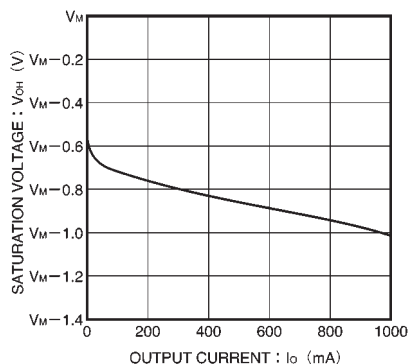

Fig.16 Upper-side output saturation voltage vs. output current

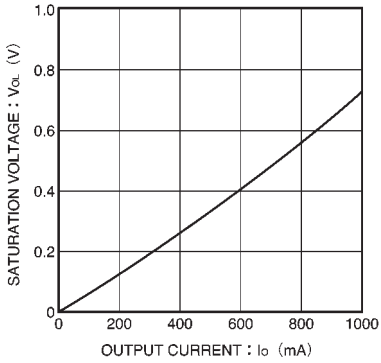

Fig.17 Lower-side output saturation voltage vs. output current

● External dimensions (Units: mm)

