

32 W hi-fi audio power amplifier

Features

- High output power (50 W music power IEC 268.3 rules)
- High operating supply voltage (50 V)
- Single or split supply operations
- Very low distortion
- Short-circuit protection (OUT to GND)
- Thermal shutdown

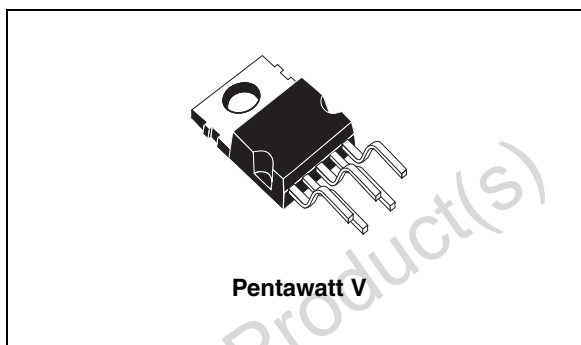

Description

The TDA 2050 is a monolithic integrated circuit in a Pentawatt package, intended for use as an audio class-AB audio amplifier.

Thanks to its high power capability the TDA2050 is able to provide up to 35 W true RMS power into a 4 ohm load at THD = 0%, $V_S = \pm 18\text{ V}$, $f = 1\text{ kHz}$ and up to 32 W into an 8 ohm load at THD = 10%, $V_S = \pm 22\text{ V}$, $f = 1\text{ kHz}$.

Moreover, the TDA2050 delivers typically 50 W music power into a 4 ohm load over 1 sec at $V_S = 22.5\text{ V}$, $f = 1\text{ kHz}$.

The high power and very low harmonic and crossover distortion (THD = 0.05% typ, at $V_S = \pm 22\text{ V}$, $P_O = 0.1\text{ to }15\text{ W}$, $R_L = 8\text{ ohm}$, $f = 100\text{ Hz to }15\text{ kHz}$) make the device most suitable for both hi-fi and high-end TV sets.

Table 1. Device summary

Order code	Package
TDA2050V	Pentawatt vertical

Figure 1. Test and application circuit

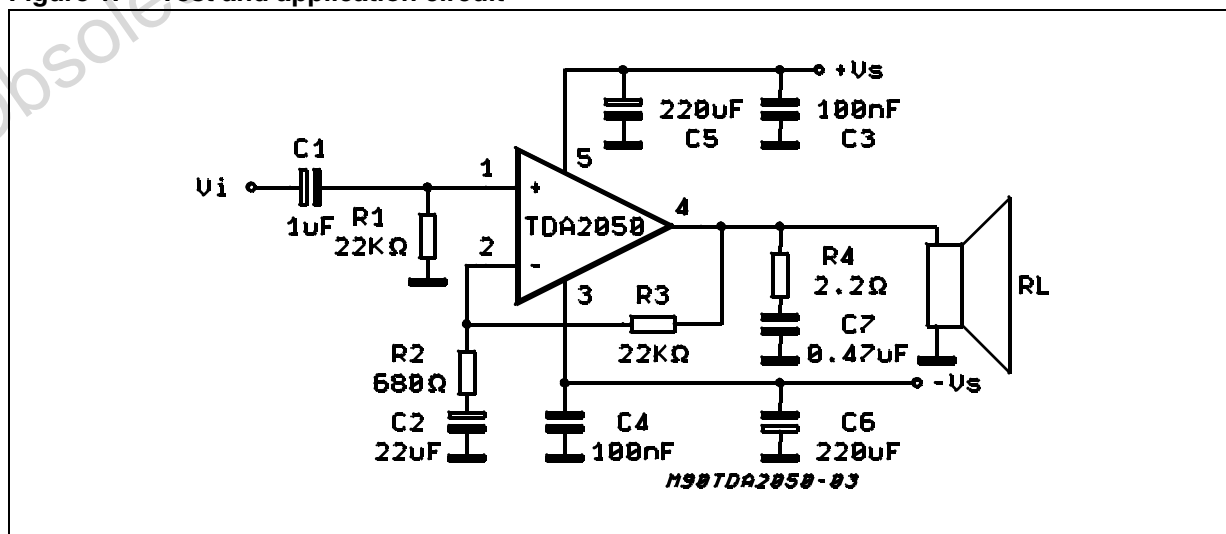

1 Device overview

Table 2. Absolute maximum ratings

Symbol	Parameter	Value	Unit
V_s	Supply voltage	± 25	V
V_i	Input voltage	V_s	
V_i	Differential input voltage	± 15	V
I_o	Output peak current (internally limited)	5	A
P_{tot}	Power dissipation at $T_{CASE} = 75\text{ }^\circ\text{C}$	25	W
T_{stg}, T_j	Storage and junction temperature	-40 to 150	$^\circ\text{C}$

Table 3. Thermal data

Symbol	Parameter	Value	Unit
$R_{th\ j-case}$	Thermal resistance junction-case	3 (max)	$^\circ\text{C}$

Figure 2. Pin connections (top view)

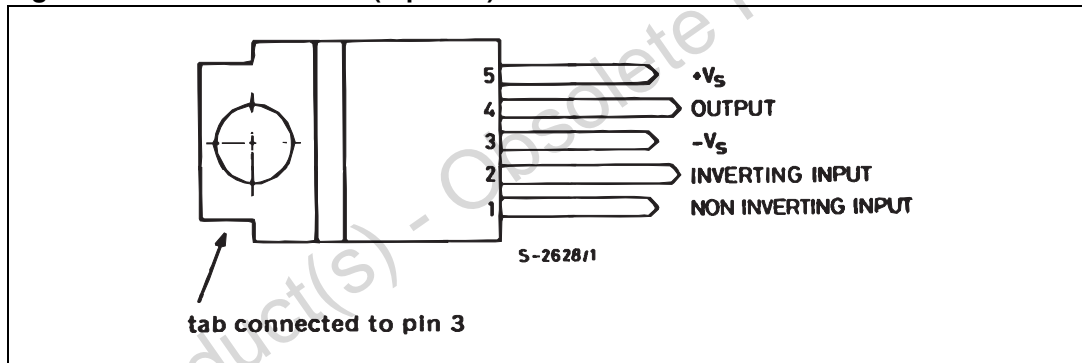
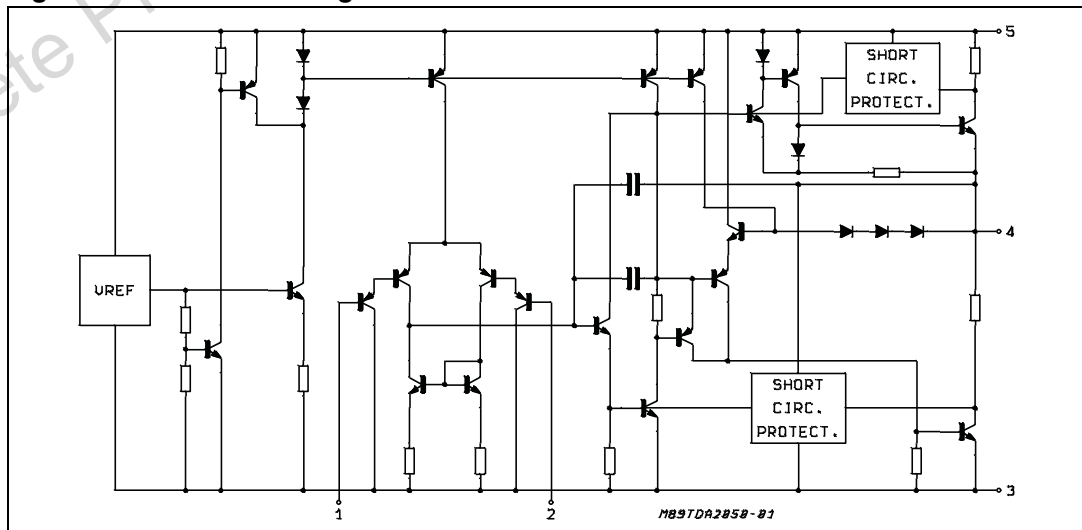

Figure 3. Schematic diagram



The values given in the following table refer to the test circuit $V_S = \pm 18\text{ V}$, $T_{\text{amb}} = 25\text{ }^\circ\text{C}$, $f = 1\text{ kHz}$, unless otherwise specified.

Table 4. Electrical characteristics

Symbol	Parameter	Test conditions	Min.	Typ.	Max.	Unit
V_S	Supply voltage range		± 4.5		± 25	V
I_d	Quiescent drain current	$V_S = \pm 4.5$ $V_S = \pm 25$		30 55	50 90	mA mA
I_b	Input bias current	$V_S = \pm 22$		0.1	0.5	μA
V_{OS}	Input offset voltage	$V_S = \pm 22$			± 15	mV
I_{OS}	Input offset current				± 200	nA
P_O	Output power	$d = 0.5\%$, $R_L = 4\ \Omega$ $R_L = 8\ \Omega$ $V_S = \pm 22\text{ V}, R_L = 8\ \Omega$	24 22	28 18 25		W W W
		$d = 10\%$, $R_L = 4\ \Omega$ $R_L = 8\ \Omega$ $V_S = \pm 22\text{ V}, R_L = 8\ \Omega$		35 22 32		W W W
		Music power IEC268.3 rules $d = 10\%$, $T = 1\text{ s}$ $R_L = 4\ \Omega; V_S = \pm 22.5\text{ V}$		50		W
d	Distortion	$P_O = 0.1\text{ to }24\text{ W}, R_L = 4\ \Omega, f = 1\text{ kHz}$ $f = 100\text{ to }10\text{ kHz}, P_O = 0.1\text{ to }18\text{ W}$		0.03	0.5 0.5	% %
		$V_S = \pm 22\text{ V}, R_L = 8\ \Omega,$ $f = 1\text{ kHz}, P_O = 0.1\text{ to }20\text{ W},$ $f = 100\text{ Hz to }10\text{ kHz};$ $P_O = 0.1\text{ to }15\text{ W}$		0.02	0.5	% %
SR	Slew rate		5	8		V/ μs
G_V	Voltage gain (open loop)	$f = 1\text{ kHz}$		80		dB
G_V	Voltage gain (closed loop)	$f = 1\text{ kHz}$	30	30.5	31	dB
BW	Power bandwidth (-3dB)	$V_i = 200\text{ mW}, R_L = 4\ \Omega;$	20 to 80.000			Hz
e_N	Input noise voltage	B = Curve A		4		μV
		B = 22 Hz to 22 kHz		5	10	μV
R_i	Input resistance (pin 1)		500			k Ω
SVR	Supply voltage rejection	$R_g = 22\text{ k}\Omega, f = 100\text{ Hz};$ $V_{\text{ripple}} = 0.5\text{ V}_{\text{RMS}}$		45		dB
h	Efficiency	$P_O = 28\text{ W}, R_L = 4\ \Omega$		65		%
		$P_O = 25\text{ W}, R_L = 8\ \Omega, V_S = \pm 22\text{ V},$		67		%
$T_{\text{sd-j}}$	Thermal shutdown junction temperature			150		$^\circ\text{C}$

Figure 4. Split-supply typical application circuit

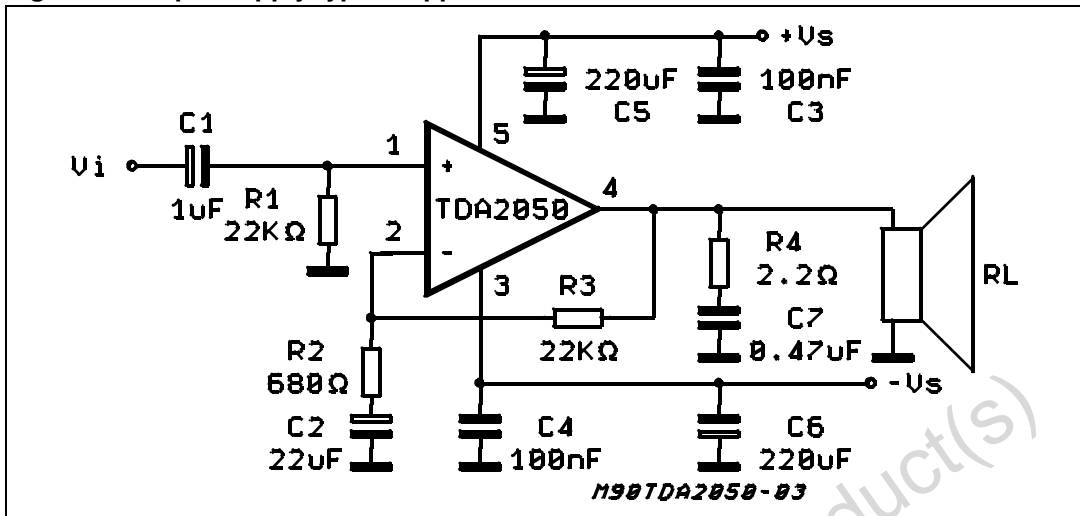
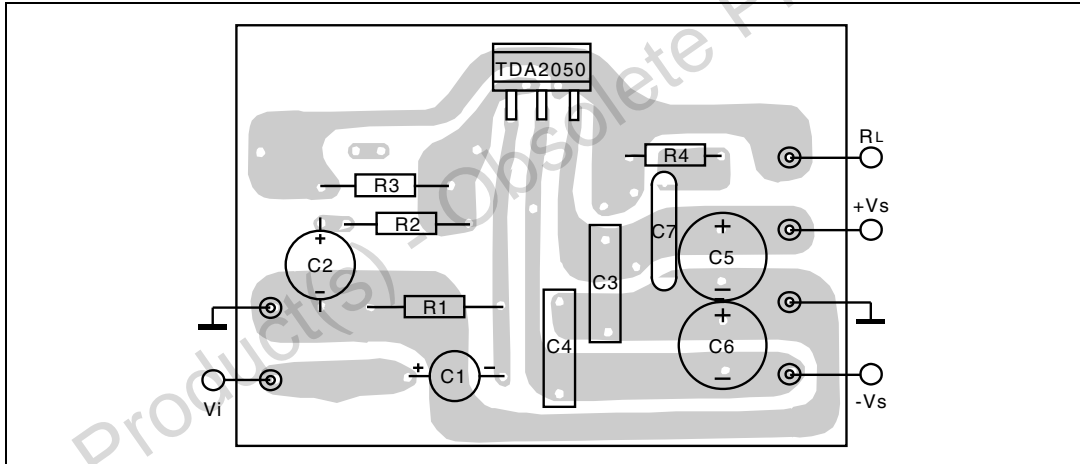

Figure 5. PC board and component layout of split-supply typical application circuit



2 Split-supply application suggestions

The recommended values of the external components are those shown on the application circuit of [Figure 5](#). Different values can be used. The following table can help the designer.

Table 5. Recommended values of external components

Component	Recommended value	Purpose	Larger than recommended value	Smaller than recommended value
R1	22 k Ω	Input impedance	Increase of input impedance	Decrease of Input Impedance
R2	680 Ω	Feedback resistor	Decrease of gain ⁽¹⁾	Increase of gain
R3	22 k Ω		Increase of gain	Decrease of gain ⁽¹⁾
R4	2.2 Ω	Frequency stability	Danger of oscillations	
C1	1 μ F	Input decoupling DC		Higher low-frequency cutoff
C2	22 μ F	Inverting input DC decoupling	Increase of switch ON/OFF noise	Higher low-frequency cutoff
C3, C4	100 nF	Supply voltage bypass		Danger of oscillation
C5, C6	220 μ F	Supply voltage bypass		Danger of oscillation
C7	0.47 μ F	Frequency stability		Danger of oscillation

1. The gain must be higher than 24 dB

2.1 Printed circuit board

The layout shown in *Figure 5* should be adopted by the designers. If different layouts are used, the ground points of input 1 and input 2 must be well decoupled from the ground return of the output in which a high current flows.

Figure 6. Single-supply typical application circuit

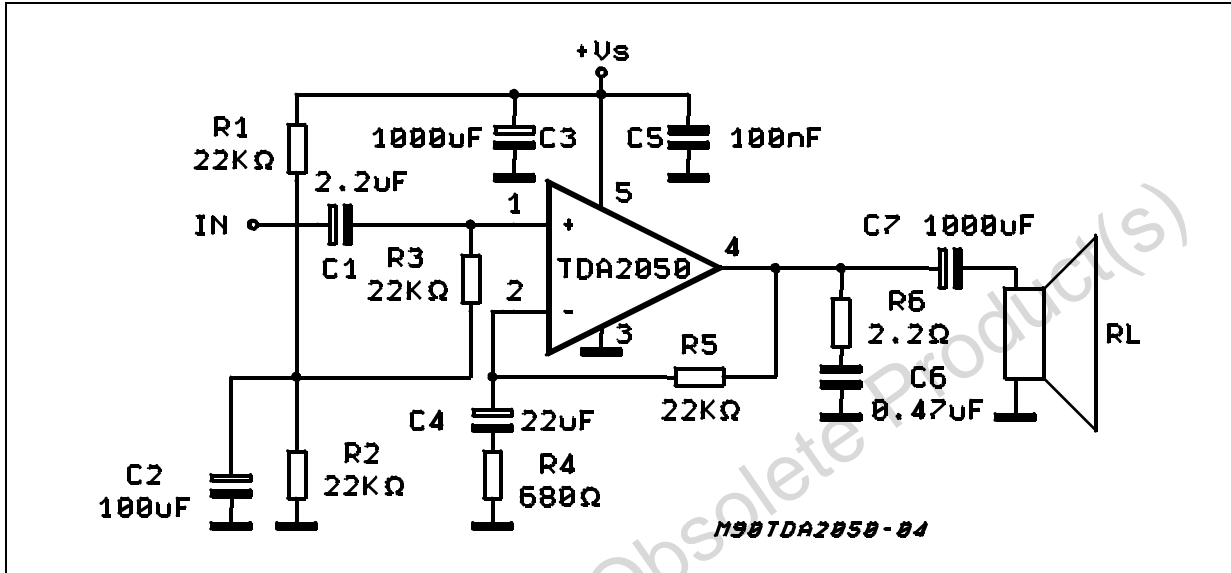
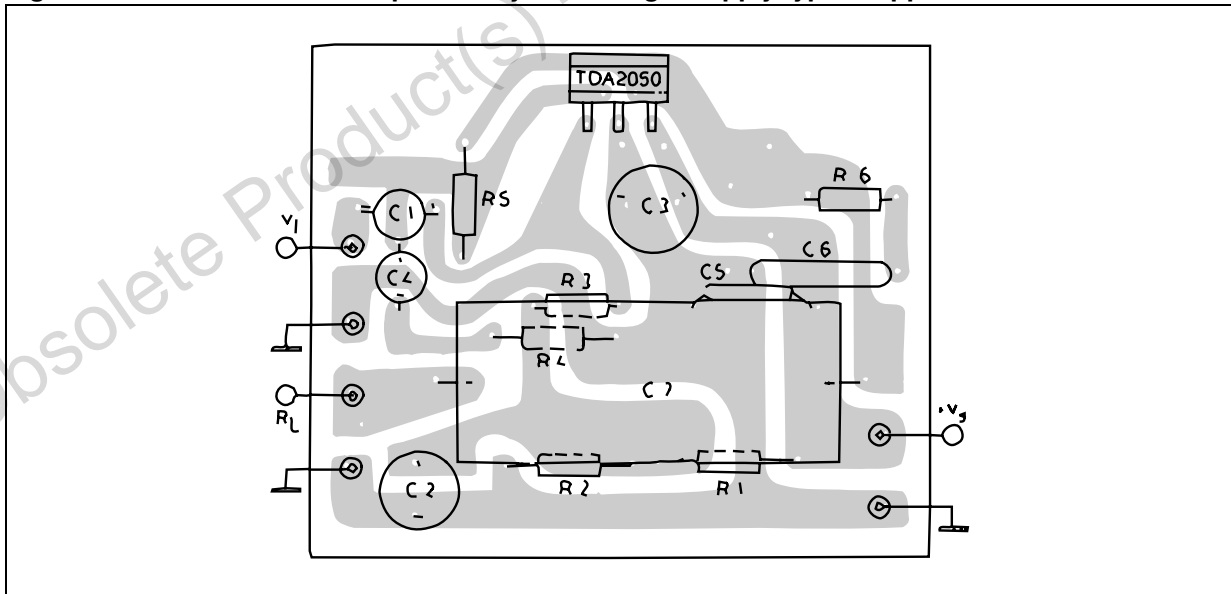

Figure 7. PC board and component layout of single-supply typical application circuit



3 Single-supply application suggestions

The recommended values of the external components are those shown in the application circuit of [Figure 6](#). Different values can be used. The following table can help the designer.

Table 6. Recommended values

Component	Recommended value	Purpose	Larger than recommended value	Smaller than recommended value
R1, R2, R3	22 k Ω	Biasing resistor		
R4	680 Ω	Feedback resistor	Increase of gain	Decrease of gain ⁽¹⁾
R5	22 k Ω		Decrease of gain ⁽¹⁾	Increase of gain
R6	2.2 Ω	Frequency stability	Danger of oscillations	
C1	2.2 μ F	Input decoupling DC		Higher low-frequency cutoff
C2	100 μ F	Supply voltage rejection	Worse turn-off transient Worse turn-on delay	
C3	1000 μ F	Supply voltage bypass		Danger of oscillations Worse turn-off transient
C4	22 μ F	Inverting input DC decoupling	Increase of switching ON/OFF	Higher low-frequency cutoff
C5	100 nF	Supply voltage bypass		Danger of oscillations
C6	0.47 μ F	Frequency stability		Danger of oscillations
C7	1000 μ F	Output DC decoupling		Higher low-frequency cutoff

1. The gain must be higher than 24 dB

Note: *If the supply voltage is lower than 40 V and the load is 8 ohm (or more), a lower value of C2 can be used (i.e. 22 mF). C7 can be larger than 1000 μ F only if the supply voltage does not exceed 40 V.*

4 Typical characteristics (split-supply test circuit unless otherwise specified)

Figure 8. Output power vs. supply voltage

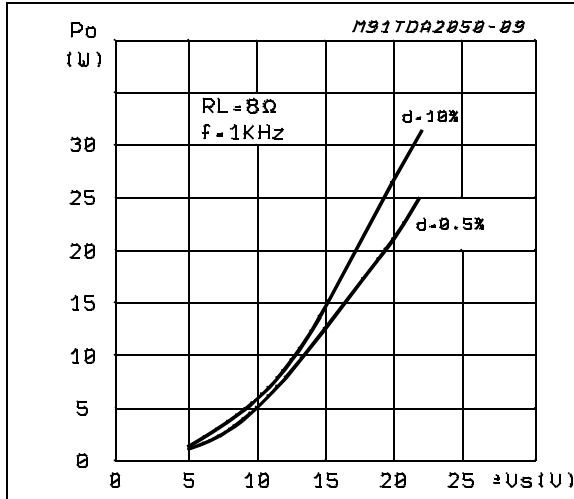

Figure 9. Distortion vs. output power

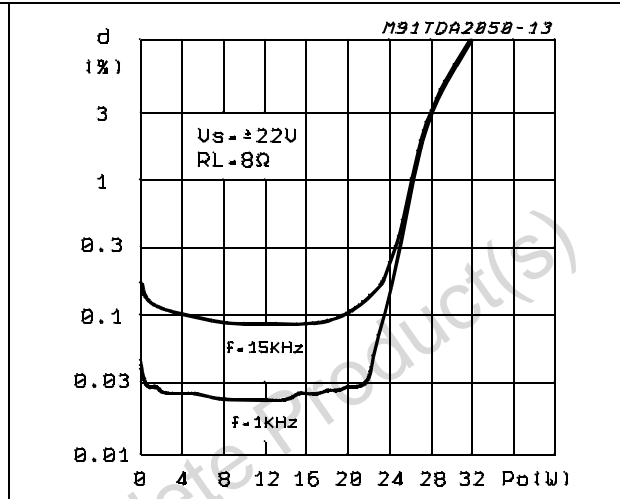

Figure 10. Output power vs. supply voltage

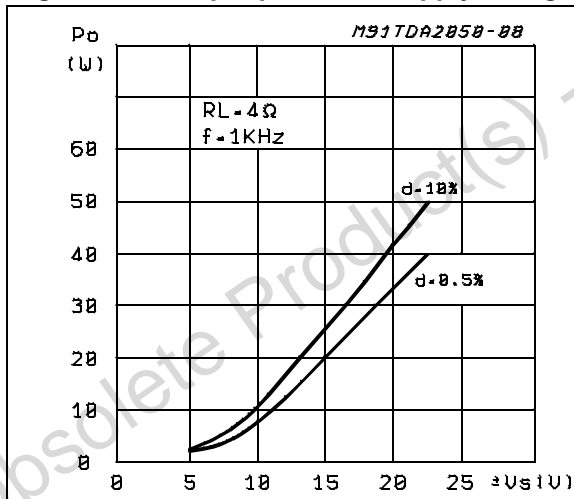

Figure 11. Distortion vs. output power

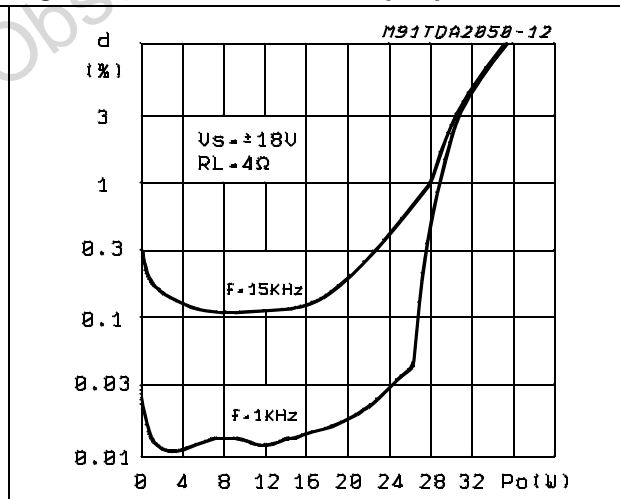

Figure 12. Distortion vs. frequency

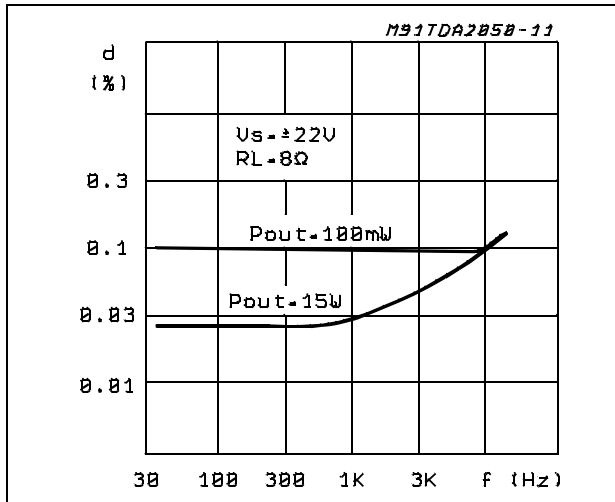

Figure 13. Distortion vs. frequency

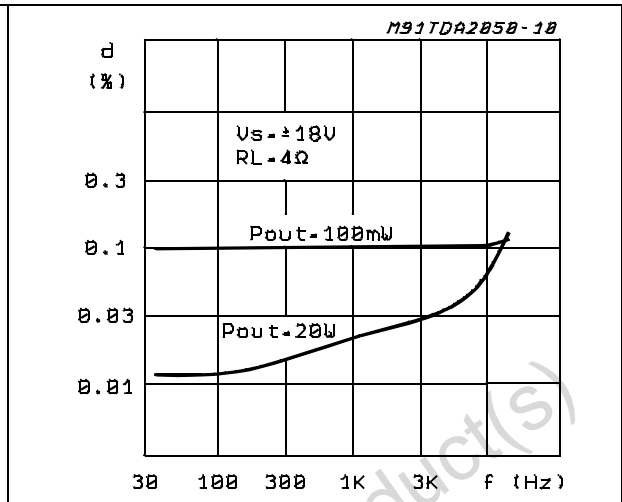

Figure 14. Quiescent current vs. supply voltage

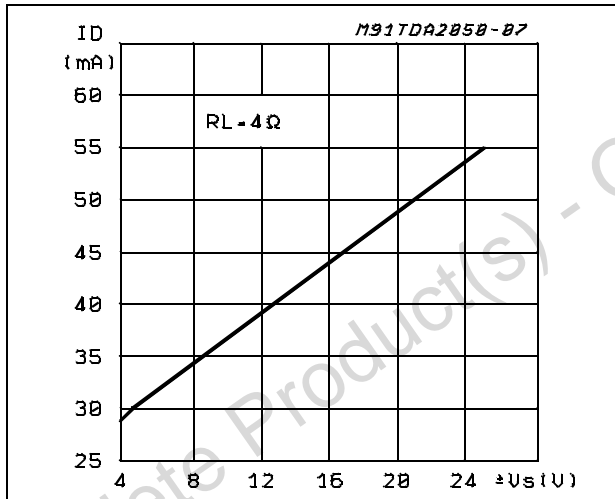

Figure 15. Supply voltage rejection vs. frequency

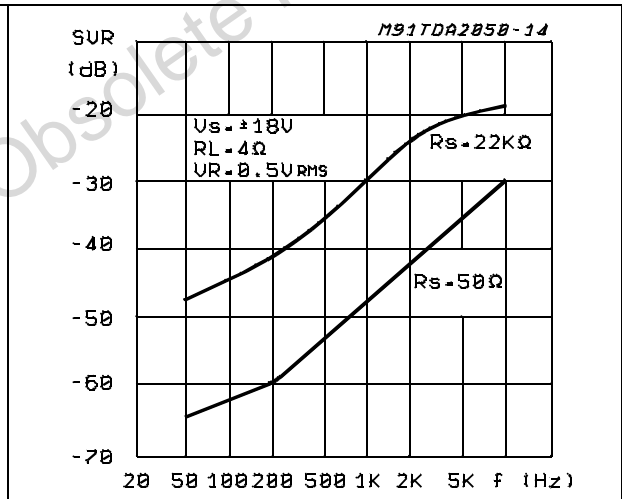

Figure 16. Supply voltage rejection vs. frequency (single-supply) for different values of C2 (Figure 6)

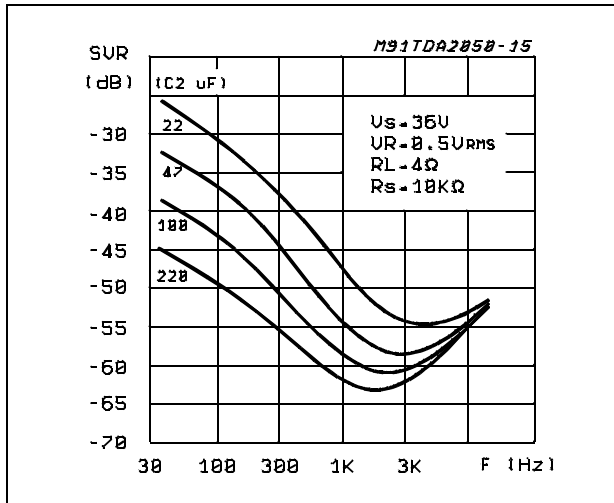

Figure 17. Supply voltage rejection vs. frequency (single-supply) for different values of C2 (Figure 6)

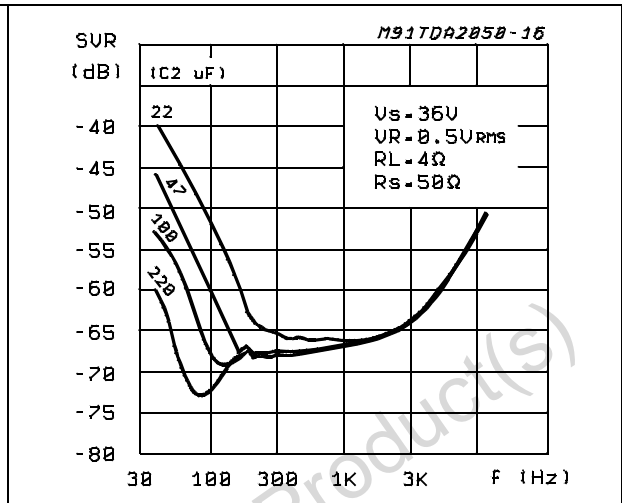

Figure 18. Total power dissipation and efficiency vs. output power

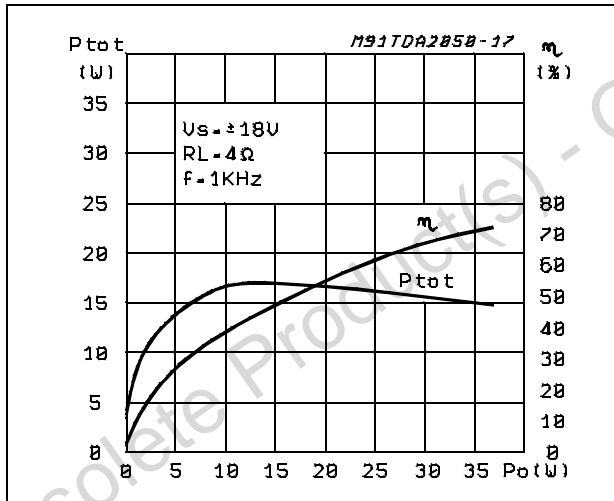
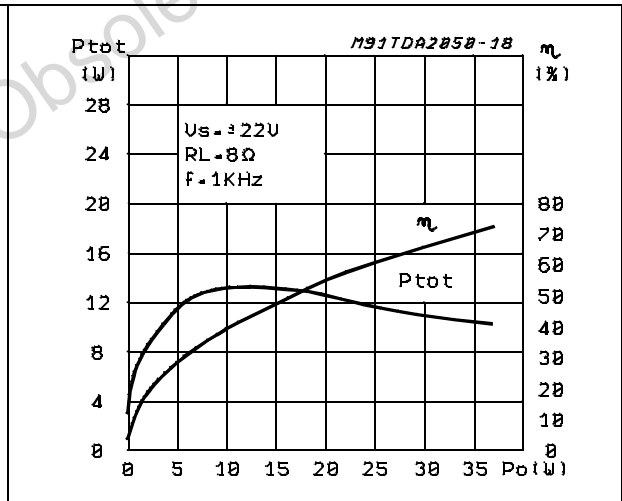

Figure 19. Total power dissipation and efficiency vs. output power



5 Short-circuit protection

The TDA2050 has an original circuit which limits the current of the output transistors. The maximum output current is a function of the collector emitter voltage, hence the output transistors work within their safe operating area. This function can therefore be considered as being peak power limiting rather than simple current limiting. It reduces the possibility that the device gets damaged during an accidental short-circuit from AC output to ground.

Obsolete Product(s) - Obsolete Product(s)

6 Thermal shutdown

The presence of a thermal limiting circuit offers the following advantages:

1. An overload on the output (even if it is permanent), or an above-limit ambient temperature can be easily tolerated since T_j cannot be higher than 150 °C.
2. The heatsink can have a smaller factor of safety compared with that of a conventional circuit. There is no possibility of device damage due to high junction temperature. If for any reason, the junction temperature increases up to 150 °C, the thermal shutdown simply reduces the power dissipation and the current consumption.

The maximum allowable power dissipation depends upon the thermal resistance junction-ambient. *Figure 20* shows this dissippable power as a function of ambient temperature for different thermal resistances.

Figure 20. Maximum allowable power dissipation vs. ambient temperature

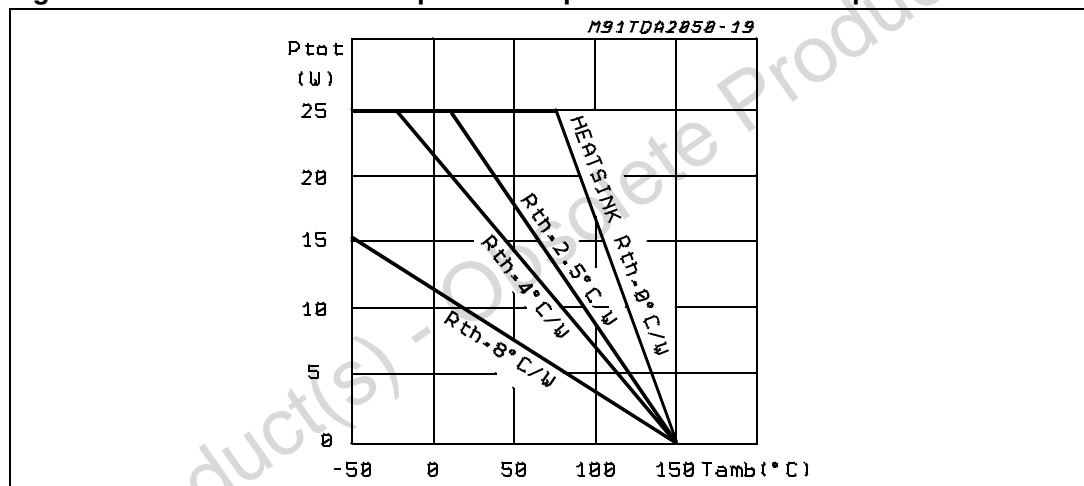

6.1 Mounting instructions

The power dissipated in the circuit must be removed by adding an external heatsink. Thanks to the pentawatt package, the heatsink mounting operation is very simple, a screw or a compression spring (clip) being sufficient. Between the heatsink and the package it is better to insert a layer of silicon grease, to optimize the thermal contact; no electrical isolation is needed between the two surfaces. *Figure 21* shows an example of a heatsink.

6.2 Dimension recommendations

The following table shows the length that the heatsink in [Figure 21](#) must have for several values of P_{tot} and R_{th} .

Table 7. Dimension recommendations

P_{tot} (W)	12	8	6
Length of heatsink (mm)	60	40	30
R_{th} of heatsink ($^{\circ}C/W$)	4.2	6.2	8.3

Figure 21. Example of heatsink

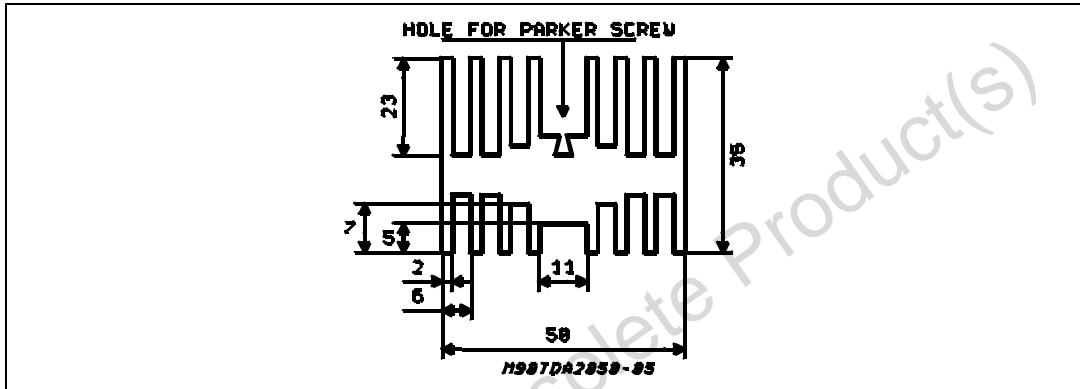

Appendix A

A.1 Music power concept

Music power is (according to the IEC clauses n.268-3 of Jan. 83) the maximum power which the amplifier is capable of producing across the rated load resistance (regardless of non-linearity) 1 sec after the application of a sinusoidal input signal of frequency 1 kHz.

According to this definition our method of measurement comprises the following steps:

- Set the voltage supply at the maximum operating value
- Apply a input signal in the form of a 1 kHz tone burst of 1 sec duration: the repetition period of the signal pulses is 60 sec
- The output voltage is measured 1 sec from the start of the pulse
- Increase the input voltage until the output signal shows a THD=10%
- The music power is then V_{out}^2 / R_L , where V_{out} is the output voltage measured in the condition of point 4 and R_L is the rated load impedance

The target of this method is to avoid excessive dissipation in the amplifier.

A.2 Instantaneous power

Another power measurement (maximum instantaneous output power) was proposed by the IEC in 1988 (IEC publication 268-3 subclause 19.A). We give here only a brief extract of the concept, and a circuit useful for the measurement. The supply voltage is set at the maximum operating value.

The test signal consists of a sinusoidal signal whose frequency is 20 Hz, to which are added alternate positive and negative pulses of 50 μ s duration and 500 Hz repetition rate. The amplitude of the 20 Hz signal is chosen to drive the amplifier to its voltage clipping limits, while the amplitude of the pulses takes the amplifier alternately into its current-overload limits. A circuit for generating the test signal is given in [Figure 22](#).

The load network consists of a 40 μ F capacitor, in series with a 1 ohm resistor. The capacitor limits the current due to the 20 Hz signal to a low value, whereas for the short pulses the effective load impedance is of the order of 1 ohm, and a high output current is produced.

Using this signal and load network the measurement may be made without causing excessive dissipation in the amplifier. The dissipation in the 1 ohm resistor is much lower than a rated output power of the amplifier, because the duty-cycle of the high output current is low. By feeding the amplifier output voltage to the Xplates of an oscilloscope, and the voltage across the 1 ohm resistor (representing the output current) to the Y=plates, it is possible to read on the display the value of the maximum instantaneous output power.

The result of this test applied on the TDA2050 is:

$$\text{Peak power} = 100 \text{ W typ}$$

Figure 22. Test circuit for peak power measurement

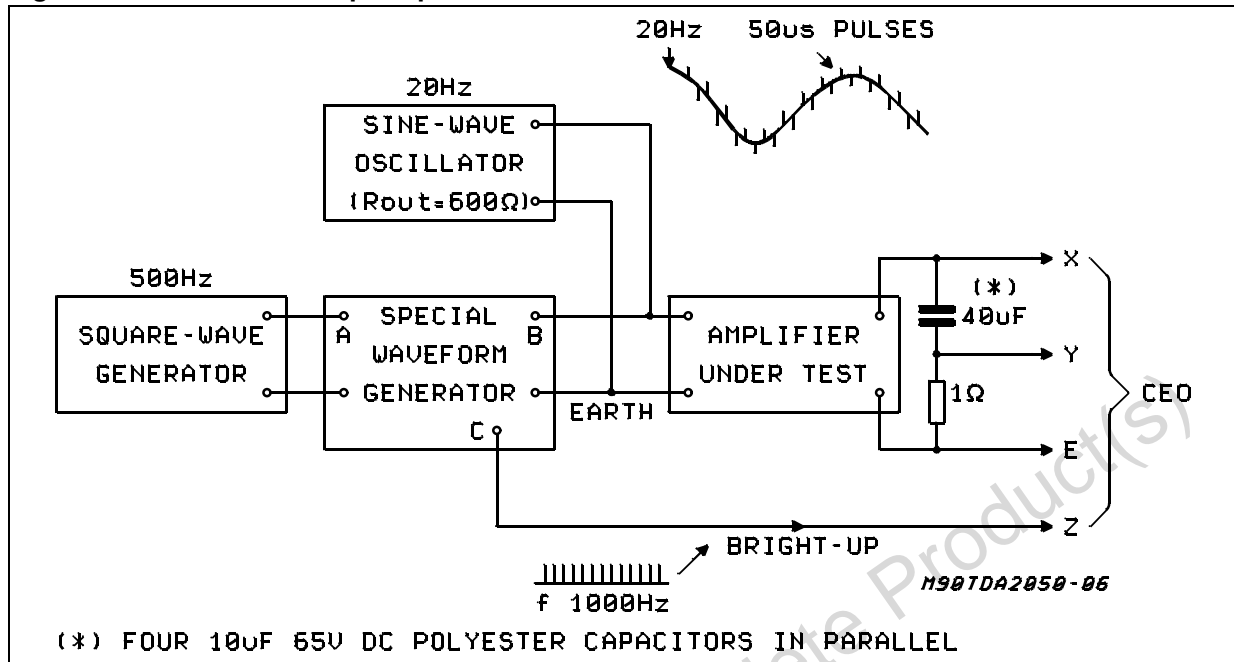

Obsolete Product(s) - Obsolete Product(s)

7 Package mechanical data

Figure 23. Pentawatt V package

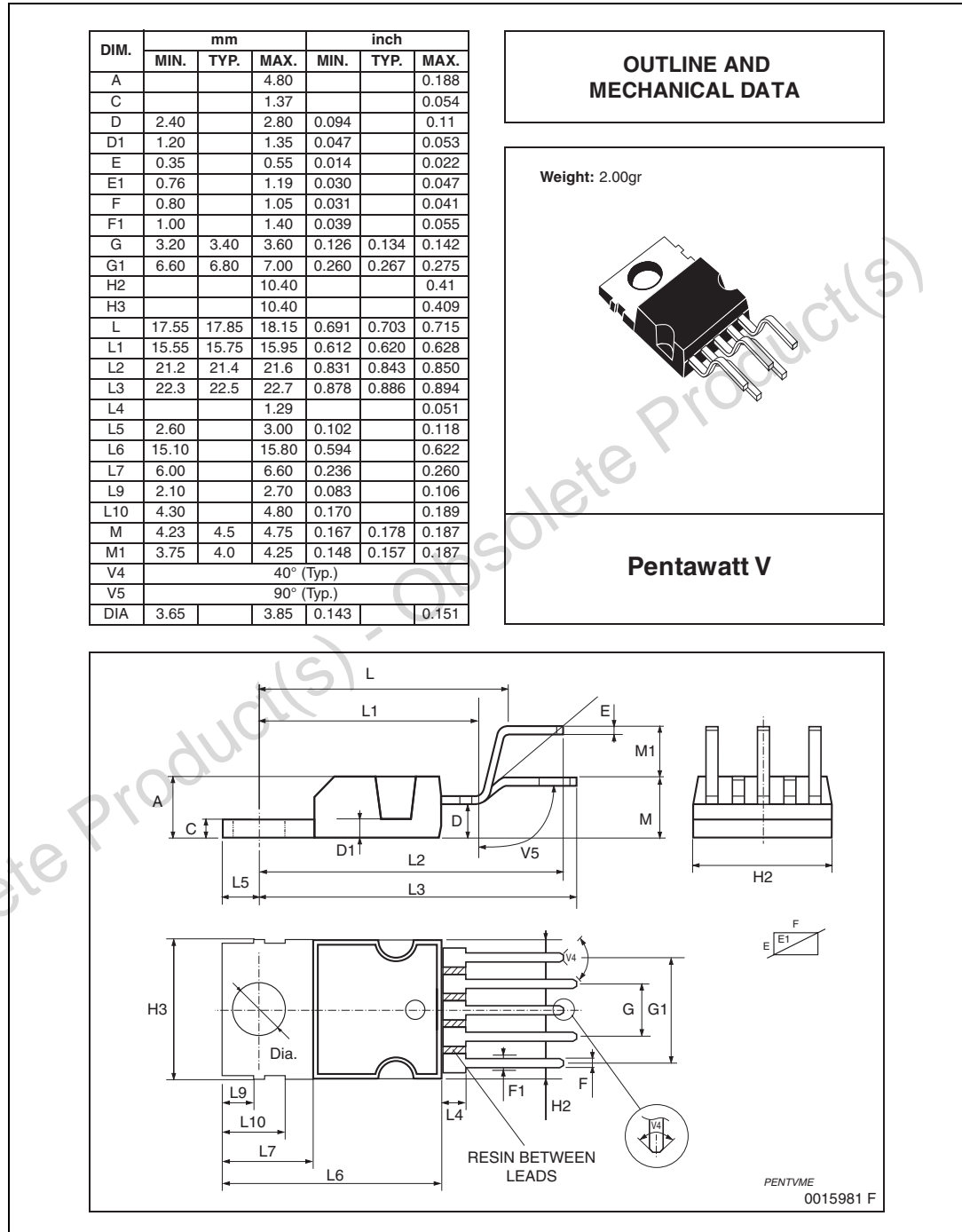

In order to meet environmental requirements, ST offers these devices in different grades of ECOPACK® packages, depending on their level of environmental compliance. ECOPACK® specifications, grade definitions and product status are available at: www.st.com. ECOPACK® is an ST trademark.

8 Revision history

Table 8. Document revision history

Date	Revision	Changes
31-Aug-2011	3	Removed minimum value from Pentawatt (vertical) package dimension H3 in Figure 23: Pentawatt V package Revised general presentation, minor textual updates

Obsolete Product(s) - Obsolete Product(s)

Please Read Carefully:

Information in this document is provided solely in connection with ST products. STMicroelectronics NV and its subsidiaries ("ST") reserve the right to make changes, corrections, modifications or improvements, to this document, and the products and services described herein at any time, without notice.

All ST products are sold pursuant to ST's terms and conditions of sale.

Purchasers are solely responsible for the choice, selection and use of the ST products and services described herein, and ST assumes no liability whatsoever relating to the choice, selection or use of the ST products and services described herein.

No license, express or implied, by estoppel or otherwise, to any intellectual property rights is granted under this document. If any part of this document refers to any third party products or services it shall not be deemed a license grant by ST for the use of such third party products or services, or any intellectual property contained therein or considered as a warranty covering the use in any manner whatsoever of such third party products or services or any intellectual property contained therein.

UNLESS OTHERWISE SET FORTH IN ST'S TERMS AND CONDITIONS OF SALE ST DISCLAIMS ANY EXPRESS OR IMPLIED WARRANTY WITH RESPECT TO THE USE AND/OR SALE OF ST PRODUCTS INCLUDING WITHOUT LIMITATION IMPLIED WARRANTIES OF MERCHANTABILITY, FITNESS FOR A PARTICULAR PURPOSE (AND THEIR EQUIVALENTS UNDER THE LAWS OF ANY JURISDICTION), OR INFRINGEMENT OF ANY PATENT, COPYRIGHT OR OTHER INTELLECTUAL PROPERTY RIGHT.

UNLESS EXPRESSLY APPROVED IN WRITING BY TWO AUTHORIZED ST REPRESENTATIVES, ST PRODUCTS ARE NOT RECOMMENDED, AUTHORIZED OR WARRANTED FOR USE IN MILITARY, AIR CRAFT, SPACE, LIFE SAVING, OR LIFE SUSTAINING APPLICATIONS, NOR IN PRODUCTS OR SYSTEMS WHERE FAILURE OR MALFUNCTION MAY RESULT IN PERSONAL INJURY, DEATH, OR SEVERE PROPERTY OR ENVIRONMENTAL DAMAGE. ST PRODUCTS WHICH ARE NOT SPECIFIED AS "AUTOMOTIVE GRADE" MAY ONLY BE USED IN AUTOMOTIVE APPLICATIONS AT USER'S OWN RISK.

Resale of ST products with provisions different from the statements and/or technical features set forth in this document shall immediately void any warranty granted by ST for the ST product or service described herein and shall not create or extend in any manner whatsoever, any liability of ST.

ST and the ST logo are trademarks or registered trademarks of ST in various countries.

Information in this document supersedes and replaces all information previously supplied.

The ST logo is a registered trademark of STMicroelectronics. All other names are the property of their respective owners.

© 2011 STMicroelectronics - All rights reserved

STMicroelectronics group of companies

Australia - Belgium - Brazil - Canada - China - Czech Republic - Finland - France - Germany - Hong Kong - India - Israel - Italy - Japan - Malaysia - Malta - Morocco - Philippines - Singapore - Spain - Sweden - Switzerland - United Kingdom - United States of America

www.st.com