

## 5-MODE PRESET EQUALIZER WITH BASS BOOSTER

### DESCRIPTION

The SC5388 is a 2-channel digital preset equalizer utilizing CMOS technology. It provides 5 different sound selections, namely: Flat/normal, rock, Pops, Classic and Jazz. A Bass Booster may be added any of 5 sound selections, thereby creating more audio versatility. SC5388 provides two types of key selection mode namely: the Direct and the Cyclic. Pin assignment and application circuit are optimized for cost saving advantages and easy PCB layout.

### FEATURES

- \* Wide operating voltage range(VCC=5.0V ~ 11.0V)
- \* Low total harmonic distortion and high S/N ratio  
(THD+N<0.02%, S/N > 95dB)
- \* LED display output mode
- \* Less external parts
- \* 5-sound selections provided
- \* Bass booster function
- \* Direct and cyclic key selection provided
- \* 2-Channel output

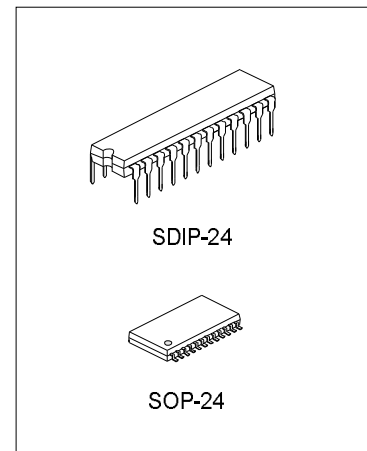

### ORDERING INFORMATION

Device	Package
SC5388	SDIP-24-300-2.54
SC5388S	SOP-24-375-1.27

### APPLICATIONS

- \* Walkman
- \* Car Audio
- \* Fader and MPEG Card
- \* Multimedia Audio components

### BLOCK DIAGRAM

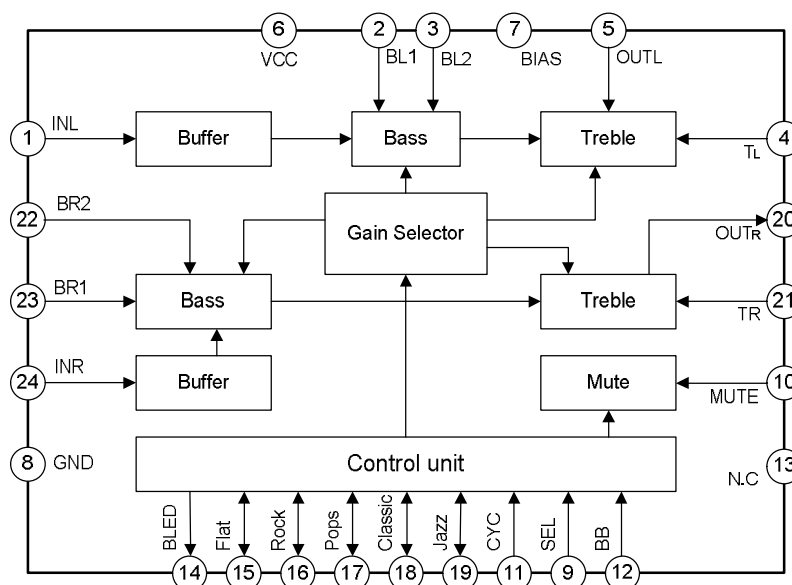

**ABSOLUTE MAXIMUM RATINGS**

Characteristics	Symbol	Ratins	Unit
Supply Voltage	V <sub>CC</sub>	11.0	V
Input Voltage	V <sub>IN</sub>	0.3 ~ V <sub>CC</sub> +0.3V	V
Power Dissipation	P <sub>D</sub>	200	mW
Operating Temperature	T <sub>opr</sub>	-20 ~ +75	°C
Storage Temperature	T <sub>stg</sub>	-40 ~ +125	°C

**ELECTRICAL CHARACTERISTICS** (T<sub>amb</sub>=25°C, V<sub>CC</sub>=9.0V, V<sub>i</sub>=1V<sub>rms</sub>, f=1kHz, Unless otherwise specified)

Characteristics	Symbol	Test conditions	Min.	Typ.	Max.	Unit
Operating Supply Voltage	V <sub>CC</sub>		5.0	9.0	11.0	V
Operating Supply Current	I <sub>CC</sub>	V <sub>CC</sub> =9v, V <sub>i</sub> =0, Flat Mode		11		mA
Maximum Output Voltage	V <sub>OM</sub>	V <sub>CC</sub> =9.0V	3.5			V <sub>rms</sub>
Output Noise	V <sub>NO</sub>	V <sub>CC</sub> =9.0V, V <sub>i</sub> =0, BW=400~30kHz , A-weighting			20	μV <sub>rms</sub>
Total Harmonic Distortion	THD	V <sub>CC</sub> =9.0V, V <sub>i</sub> =0.2V <sub>rms</sub> , BW=400~30kHz , A-weighting			0.02	%
Input Impedance	R <sub>IN</sub>	V <sub>CC</sub> =9.0V	50	60		kΩ
Output Impedance	R <sub>OUT</sub>	V <sub>CC</sub> =9.0V		5.5		kΩ
Maximum Input Voltage	V <sub>I(max)</sub>	V <sub>CC</sub> =9.0V			2.0	V <sub>rms</sub>

**PIN CONFIGURATIONS**

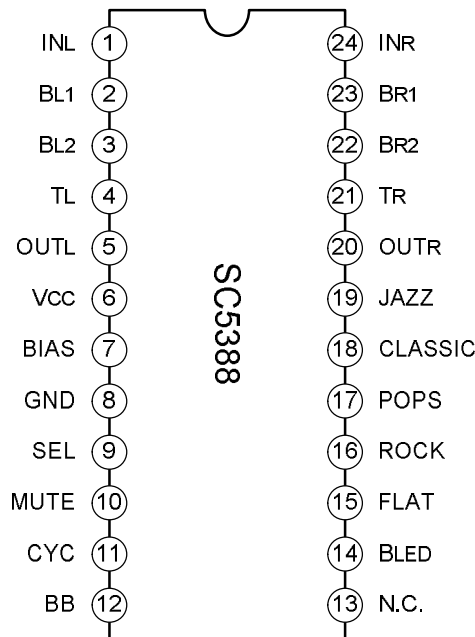

**PIN DESCRIPTION**

Pin No.	Pin Name	Description
1	INL	Left Channel Input.
2	BL1	Left Bass Control Pin 1. A Capacitor may be Connected between this Pin and BL2
3	BL2	Left Bass Control Pin 2. A Capacitor may be Connected between this Pin and BL1.
4	TL	Left Treble Control Pin . A Capacitor may be Connected between this Pin and OUTL.
5	OUTL	Left Channel Output in.
6	VCC	Positive Supply Voltage.
7	BIAS	A capacitor may be connected between this Pin and GND.
8	GND	Ground.
9	SEL	Select Control Pin.
10	MUTE	Mute Pin. The Mute Pin can eliminate the noise when mode changing occurs. A capacitor is connected between this Pin and GND.
11	CYC	Cyclic Select Pin.
12	BB	Bass Booster Control Input Pin.
13	NC	No Connected.
14	BLED	Bass Booster Control Input Pin.
15	FLAT	FLAT Mode Display & Control Input Pin.
16	ROCK	ROCK Mode Display & Control Input Pin.
17	POPS	POPS Mode Display & Control Input Pin.
18	CLASSIC	CLASSIC Mode Display & Control Input Pin.
19	JASS	JASS Mode Display & Control Input Pin.
20	OUTR	Right Channel Output in.
21	BR1	Right Bass Control Pin 1. A Capacitor may be Connected between this Pin and BR2.
22	BR2	Right Bass Control Pin 2. A Capacitor may be Connected between this Pin and BR1.
23	TR	Right Treble Control Pin . A Capacitor may be Connected between this Pin and OUTR.
24	INR	Right Channel Input.

## FUNCTIONAL DESCRIPTION

The SC5388 is a 2-channel and 5-Mode digital preset equalizer with a Bass Booster function. It provides two types of key selection mode namely: the Direct and the Cyclic. These two key selection Modes are determined by SEL pin. Please refer to the table below:

Key Selection Mode	SEL Pin	Description
Direct	Low	Press FLAT key to activate Flat Mode
		Press ROCK key to activate Rock Mode
		Press POPS key to activate Pops Mode
		Press CLASSIC key to activate Classic Mode
		Press JAZZ key to activate Jazz Mode
Cyclic	Floating/High	...Flat→ Rock →Pops→ Classic→ Jazz →Flat→Rock...

Note: 1). The Bass Booster can be controlled in the same manner under the Direct or the Cyclic Key selection Mode. To turn the Bass Booster ON or OFF, press the BB Key.

2). Under the Cyclic Selection mode, press the CYC Key, to go to the next sound selection.

### 1. CYCLIC KEY SELECTION MODE

As seen in the table above, the cyclic key selection mode is active when the SEL pin is floating or "high". Under this mode, any of the sound selections (Flat, Rock, Pops, classic, Jazz) may be selected by pressing the CYC key. The default value is the Flat Mode. This Means that when power is turned ON, the mode is active. Pressing the Cyclic Key lets you go from one sound selection to the other in the following order: Flat→ Rock →Pops→ Classic → Jazz. That is, press the CYC key to activate the next mode. The BB key controls the Bass Booster. When the power is turned ON, the bass Booster is OFF.

### 2. DIRECT KEY SELECTION MODE

The direct key selection mode is active when the SEL pin is set to "LOW". As the name implies, you can directly select the sound selection you like simply by pressing the respective keys. This means, that to select the JAZZ mode, press the JAZZ key, CLASSIC Mode, press the CLASSIC key and so forth. Take note that when the power is turned On, the Flat Mode is active. The Bass Booster is independent of the key/sound mode selected and may be turned ON or OFF at any time.

### 3. FREQUENCY RESPONSE

The Fig.1 ~ Fig.5 illustrate the various frequency response under the various sound selection (Flat, Rock, Pops, Classic, Jazz, and Bass Booster).

Different sound selections exhibit different frequency gains at different frequency levels. Please refer to the table below:

Sound Selection	Typical			Unit
	f=80Hz	f=1kHz	f=10kHz	
Flat	1.7	-0.8	-1.3	dB
Rock	10.0	1.5	7.0	
Pops	6.5	0.5	7.0	
Classic	6.0	0.5	1.0	
Jazz	10.0	1.2	3.3	
Flat + Bass Booster	8.5	0.7	1.0	
Rock + Bass Booster	11.0	2.0	7.0	
Pops + Bass Booster	9.5	1.0	7.0	
Classic + Bass Booster	9.5	1.0	1.0	
Jazz + Bass Booster	11.0	2.0	2.5	

## TREBLE AND BASS ADJUSTMENTS

It is general knowledge that different individuals have different listening preference. The application circuit of SC5388 included in this specification has been designed for the taste general listening public; however, you can make the necessary adjustment to suit your personal taste. Please refer to the Section below.

### 1. TREBLE ADJUSTMENT

The Treble adjustment is made by changing the value of the 2 capacitors connected between TL-OUTL, TR-OUTR, Please refer to Fig. 6.

As the capacitor value becomes bigger, the treble of the gain frequency curve is shifted down. Likewise, as the capacitor value become smaller, the treble gain frequency curve shifts the opposite direction. Referring to the Fig.6. we see that at 6dB, different capacitor values exhibit different frequency response. Capacitor value 1800pF has a lower frequency gain response than 1200pF capacitor.

### 2. BASS ADJUSTMENT

Bass adjustment can be made by changing the values of the capacitor connected between BL1~BL2 and BR1~BR2. Please refer to Fig.7.

The larger the capacitor value used, the frequency response curve shifts down. Like wise, the smaller the capacitor value, the frequency response curve shifts the opposite direction. In Fig.7, at 9dB different capacitor value exhibit different frequency responses. A capacitor with a value of 0.1 $\mu$ F has smaller frequency response than 0.56 $\mu$ F capacitor.

Fig.1 Flat Mode(Flat mode + Bass Booster)

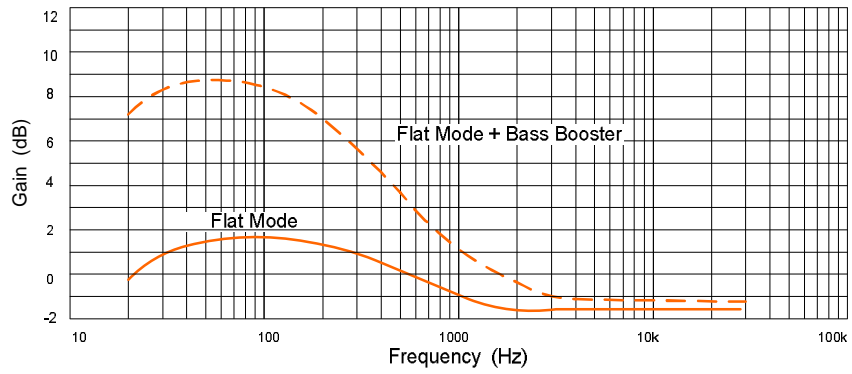

Fig.2 Rock Mode(Rock mode + Bass Booster)

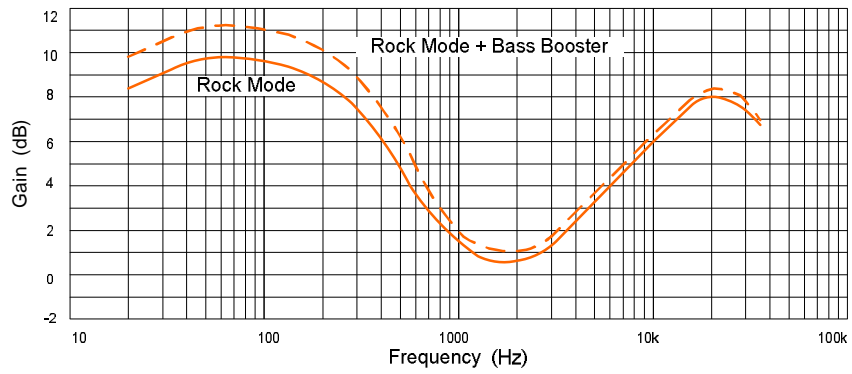

Fig.3 Pops Mode(Pops mode + Bass Booster)

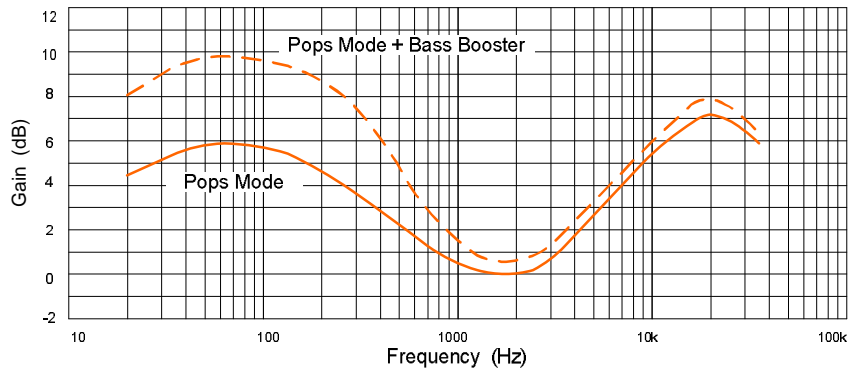

Fig.4 Classic mode(Classic mode + Bass Booster)

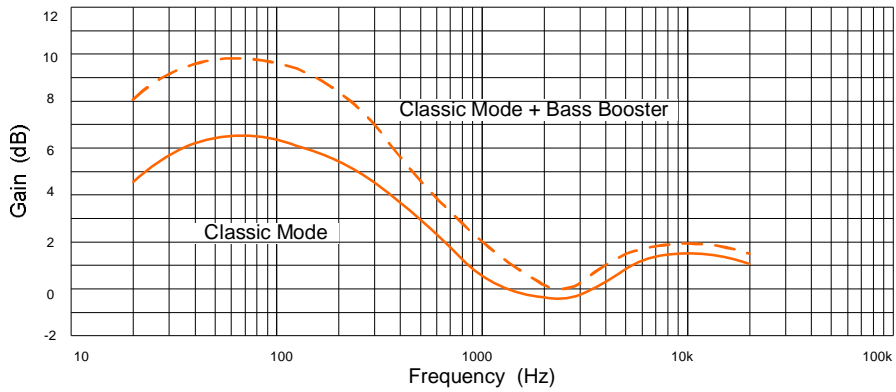

Fig.5 Jazz Mode(Jazz mode + Bass Booster)

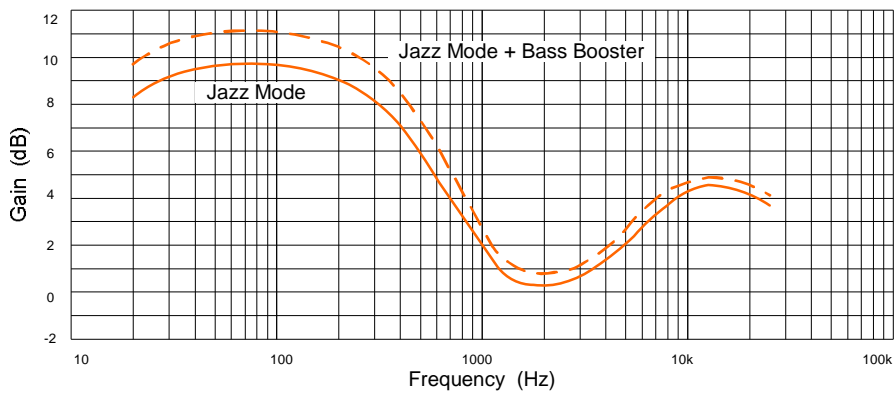

Fig.6 TL-OUTL Capacitors vs. Frequency Response

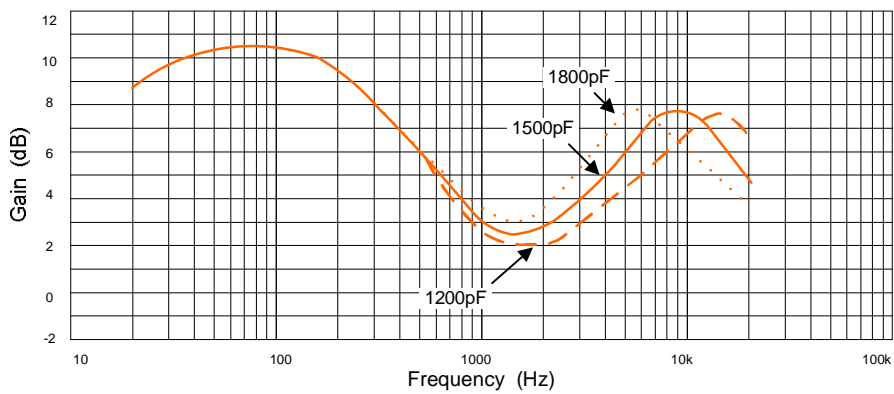
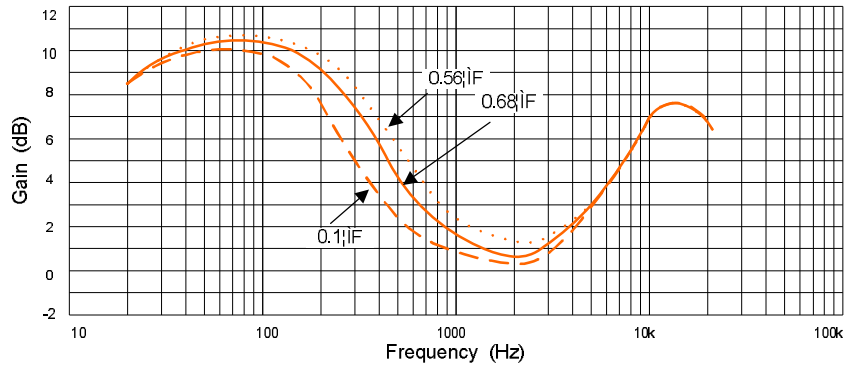
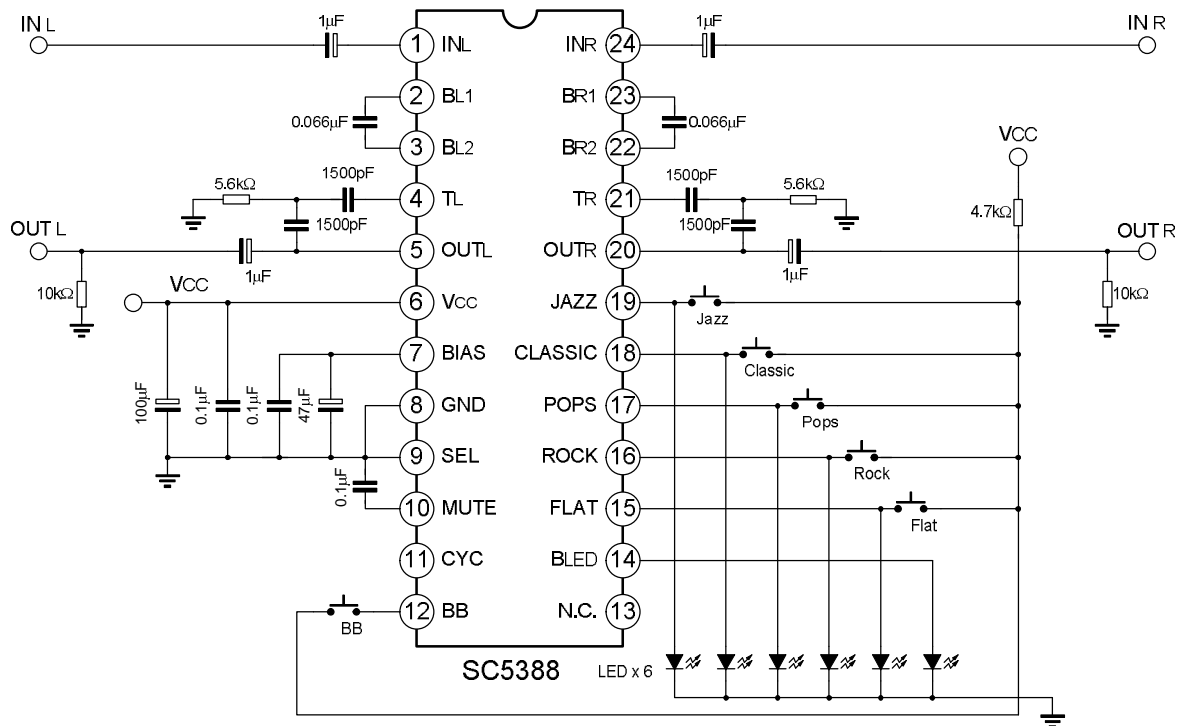

Fig.7 BL1-BL2 Capacitors vs. Frequency Response



## APPLICATION CIRCUIT

### DIRECT KEY MODE



Note: Please use 0.068µF, 1500pF Mylar Capacitors.



**APPLICATION CIRCUIT (CONTINUED)**

**CYCLIC KEY MODE**

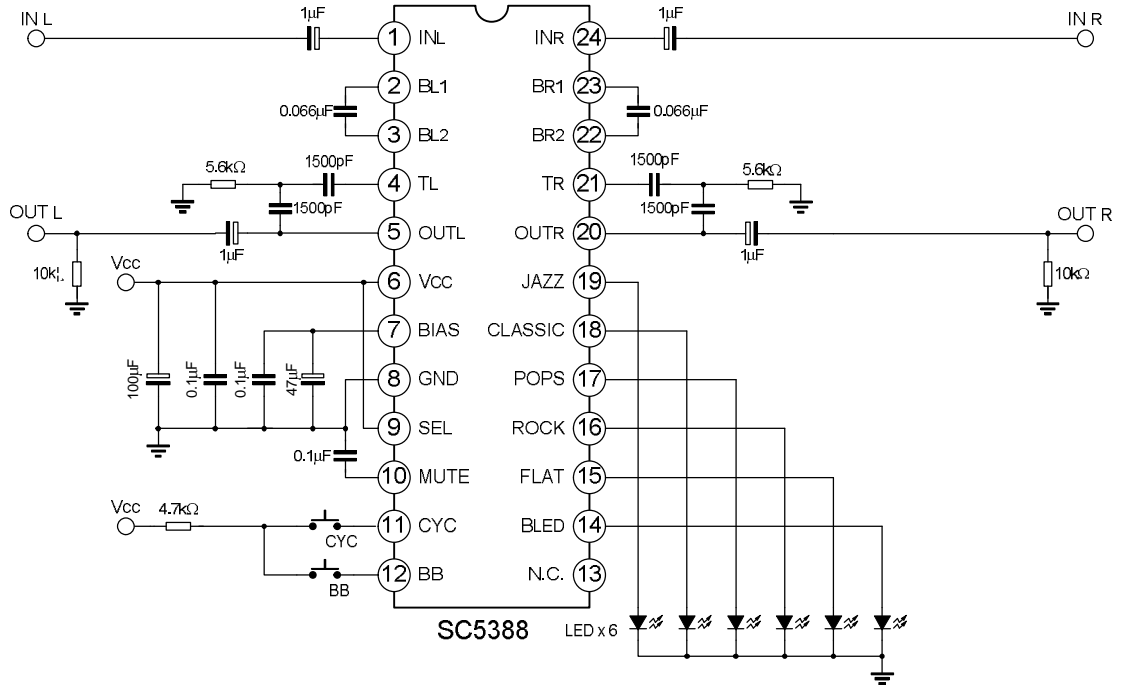

Note: Please use 0.068µF, 1500pF Mylar Capacitors.

PACKAGE OUTLINE

SDIP-24-300-2.54

UNIT: mm

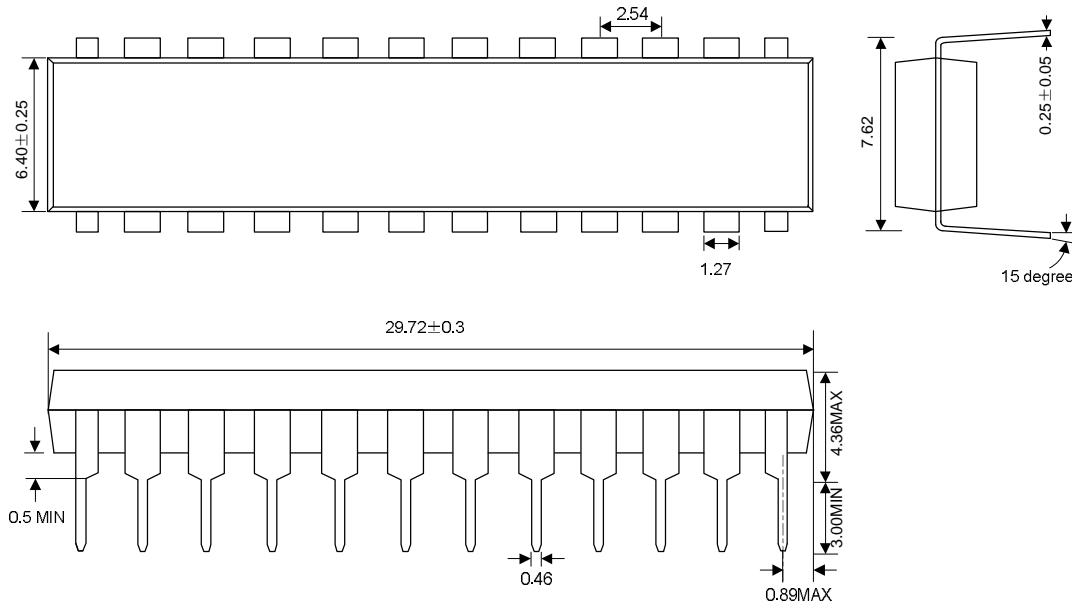

SOP-24-375-1.27

UNIT: mm

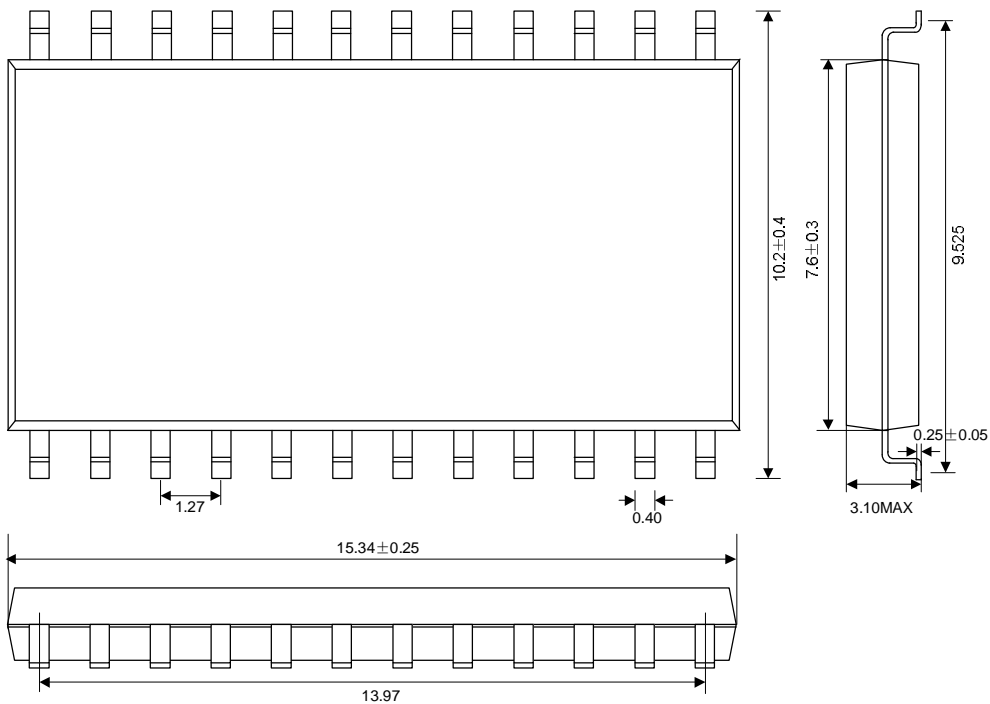



#### HANDLING MOS DEVICES:

Electrostatic charges can exist in many things. All of our MOS devices are internally protected against electrostatic discharge but they can be damaged if the following precautions are not taken:

- Persons at a work bench should be earthed via a wrist strap.
- Equipment cases should be earthed.
- All tools used during assembly, including soldering tools and solder baths, must be earthed.
- MOS devices should be packed for dispatch in antistatic/conductive containers.