

**LA4705**

15 W 2-channel BTL AF Power Amplifier for Car Stereos

Overview

The LA4705 is a BTL two-channel power IC for car audio and radio-cassette players developed in pursuit of excellent sound quality. Low-region frequency characteristics have been improved through the use of a new NF capacitorless circuit, and crosstalk which causes “muddy” sound has been reduced by improving both circuit and pattern layout. As a result, the LA4705 provides powerful bass and clear treble. In addition, the LA4705 features on-chip protectors and standby switch.

Features

- High power: supports total output of 25 W + 25 W ($V_{CC} = 14.4\text{ V}$, THD = 30%, $R_L = 4\ \Omega$)
- Less pop noise
- Designed for excellent sound quality ($f_L < 10\text{ Hz}$, $f_H = 130\text{ kHz}$)
- Any on time settable by external capacitor
- Standby switch circuit on chip (microprocessor supported)
- Various protectors on chip (output-to-ground short/output-to- V_{CC} short/load short/overvoltage/thermal shutdown circuit)
- NF capacitorless
- Supports $R_L = 2\ \Omega$

Specifications

Maximum Ratings at $T_a = 25^\circ\text{C}$

Parameter	Symbol	Conditions	Ratings	Unit
Maximum supply voltage	$V_{CC}\text{ max 1}$	No signal, $t = 60\text{ s}$	24	V
	$V_{CC}\text{ max 2}$	With signal	18	V
Surge supply voltage	$V_{CC}\text{ surge}$	$t \leq 0.2\text{ s}$, single giant pulse	50	V
Allowable power dissipation	$P_d\text{ max}$	Arbitrarily large heat sink	37.5	W
Operating temperature	T_{opr}		-35 to +85	$^\circ\text{C}$
Storage temperature	T_{stg}		-40 to +150	$^\circ\text{C}$

* Set V_{CC} , R_L in a range that does not exceed $P_d\text{ max} = 37.5\text{ W}$

Package Dimensions

unit: mm

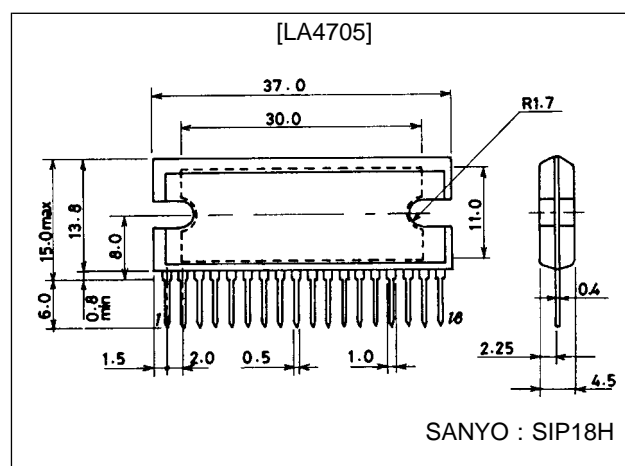
3109-SIP18H

LA4705

Operating Conditions at $T_a = 25^\circ\text{C}$

Parameter	Symbol	Conditions	Ratings	Unit
Recommended supply voltage	V_{CC}		13.2	V
Operating voltage range	$V_{CC\text{ op}}$	Range where $P_d\text{ max}$ is not exceeded	9 to 18	V
Recommended load resistance	R_L		4	Ω

Operating Characteristics at $T_a = 25^\circ\text{C}$, $V_{CC} = 13.2\text{ V}$, $R_L = 4\ \Omega$, $f = 1\text{ kHz}$, $R_g = 600\ \Omega$

Parameter	Symbol	Conditions	min	typ	max	Unit
Quiescent current	I_{CCO}		80	115	250	mA
Standby current	I_{st}			10	60	μA
Voltage gain	VG		38	40	42	dB
Total harmonic distortion	THD	$P_O = 1\text{ W}$		0.1	0.4	%
Output power	P_{O1}	THD = 10%	11	15		W
	P_{O2}	THD = 10%, $V_{CC} = 14.4\text{ V}$		18		W
	P_{O3}	THD = 10%, $R_L = 2\ \Omega$		16		W
Output offset voltage	$V_N\text{ offset}$	$R_g = 0$	-300		+300	mV
Output noise voltage	V_{NO}	$R_g = 0$, B.P.F. = 20 Hz to 20 kHz		0.1	0.5	mVrms
Ripple rejection ratio	SVRR	$R_g = 0$, $f_R = 100\text{ Hz}$, $V_R = 0\text{ dBm}$	40	50		dB
Channel separation	CHsep	$R_g = 10\text{ k}\Omega$, $V_O = 0\text{ dBm}$	50	60		dB
Input resistance	r_i		21	30	39	$\text{k}\Omega$
Standby pin applied voltage	V_{st}	Amp on, applied through 10 $\text{k}\Omega$	2.5		V_{CC}	V

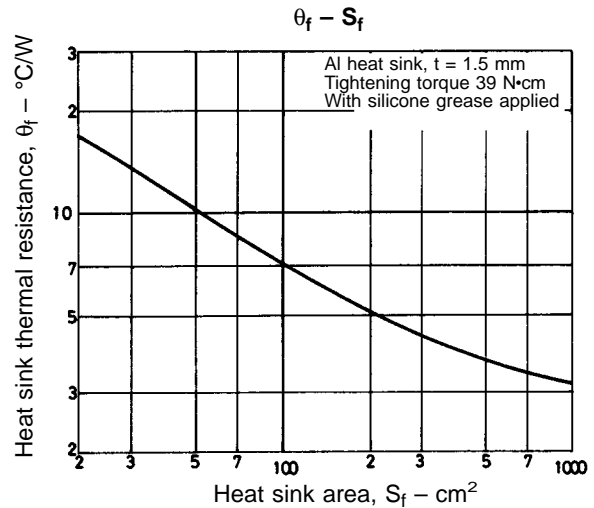
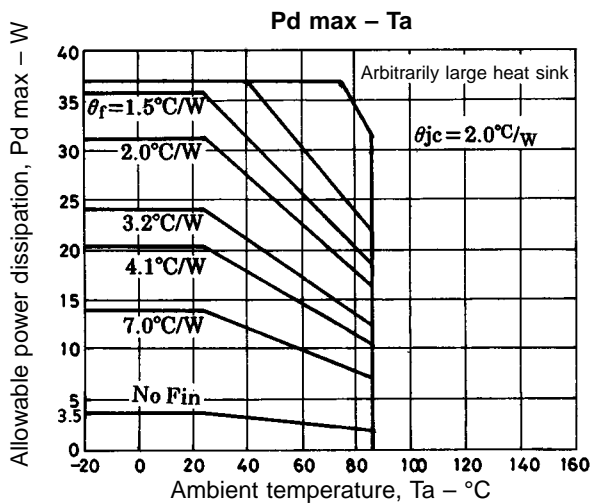

LA4705

Features and Usage Notes

- Pin 5 is the standby switch pin. The amplifier is turned on by applying approximately 2 V or more to this pin through an external resistor (R1). The current flowing into pin 5 is 500 μ A or less.
- Pin 6 is the mute pin. The amplifier on time can be set as desired through C3. By grounding pin 6, the amplifier can implement mute operation. In this case, the recovery time depends on C3.
- In order to prevent damage or degradation which may be caused by abnormally heated IC, the LA4705 has a thermal shutdown protector. Accordingly, in the case of inadequate heat dissipation, the thermal shutdown protector will operate to control the output gradually into attenuation.
- Also be fully careful of handling other protectors built in the LA4705.

Sample Application Circuit

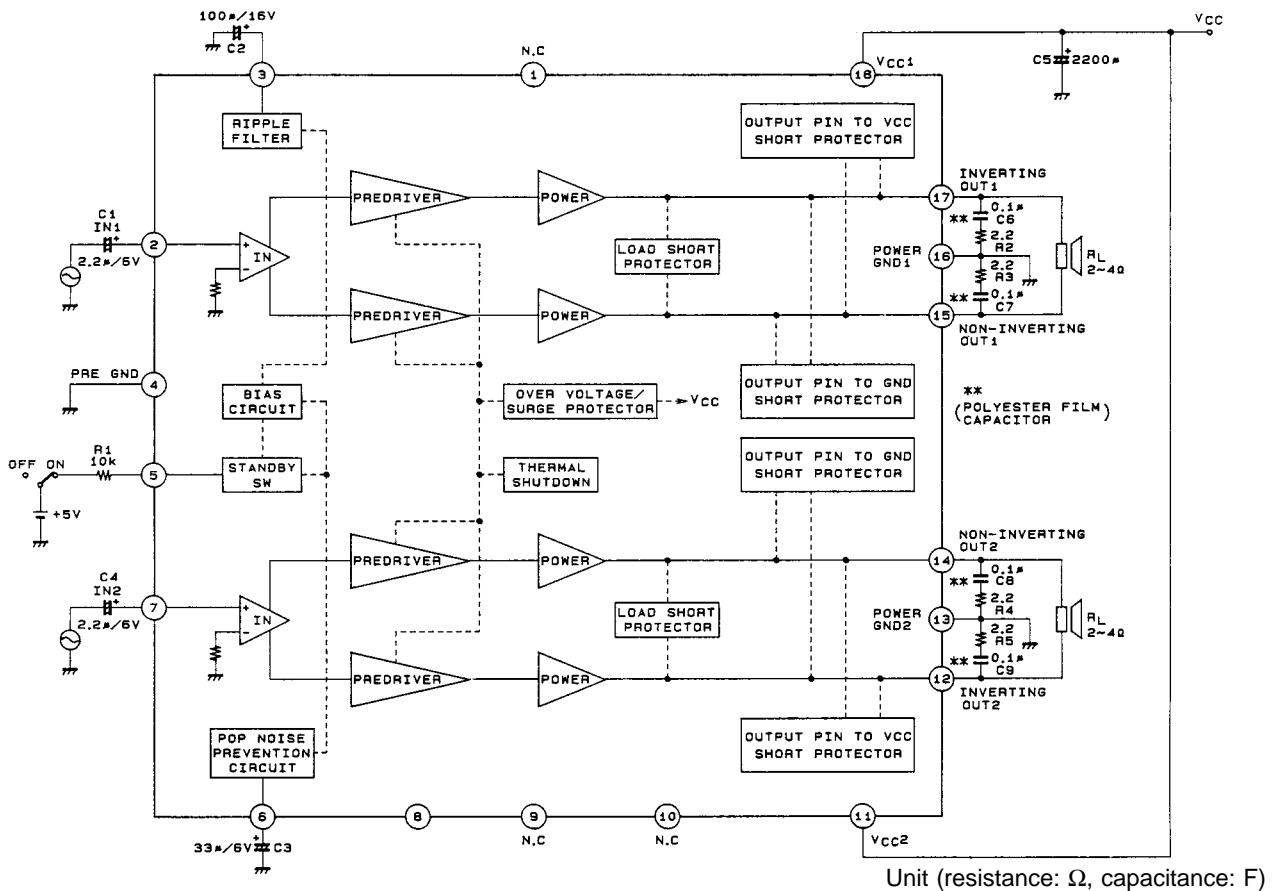

1,9,10pin: Non connect.
8pin: Don't use.

A00860

Sample Print Pattern

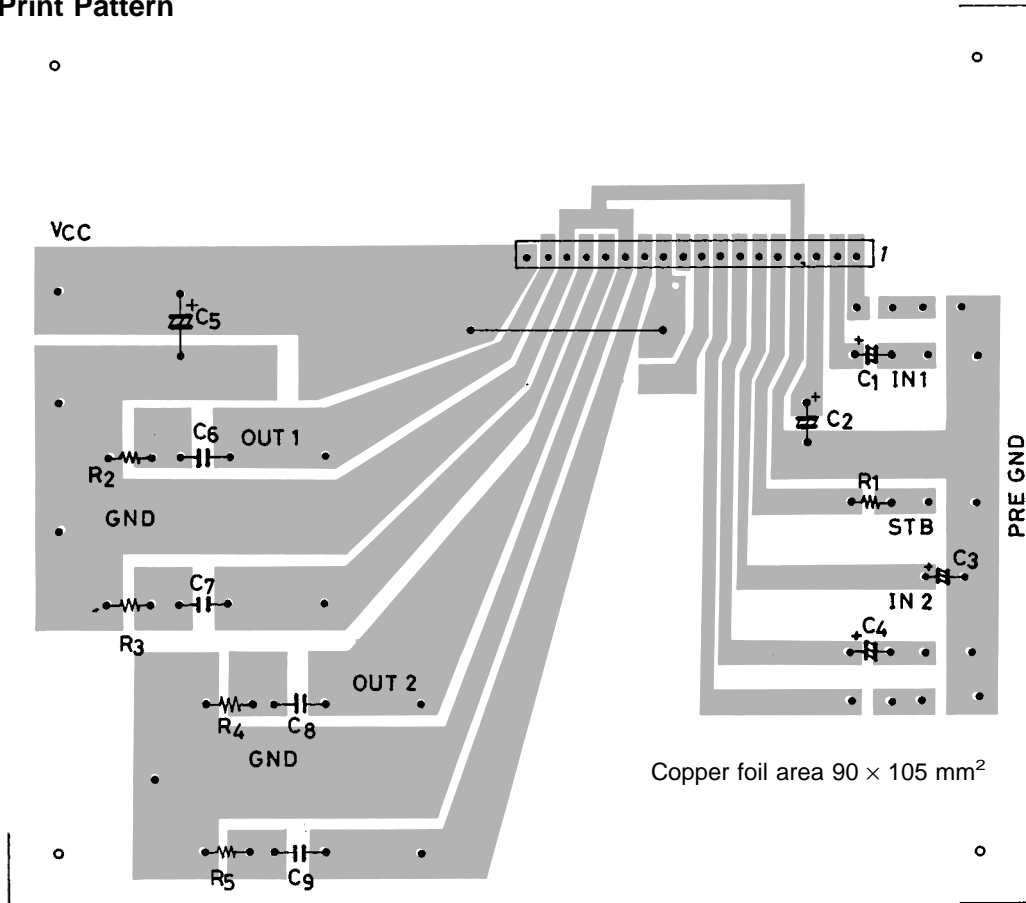

Description of External Components

C1, C4	Input capacitors	2.2 μ F is recommended. f_L can be varied by C1, C4 capacitances to adjust the bass range.
C2	Decoupling capacitor (ripple filter)	
C3	Amplifier on time setting capacitor	Approximately 0.6 to 0.7 second for 33 μ F. Since the on time is proportional to this capacitance, it can be set as desired by varying this capacitance. The amplifier can implement mute operation by setting C3 to GND potential.
C5	Power supply capacitor	
C6, C7, C8, C9	Oscillation blocking capacitors	Use polyester film capacitors (Mylar capacitors) with good temperature characteristics. (R2, R3, R4, and R5 used jointly.) Since stability may be affected slightly by the pattern layout, etc., 0.1 μ F or more is recommended.
R1	Standby switch current limiting resistor	10 k Ω is recommended. This resistor cannot be removed.

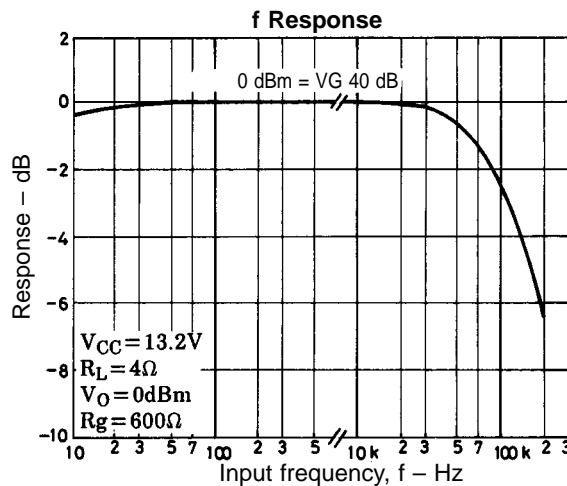
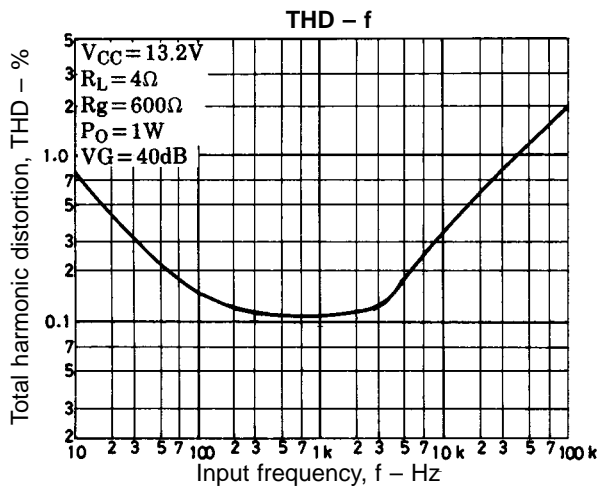
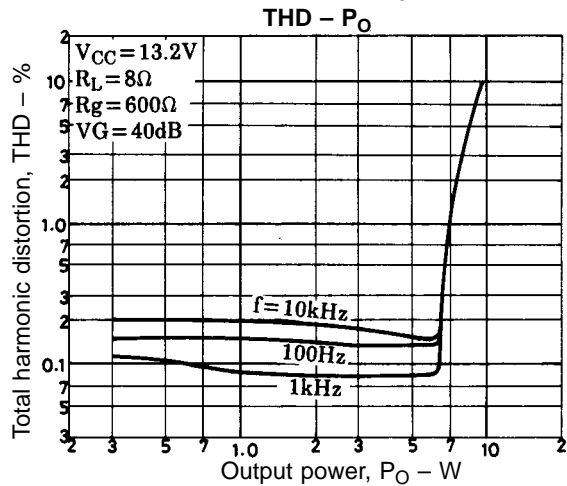
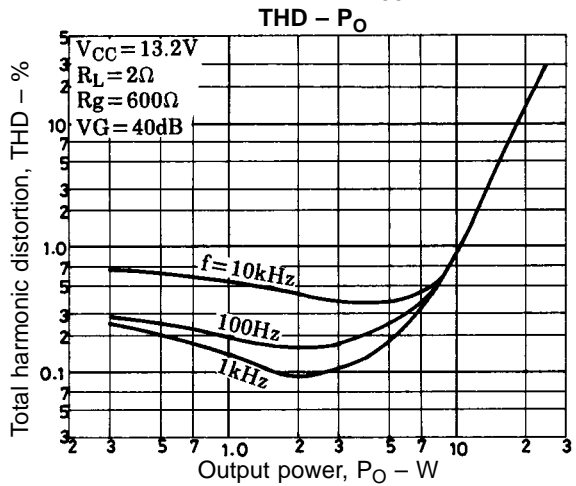
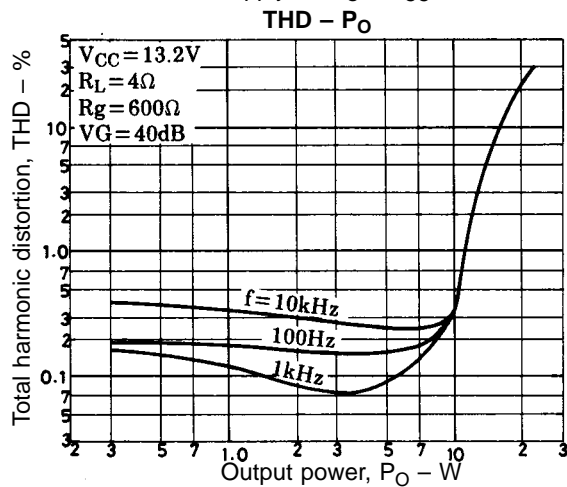
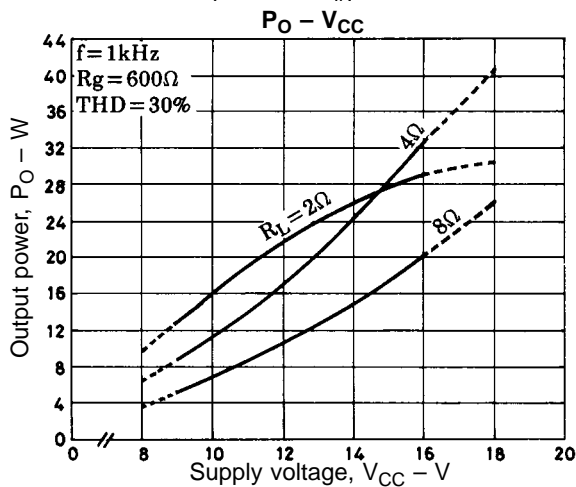
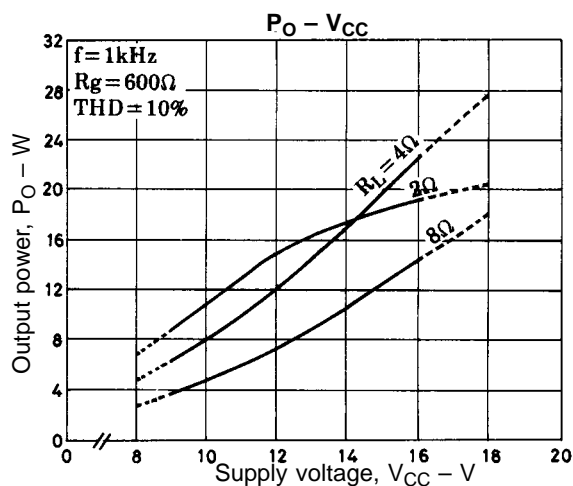
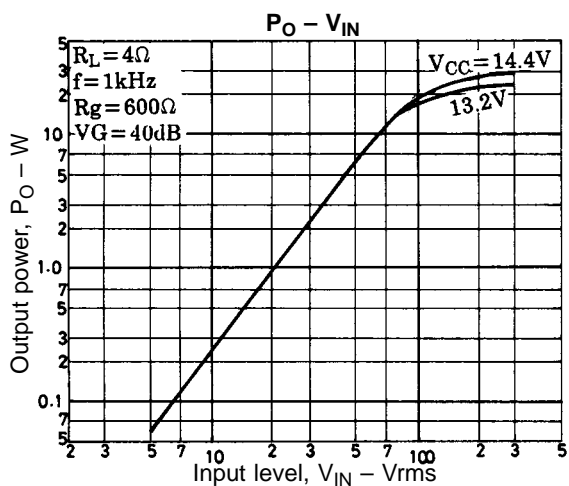

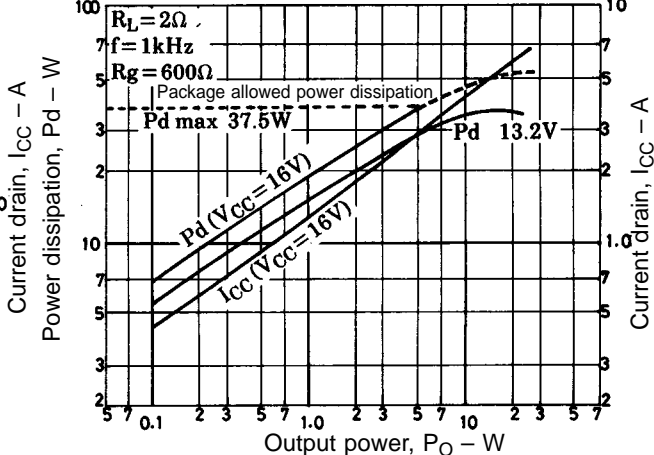
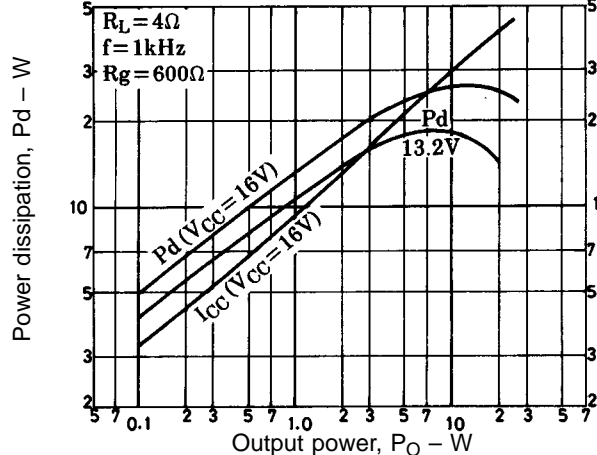
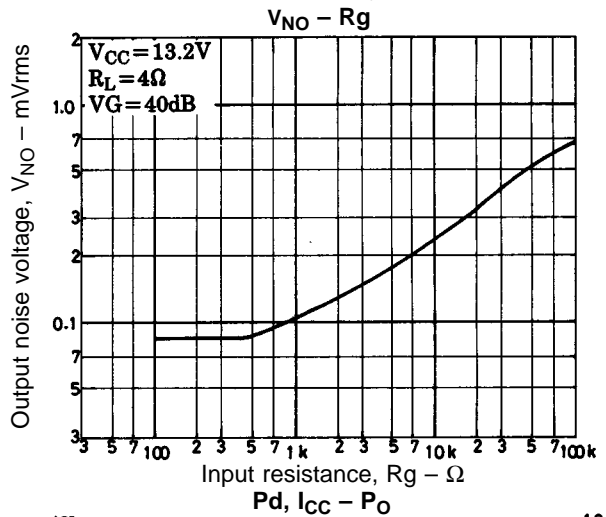
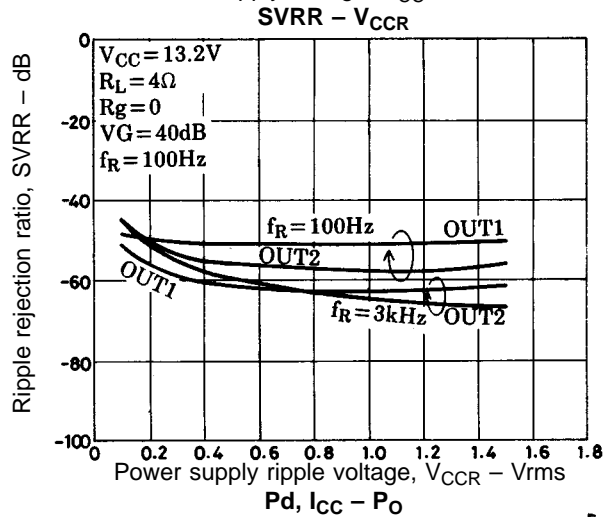
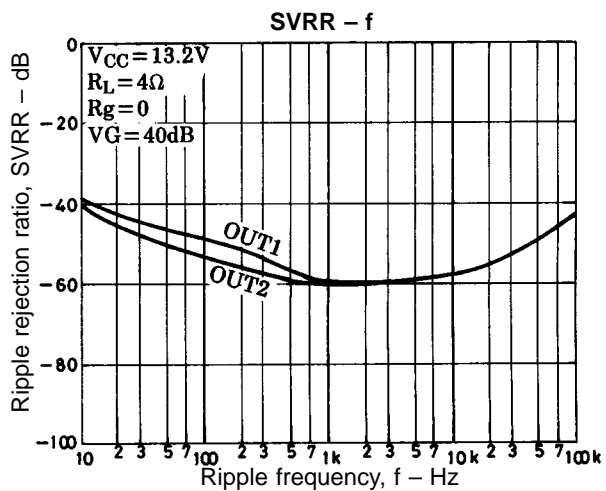
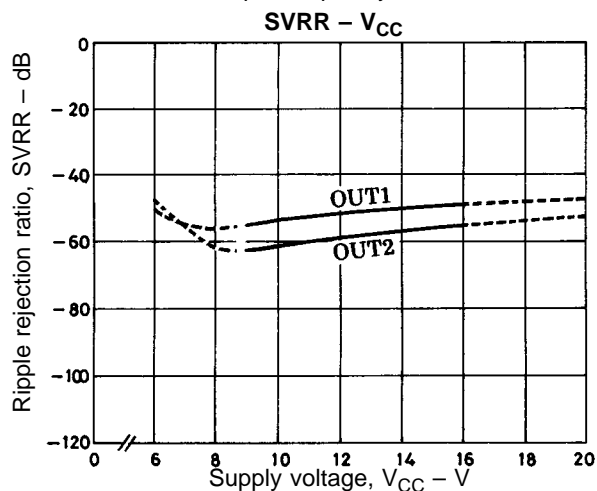
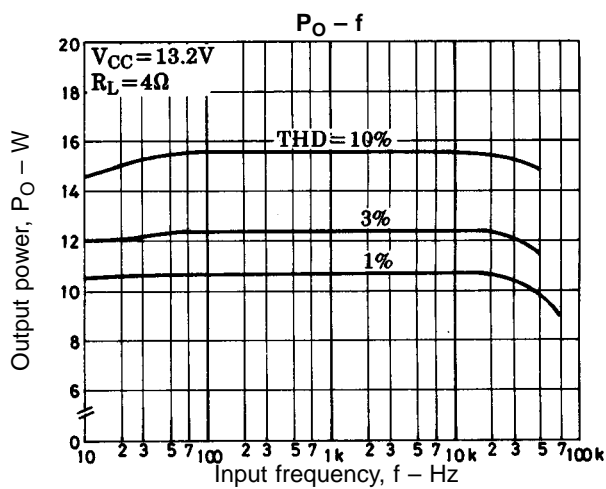
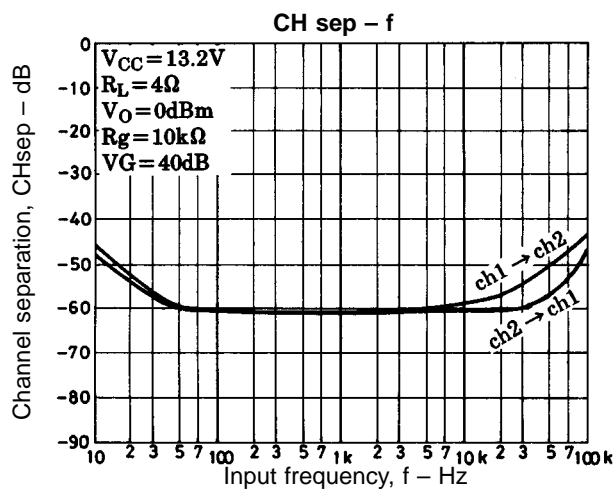

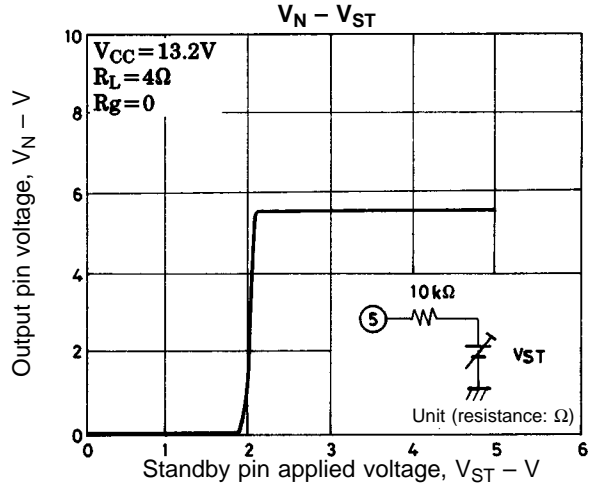
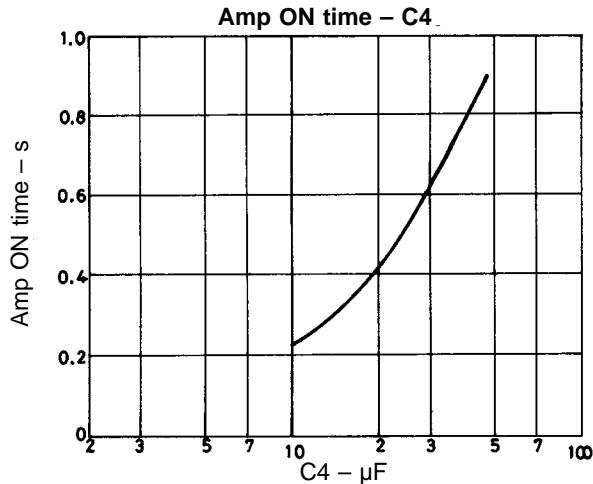
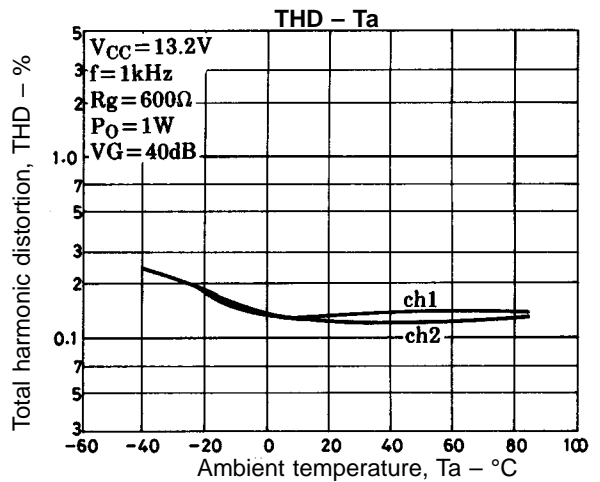
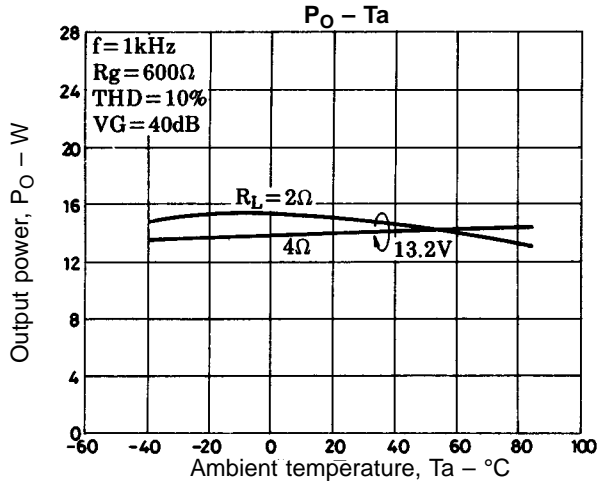
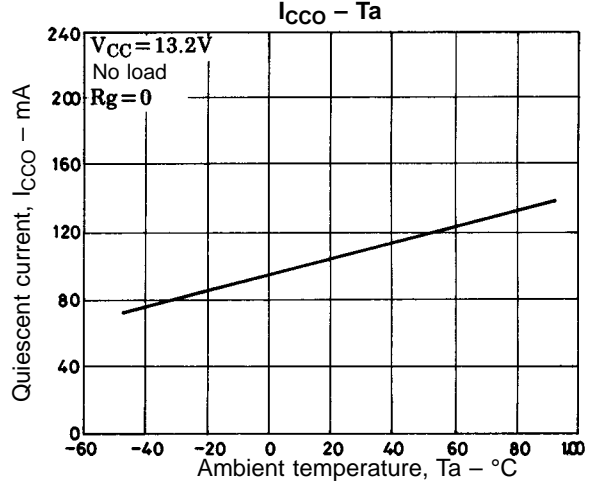
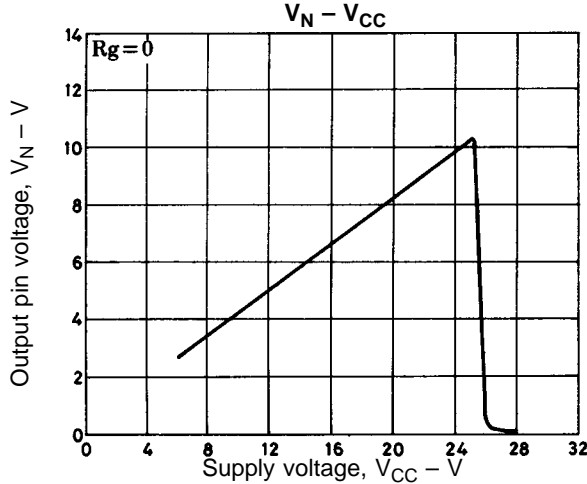
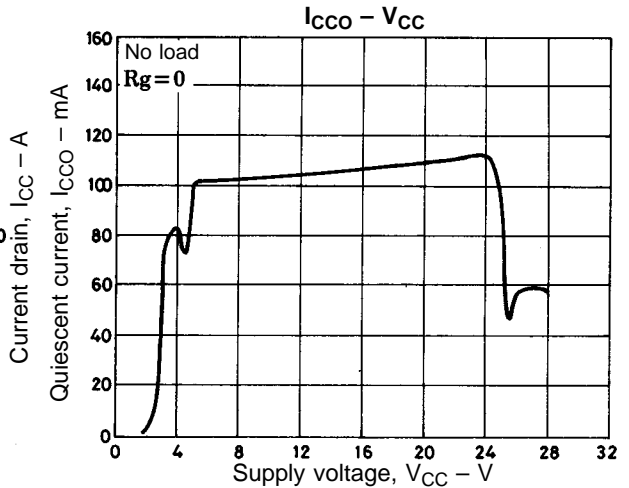
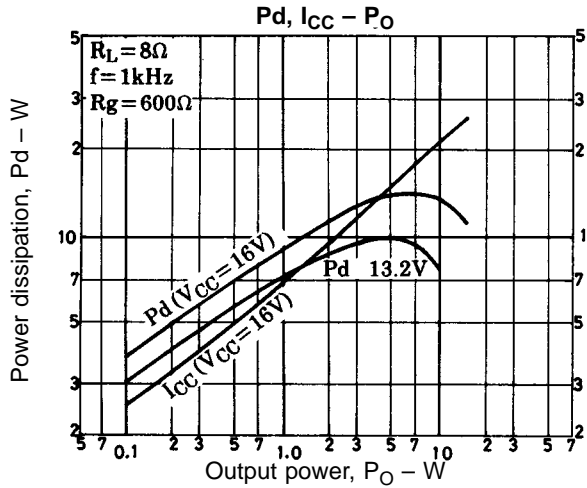

BTL output DC locus

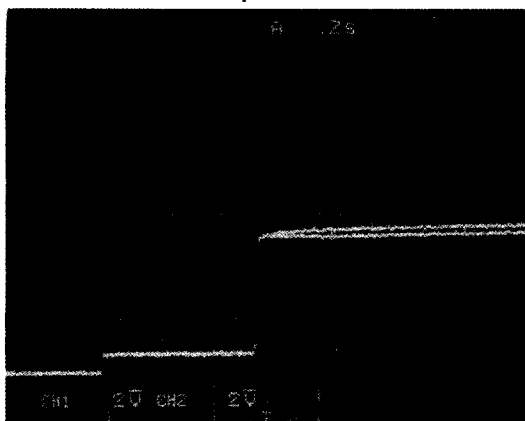

Power ON

AC Level

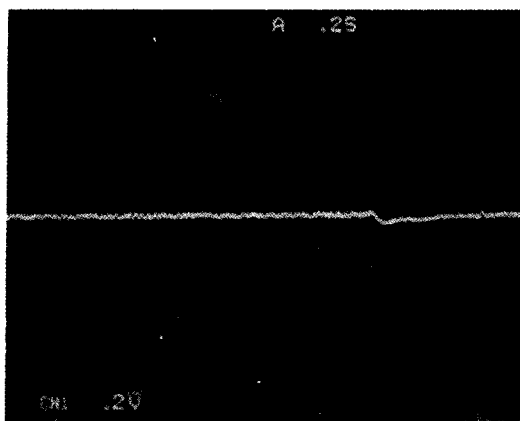

Locus when ON

Power ON
 $V_{CC} = 13.2V$
 $R_L = 4\Omega$
 $R_g = 0$

BTL output DC locus

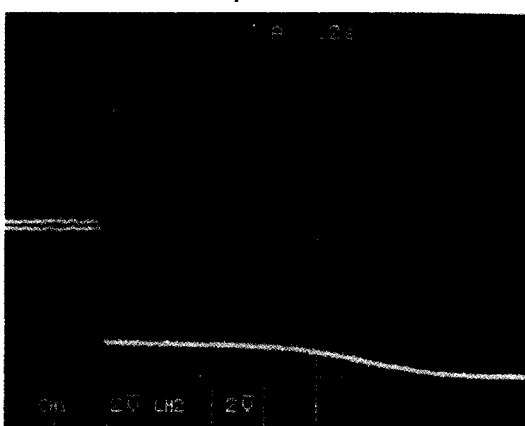

Standby OFF

AC Level

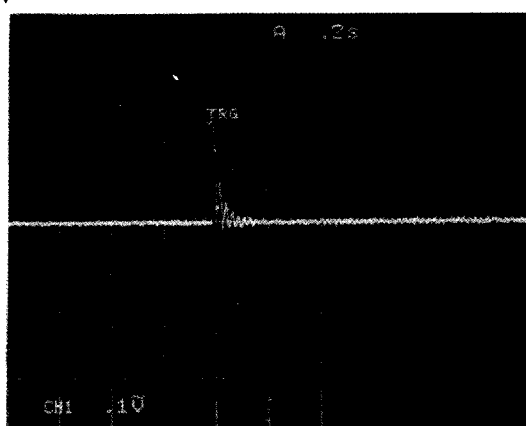

Locus when OFF

Standby SW OFF
 $V_{CC} = 13.2V$
 $R_L = 4\Omega$
 $R_g = 0$

- No products described or contained herein are intended for use in surgical implants, life-support systems, aerospace equipment, nuclear power control systems, vehicles, disaster/crime-prevention equipment and the like, the failure of which may directly or indirectly cause injury, death or property loss.
- Anyone purchasing any products described or contained herein for an above-mentioned use shall:
 - ① Accept full responsibility and indemnify and defend SANYO ELECTRIC CO., LTD., its affiliates, subsidiaries and distributors and all their officers and employees, jointly and severally, against any and all claims and litigation and all damages, cost and expenses associated with such use:
 - ② Not impose any responsibility for any fault or negligence which may be cited in any such claim or litigation on SANYO ELECTRIC CO., LTD., its affiliates, subsidiaries and distributors or any of their officers and employees jointly or severally.
- Information (including circuit diagrams and circuit parameters) herein is for example only; it is not guaranteed for volume production. SANYO believes information herein is accurate and reliable, but no guarantees are made or implied regarding its use or any infringements of intellectual property rights or other rights of third parties.

This catalog provides information as of December, 1996. Specifications and information herein are subject to change without notice.