

# LM324/LM324A, LM2902/LM2902A

## Quad Operational Amplifier

### Features

- Internally Frequency Compensated for Unity Gain
- Large DC Voltage Gain: 100dB
- Wide Power Supply Range:  
LM324/LM324A : 3V~32V (or  $\pm 1.5 \sim 16V$ )  
LM2902/LM2902A: 3V~26V (or  $\pm 1.5V \sim 13V$ )
- Input Common Mode Voltage Range Includes Ground
- Large Output Voltage Swing: 0V to VCC -1.5V
- Power Drain Suitable for Battery Operation

### Description

The LM324/LM324A, LM2902/LM2902A consist of four independent, high gain, internally frequency compensated operational amplifiers which were designed specifically to operate from a single power supply over a wide voltage range. operation from split power supplies is also possible so long as the difference between the two supplies is 3 volts to 32 volts. Application areas include transducer amplifier, DC gain blocks and all the conventional OP Amp circuits which now can be easily implemented in single power supply systems.

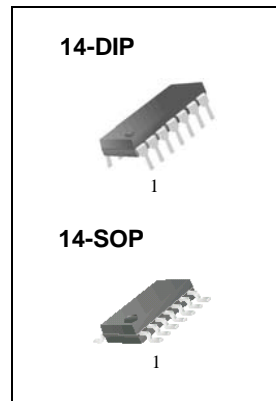

### Internal Block Diagram

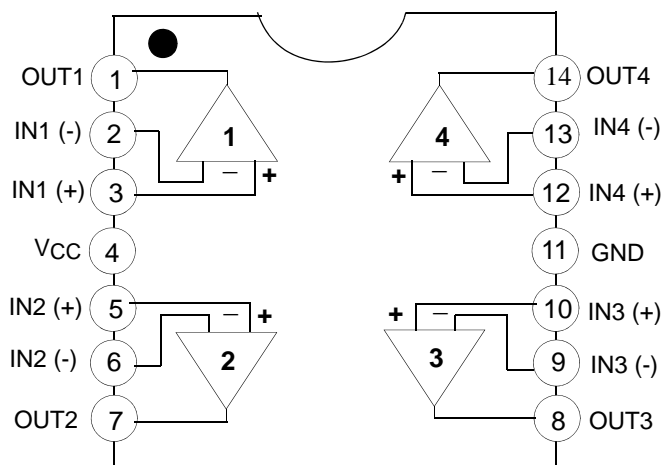

## Schematic Diagram

(One Section Only)

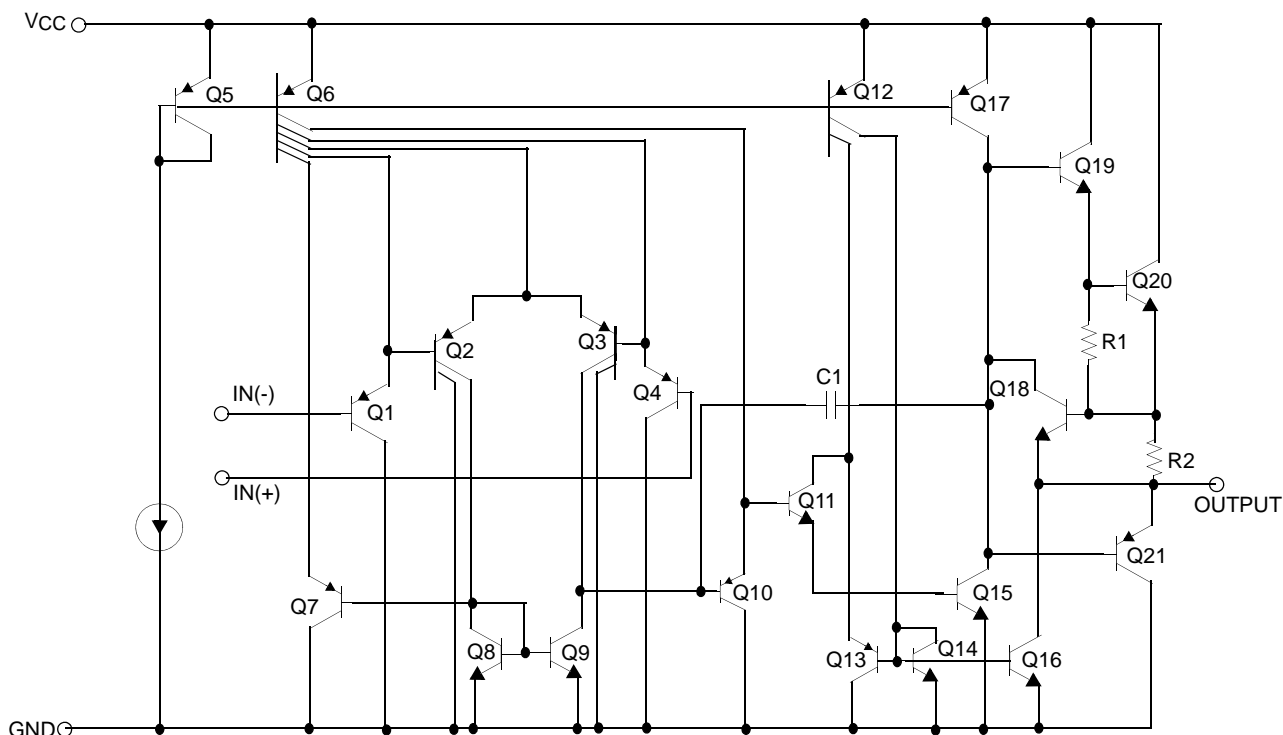

## Absolute Maximum Ratings

Parameter	Symbol	LM324/LM324A	LM2902/LM2902A	Unit
Power Supply Voltage	V <sub>CC</sub>	±16 or 32	±13 or 26	V
Differential Input Voltage	V <sub>I(DIFF)</sub>	32	26	V
Input Voltage	V <sub>I</sub>	-0.3 to +32	-0.3 to +26	V
Output Short Circuit to GND V <sub>CC</sub> ≤ 15V, T <sub>A</sub> = 25°C (one Amp)	-	Continuous	Continuous	-
Power Dissipation, T <sub>A</sub> = 25°C 14-DIP 14-SOP	P <sub>D</sub>	1310 640	1310 640	mW
Operating Temperature Range	T <sub>OPR</sub>	0 ~ +70	-40 ~ +85	°C
Storage Temperature Range	T <sub>STG</sub>	-65 ~ +150	-65 ~ +150	°C

## Thermal Data

Parameter	Symbol	Value	Unit
Thermal Resistance Junction-Ambient Max. 14-DIP 14-SOP	R <sub>θja</sub>	95 195	°C/W

## Electrical Characteristics

( $V_{CC} = 5.0V$ ,  $V_{EE} = GND$ ,  $T_A = 25^\circ C$ , unless otherwise specified)

Parameter	Symbol	Conditions	LM324			LM2902			Unit	
			Min.	Typ.	Max.	Min.	Typ.	Max.		
Input Offset Voltage	$V_{IO}$	$V_{CM} = 0V$ to $V_{CC} - 1.5V$ $V_{O(P)} = 1.4V$ , $R_S = 0\Omega$ (Note1)	-	1.5	7.0	-	1.5	7.0	mV	
Input Offset Current	$I_{IO}$	$V_{CM} = 0V$	-	3.0	50	-	3.0	50	nA	
Input Bias Current	$I_{BIAS}$	$V_{CM} = 0V$	-	40	250	-	40	250	nA	
Input Common-Mode Voltage Range	$V_{I(R)}$	Note1	0	-	$V_{CC} - 1.5$	0	-	$V_{CC} - 1.5$	V	
Supply Current	$I_{CC}$	$R_L = \infty$ , $V_{CC} = 30V$ (LM2902, $V_{CC} = 26V$ )	-	1.0	3	-	1.0	3	mA	
		$R_L = \infty$ , $V_{CC} = 5V$	-	0.7	1.2	-	0.7	1.2	mA	
Large Signal Voltage Gain	$G_V$	$V_{CC} = 15V$ , $R_L = 2k\Omega$ $V_{O(P)} = 1V$ to $11V$	25	100	-	25	100	-	V/mV	
Output Voltage Swing	$V_{O(H)}$	Note1	$R_L = 2k\Omega$	26	-	-	22	-	-	V
			$R_L = 10k\Omega$	27	28	-	23	24	-	V
	$V_{O(L)}$	$V_{CC} = 5V$ , $R_L = 10k\Omega$	-	5	20	-	5	100	mV	
Common-Mode Rejection Ratio	CMRR	-	65	75	-	50	75	-	dB	
Power Supply Rejection Ratio	PSRR	-	65	100	-	50	100	-	dB	
Channel Separation	CS	$f = 1kHz$ to $20kHz$ (Note2)	-	120	-	-	120	-	dB	
Short Circuit to GND	ISC	$V_{CC} = 15V$	-	40	60	-	40	60	mA	
Output Current	ISOURCE	$V_{I(+)} = 1V$ , $V_{I(-)} = 0V$ $V_{CC} = 15V$ , $V_{O(P)} = 2V$	20	40	-	20	40	-	mA	
		$V_{I(+)} = 0V$ , $V_{I(-)} = 1V$ $V_{CC} = 15V$ , $V_{O(P)} = 2V$	10	13	-	10	13	-	mA	
	ISINK	$V_{I(+)} = 0V$ , $V_{I(-)} = 1V$ $V_{CC} = 15V$ , $V_{O(R)} = 200mV$	12	45	-	-	-	-	$\mu A$	
Differential Input Voltage	$V_{I(DIFF)}$	-	-	-	$V_{CC}$	-	-	$V_{CC}$	V	

### Note :

- $V_{CC} = 30V$  for LM324,  $V_{CC} = 26V$  for LM2902
- This parameter, although guaranteed, is not 100% tested in production.

**Electrical Characteristics** (Continued)

(VCC = 5.0V, VEE = GND, unless otherwise specified)

The following specification apply over the range of  $0^{\circ}\text{C} \leq T_A \leq +70^{\circ}\text{C}$  for the LM324 ; and the  $-40^{\circ}\text{C} \leq T_A \leq +85^{\circ}\text{C}$  for the LM2902

Parameter	Symbol	Conditions	LM324			LM2902			Unit	
			Min.	Typ.	Max.	Min.	Typ.	Max.		
Input Offset Voltage	$V_{IO}$	$V_{ICM} = 0\text{V}$ to $V_{CC} - 1.5\text{V}$ $V_{O(P)} = 1.4\text{V}$ , $R_S = 0\Omega$ (Note1)	-	-	9.0	-	-	10.0	mV	
Input Offset Voltage Drift	$\Delta V_{IO}/\Delta T$	$R_S = 0\Omega$ (Note2)	-	7.0	-	-	7.0	-	$\mu\text{V}/^{\circ}\text{C}$	
Input Offset Current	$I_{IO}$	$V_{CM} = 0\text{V}$	-	-	150	-	-	200	nA	
Input Offset Current Drift	$\Delta I_{IO}/\Delta T$	$R_S = 0\Omega$ (Note2)	-	10	-	-	10	-	$\text{pA}/^{\circ}\text{C}$	
Input Bias Current	$I_{BIAS}$	$V_{CM} = 0\text{V}$	-	-	500	-	-	500	nA	
Input Common-Mode Voltage Range	$V_{I(R)}$	Note1	0	-	$V_{CC} - 2.0$	0	-	$V_{CC} - 2.0$	V	
Large Signal Voltage Gain	$G_V$	$V_{CC} = 15\text{V}$ , $R_L = 2.0\text{k}\Omega$ $V_{O(P)} = 1\text{V}$ to $11\text{V}$	15	-	-	15	-	-	V/mV	
Output Voltage Swing	$V_{O(H)}$	Note1	$R_L = 2\text{k}\Omega$	26	-	-	22	-	-	V
			$R_L = 10\text{k}\Omega$	27	28	-	23	24	-	V
	$V_{O(L)}$	$V_{CC} = 5\text{V}$ , $R_L = 10\text{k}\Omega$	-	5	20	-	5	100	mV	
Output Current	ISOURCE	$V_{I(+)} = 1\text{V}$ , $V_{I(-)} = 0\text{V}$ $V_{CC} = 15\text{V}$ , $V_{O(P)} = 2\text{V}$	10	20	-	10	20	-	mA	
	ISINK	$V_{I(+)} = 0\text{V}$ , $V_{I(-)} = 1\text{V}$ $V_{CC} = 15\text{V}$ , $V_{O(P)} = 2\text{V}$	5	8	-	5	8	-	mA	
Differential Input Voltage	$V_{I(DIFF)}$	-	-	-	$V_{CC}$	-	-	$V_{CC}$	V	

**Note:**

1.  $V_{CC} = 30\text{V}$  for LM324 ,  $V_{CC} = 26\text{V}$  for LM2902
2. These parameters, although guaranteed, are not 100% tested in production.

**Electrical Characteristics** (Continued)(V<sub>CC</sub> = 5.0V, V<sub>EE</sub> = GND, T<sub>A</sub> = 25°C, unless otherwise specified)

Parameter	Symbol	Conditions	LM324A			LM2902A			Unit	
			Min.	Typ.	Max.	Min.	Typ.	Max.		
Input Offset Voltage	V <sub>IO</sub>	V <sub>CM</sub> = 0V to V <sub>CC</sub> -1.5V V <sub>O(P)</sub> = 1.4V, R <sub>S</sub> = 0Ω (Note1)	-	1.5	3.0	-	1.5	2.0	mV	
Input Offset Current	I <sub>IO</sub>	V <sub>CM</sub> = 0V	-	3.0	30	-	3.0	50	nA	
Input Bias Current	I <sub>BIAS</sub>	V <sub>CM</sub> = 0V	-	40	100	-	40	250	nA	
Input Common-Mode Voltage Range	V <sub>I(R)</sub>	V <sub>CC</sub> = 30V	0	-	V <sub>CC</sub> -1.5	0	-	V <sub>CC</sub> -1.5	V	
Supply Current	I <sub>CC</sub>	V <sub>CC</sub> = 30V, R <sub>L</sub> = ∞ (LM2902, V <sub>CC</sub> =26V)	-	1.5	3	-	1.0	3	mA	
		V <sub>CC</sub> = 5V, R <sub>L</sub> = ∞	-	0.7	1.2	-	0.7	1.2	mA	
Large Signal Voltage Gain	G <sub>V</sub>	V <sub>CC</sub> = 15V, R <sub>L</sub> = 2kΩ V <sub>O(P)</sub> = 1V to 11V	25	100	-	25	100	-	V/mV	
Output Voltage Swing	V <sub>O(H)</sub>	Note1	R <sub>L</sub> = 2kΩ	26	-	-	22	-	-	V
			R <sub>L</sub> = 10kΩ	27	28	-	23	24	-	V
	V <sub>O(L)</sub>	V <sub>CC</sub> = 5V, R <sub>L</sub> = 10kΩ	-	5	20	-	5	100	mV	
Common-Mode Rejection Ratio	CMRR	-	65	85	-	50	75	-	dB	
Power Supply Rejection Ratio	PSRR	-	65	100	-	50	100	-	dB	
Channel Separation	CS	f = 1kHz to 20kHz (Note2)	-	120	-	-	120	-	dB	
Short Circuit to GND	I <sub>SC</sub>	V <sub>CC</sub> = 15V	-	40	60	-	40	60	mA	
Output Current	I <sub>SOURCE</sub>	V <sub>I(+)</sub> = 1V, V <sub>I(-)</sub> = 0V V <sub>CC</sub> = 15V, V <sub>O(P)</sub> = 2V	20	40	-	20	40	-	mA	
		V <sub>I(+)</sub> = 0V, V <sub>I(-)</sub> = 1V V <sub>CC</sub> = 15V, V <sub>O(P)</sub> = 2V	10	20	-	10	13	-	mA	
	I <sub>SINK</sub>	V <sub>I(+)</sub> = 0V, V <sub>I(-)</sub> = 1V V <sub>CC</sub> = 15V, V <sub>O(P)</sub> = 200mV	12	50	-	-	-	-	μA	
Differential Input Voltage	V <sub>I(DIFF)</sub>	-	-	-	V <sub>CC</sub>	-	-	V <sub>CC</sub>	V	

**Note:**

- V<sub>CC</sub>=30V for LM324A ; V<sub>CC</sub>=26V for LM2902A
- This parameter, although guaranteed, is not 100% tested in production.

**Electrical Characteristics** (Continued)(V<sub>CC</sub> = 5.0V, V<sub>EE</sub> = GND, unless otherwise specified)The following specification apply over the range of 0°C ≤ T<sub>A</sub> ≤ +70°C for the LM324A ; and the -40°C ≤ T<sub>A</sub> ≤ +85°C for the LM2902A

Parameter	Symbol	Conditions	LM324A			LM2902A			Unit	
			Min.	Typ.	Max.	Min.	Typ.	Max.		
Input Offset Voltage	V <sub>IO</sub>	V <sub>CM</sub> = 0V to V <sub>CC</sub> -1.5V V <sub>O(P)</sub> = 1.4V, R <sub>S</sub> = 0Ω (Note1)	-	-	5.0	-	-	6.0	mV	
Input Offset Voltage Drift	ΔV <sub>IO</sub> /ΔT	R <sub>S</sub> = 0Ω (Note2)	-	7.0	30	-	7.0	-	μV/°C	
Input Offset Current	I <sub>IO</sub>	V <sub>CM</sub> = 0V	-	-	75	-	-	200	nA	
Input Offset Current Drift	ΔI <sub>IO</sub> /ΔT	R <sub>S</sub> = 0Ω (Note2)	-	10	300	-	10	-	pA/°C	
Input Bias Current	I <sub>BIAS</sub>	-	-	40	200	-	-	500	nA	
Input Common-Mode Voltage Range	V <sub>I(R)</sub>	Note1	0	-	V <sub>CC</sub> -2.0	0	-	V <sub>CC</sub> -2.0	V	
Large Signal Voltage Gain	G <sub>V</sub>	V <sub>CC</sub> = 15V, R <sub>L</sub> = 2.0kΩ	15	-	-	15	-	-	V/mV	
Output Voltage Swing	V <sub>O(H)</sub>	Note1	R <sub>L</sub> = 2kΩ	26	-	-	22	-	-	V
			R <sub>L</sub> = 10kΩ	27	28	-	23	24	-	V
	V <sub>O(L)</sub>	V <sub>CC</sub> = 5V, R <sub>L</sub> = 10kΩ	-	5	20	-	5	100	mV	
Output Current	I <sub>SOURCE</sub>	V <sub>I(+)</sub> = 1V, V <sub>I(-)</sub> = 0V V <sub>CC</sub> = 15V, V <sub>O(P)</sub> = 2V	10	20	-	10	20	-	mA	
	I <sub>SINK</sub>	V <sub>I(+)</sub> = 0V, V <sub>I(-)</sub> = 1V V <sub>CC</sub> = 15V, V <sub>O(P)</sub> = 2V	5	8	-	5	8	-	mA	
Differential Input Voltage	V <sub>I(DIFF)</sub>	-	-	-	V <sub>CC</sub>	-	-	V <sub>CC</sub>	V	

**Note:**1. V<sub>CC</sub>=30V for LM324A ; V<sub>CC</sub>=26V for LM2902A.

2. These parameters, although guaranteed, are not 100% tested in production.

# Typical Performance Characteristics

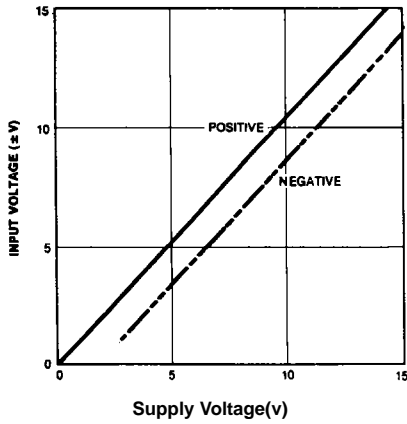

Figure 1. Input Voltage Range vs Supply Voltage

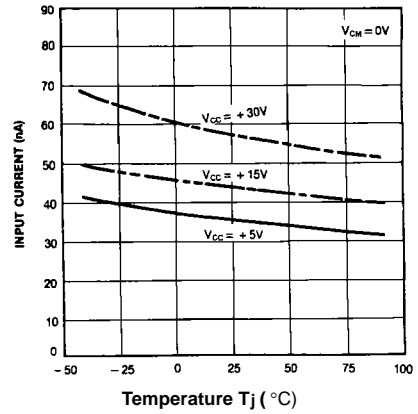

Figure 2. Input Current vs Temperature

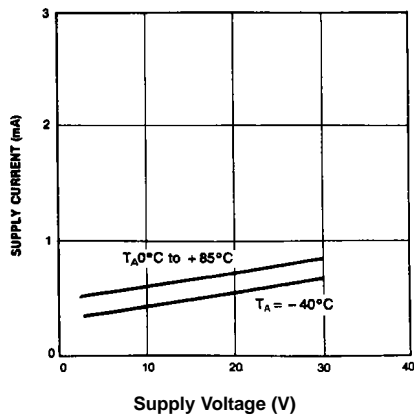

Figure 3. Supply Current vs Supply Voltage

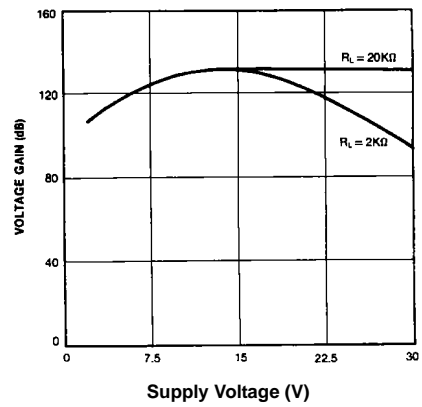

Figure 4. Voltage Gain vs Supply Voltage

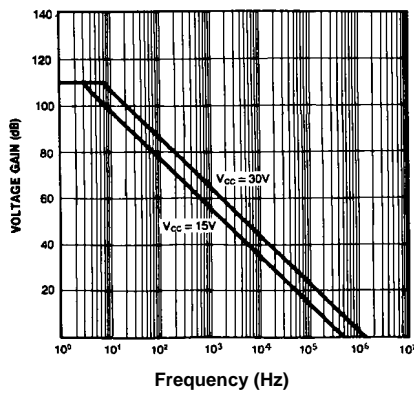

Figure 5. Open Loop Frequency Response

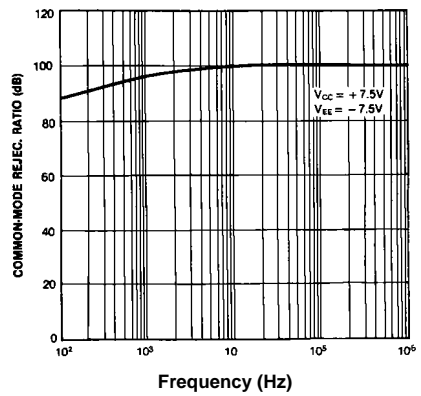

Figure 6. Common mode Rejection Ratio

Typical Performance Characteristics (Continued)

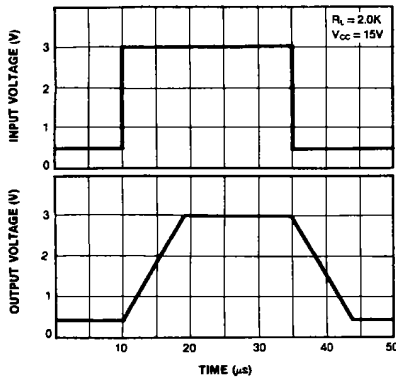

Figure 7. Voltage Follower Pulse Response

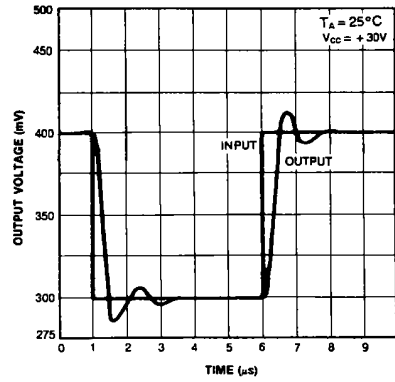

Figure 8. Voltage Follower Pulse Response (Small Signal)

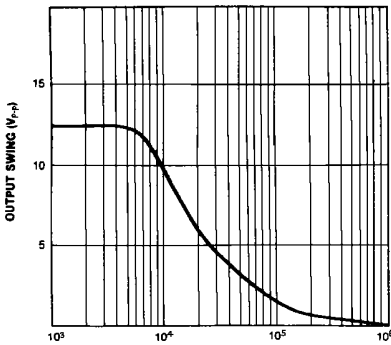

Figure 9. Large Signal Frequency Response

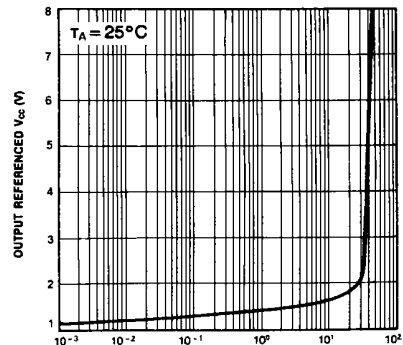

Figure 10. Output Characteristics vs Current Sourcing

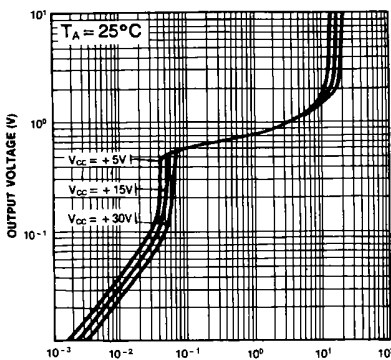

Figure 11. Output Characteristics vs Current Sinking

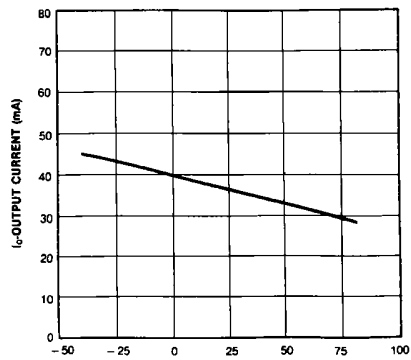

Figure 12. Current Limiting vs Temperature



# Mechanical Dimensions

## Package

Dimensions in millimeters

### 14-DIP

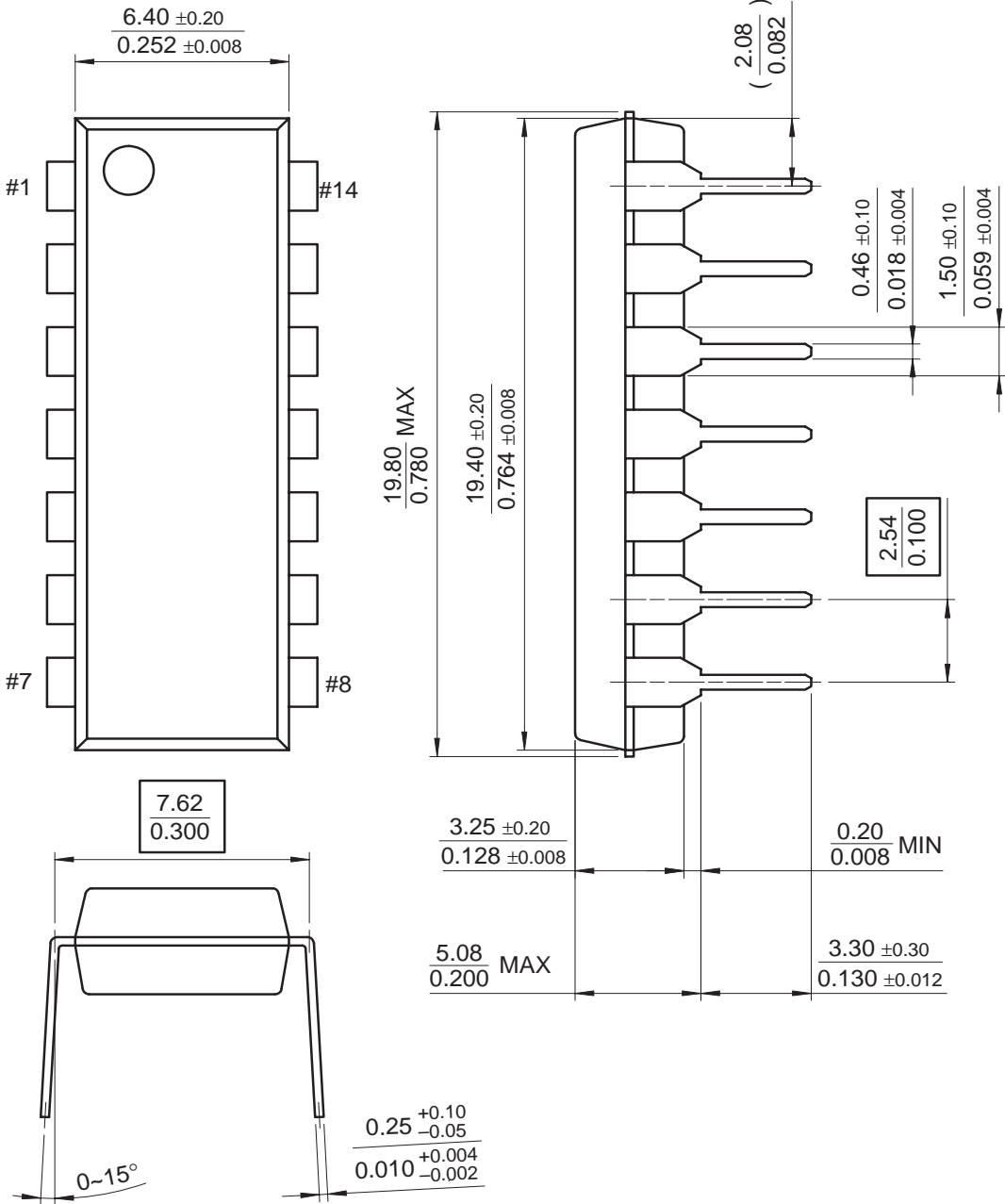

# Mechanical Dimensions (Continued)

## Package

Dimensions in millimeters

### 14-SOP

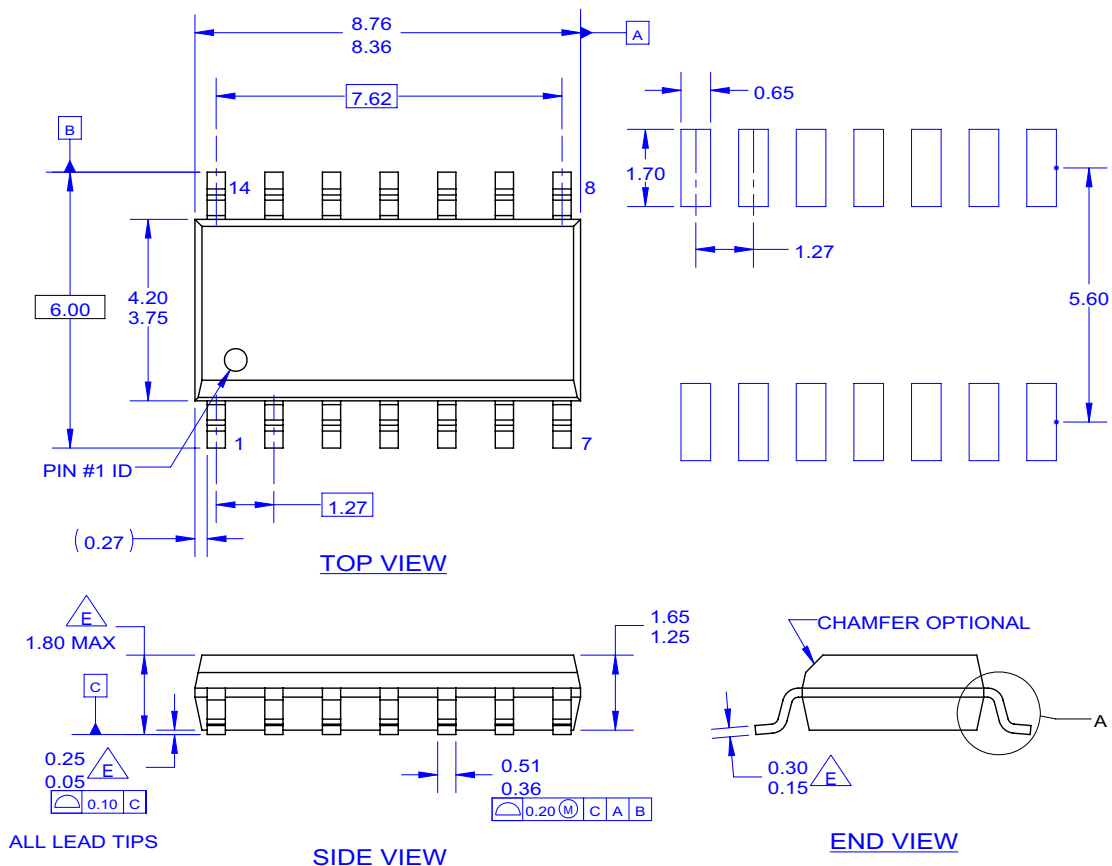

- NOTES: UNLESS OTHERWISE SPECIFIED
- A. THIS PACKAGE REFERENCE TO JEDEC MS-012 VARIATION AB.
  - B. ALL DIMENSIONS ARE IN MILLIMETERS.
  - C. DIMENSIONS ARE EXCLUSIVE OF BURRS, MOLD FLASH AND TIE BAR EXTRUSIONS.
  - D. DIMENSIONS AND TOLERANCES AS PER ASME Y14.5-1994.
  - E. OUT OF JEDEC STANDARD VALUE.
  - F. LAND PATTERN STANDARD: SOIC127P600X145-14M.
  - G. FILE NAME: MKT-M14C REV2

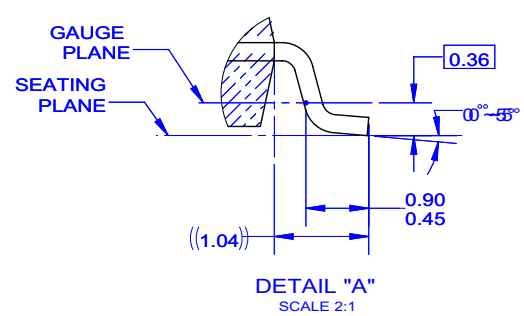

## Ordering Information

Product Number	Package	Operating Temperature
LM324N	14-DIP	0 ~ +70°C
LM324AN		
LM324M	14-SOP	
LM324AM		
LM2902N	14-DIP	-40 ~ +85°C
LM2902M	14-SOP	
LM2902AM		

#### **DISCLAIMER**

FAIRCHILD SEMICONDUCTOR RESERVES THE RIGHT TO MAKE CHANGES WITHOUT FURTHER NOTICE TO ANY PRODUCTS HEREIN TO IMPROVE RELIABILITY, FUNCTION OR DESIGN. FAIRCHILD DOES NOT ASSUME ANY LIABILITY ARISING OUT OF THE APPLICATION OR USE OF ANY PRODUCT OR CIRCUIT DESCRIBED HEREIN; NEITHER DOES IT CONVEY ANY LICENSE UNDER ITS PATENT RIGHTS, NOR THE RIGHTS OF OTHERS.

#### **LIFE SUPPORT POLICY**

FAIRCHILD'S PRODUCTS ARE NOT AUTHORIZED FOR USE AS CRITICAL COMPONENTS IN LIFE SUPPORT DEVICES OR SYSTEMS WITHOUT THE EXPRESS WRITTEN APPROVAL OF THE PRESIDENT OF FAIRCHILD SEMICONDUCTOR CORPORATION. As used herein:

1. Life support devices or systems are devices or systems which, (a) are intended for surgical implant into the body, or (b) support or sustain life, and (c) whose failure to perform when properly used in accordance with instructions for use provided in the labeling, can be reasonably expected to result in a significant injury of the user.
2. A critical component in any component of a life support device or system whose failure to perform can be reasonably expected to cause the failure of the life support device or system, or to affect its safety or effectiveness.

# Mouser Electronics

Authorized Distributor

Click to View Pricing, Inventory, Delivery & Lifecycle Information:

[Fairchild Semiconductor:](#)

[LM324M](#) [LM324N](#) [LM324MX](#)