

## GENERAL DESCRIPTION

CM6800U/CM6802U/CM6862U is a turbo-speed PFC and a Green PWM controller. It is designed to further increase power supply efficiency while using the relatively lower 380V Bulk Capacitor value.

Switching to CM6800U/CM6802U/CM6862U from your existing CM6800 family boards can gain the following advanced performances:

- 1.) Hold Up time can be increased ~ 30% from the existing 6800 power supply
- 2.) Turbo Speed PFC may reduce 420 Bulk Capacitor size
- 3.) 420V bulk capacitor value may be reduced and PFC Boost Capacitor ripple current can be reduced
- 4.) No Load Consumption can be reduced 290mW at 270VAC
- 5.) Better Power Factor and Better THD
- 6.) Clean Digital PFC Brown Out
- 7.) PWM transformer size can be smaller (Feed-Forward Function)
- 8.) Superior Surge Noise Immunity
- 9.) To design 12V, 5V, and 3.3V output filters can be easy
- 10.) The stress over the entire external power device is reduced and EMI noise maybe reduced; PFC inductor core might be reduced
- 11.) Monotonic Output design is easy
- 12.) And more... Of course, the cost can be reduced

CM6800U/CM6802U/CM6862U is pin to pin compatible with CM6800 family.

Beside all the goodies in the CM6800, it is designed to meet the EPA/87+ regulation. With the proper design, its efficiency of power supply can easily approach 85%.

To start evaluating CM6800U/02U/62U from the exiting CM6800, CM6800A, or ML4800 board, 6 things need to be taken care before doing the fine tune:

- 1.) Change  $R_{AC}$  resistor (on pin 2,  $I_{AC}$ ) from the old value to a higher resistor value between 4.7 Mega ohm to 8 Mega ohm. Start with 6 Mega ohm for  $R_{AC}$  first.
- 2.) Change  $R_T C_T$  pin (pin 7) from the existing value to  $R_T=5.88K$  ohm and  $C_T=1000pF$  to have  $f_{PFC}=68KHz$ ,  $f_{PWM}=68KHz$ ,  $f_{R_T C_T}=272KHz$  for CM6800/02/62UA ;  $f_{PFC}=68KHz$ ,  $f_{PWM}=136KHz$ ,  $f_{R_T C_T}=272KHz$  for CM6800/02/62UB
- 3.) Adjust all high voltage resistor around 5 mega ohm or higher.
- 4.) VRMS pin(pin 4) needs to be 1.14V at  $V_{IN}=80V_{AC}$  for universal input application from line input from  $80V_{AC}$  to  $270V_{AC}$ .
- 5.) At full load, the average VEAO needs to around 4.5V and the ripple on the VEAO needs to be less than 250mV when the load triggers the light load comparator.
- 6.) PWM's Ramp2 internal have feed-forward current from VFB Pin. This pin contact to VCC or Vref Pin resistor need reduce value from the exiting CM6800A/02.

## FEATURES

- ◆ Patents Pending
- ◆ Pin to pin compatible with CM6800 family, S family and T family
- ◆ Turbo Speed PFC II
- ◆ Internal  $V_{FB}$  V to I for feed-forward ramp ; Resistor at Ramp2 pin can be removed
- ◆ Smaller Transformer for pre-shorted test
- ◆ Line frequency ripple at output can be reduced
- ◆ Precision 533mS Digital Sagging Timer during PFC Brown Out
- ◆ 23V Bi-CMOS process
- ◆ Designed for EPA/87+ efficiency
- ◆ Digitized Exactly 50% Maximum PWM Duty Cycle
- ◆ Hold-Up Time Goes Up 3mS ~ 5mS Longer
- ◆ All high voltage resistors can be greater than 6 Mega ohm (6 Mega to 8 Mega ohm) to improve the no load consumption
- ◆ Rail to rail CMOS Drivers with on, 60 ohm and off, 30 ohm for both PFC and PWM with two 17V zeners
- ◆ Fast Start-UP Circuit without extra bleed resistor to aid VCC reaches 13V sooner
- ◆ Low start-up current (55uA typ.)
- ◆ Low operating current (2.5mA typ.)
- ◆ 16.5V VCC shunt regulator
- ◆ Leading Edge Blanking for both PFC and PWM
- ◆  $f_{R_T C_T} = 4 * f_{PFC} = 4 * f_{PWM}$  for CM6800/02/62UA
- ◆  $f_{R_T C_T} = 4 * f_{PFC} = 2 * f_{PWM}$  for CM6800/02//62UB
- ◆ Dynamic Soft PFC to ease the stress of the Power Device and Ease the EMI filter design
- ◆ Clean Digital PFC Brown Out and PWM Brown Out
- ◆ Turbo Speed PFC may reduce 420V Bulk Capacitor size
- ◆ Internally synchronized leading edge PFC and trailing edge PWM in one IC to Reduces ripple current in the 420V storage capacitor between the PFC and PWM sections
- ◆ Better Power Factor and Better THD
- ◆ Average current, continuous or discontinuous boost leading edge PFC
- ◆ PWM configurable for current mode or feed-forward voltage mode operation
- ◆ Current fed Gain Modulator for improved noise immunity
- ◆ Gain Modulator is a constant maximum power limiter
- ◆ Precision Current Limit, over-voltage protection, UVLO, soft start, and Reference OK

## APPLICATIONS

- ◆ EPA/87+ related Power Supply
- ◆ Desktop PC Power Supply
- ◆ Internet Server Power Supply
- ◆ LCD Power Supply
- ◆ PDP Power Supply
- ◆ IPC Power Supply
- ◆ UPS
- ◆ Battery Charger
- ◆ DC Motor Power Supply
- ◆ Monitor Power Supply
- ◆ Telecom System Power Supply
- ◆ Distributed Power

## PIN CONFIGURATION

SOP-16 (S16) / DIP-16 (P16)

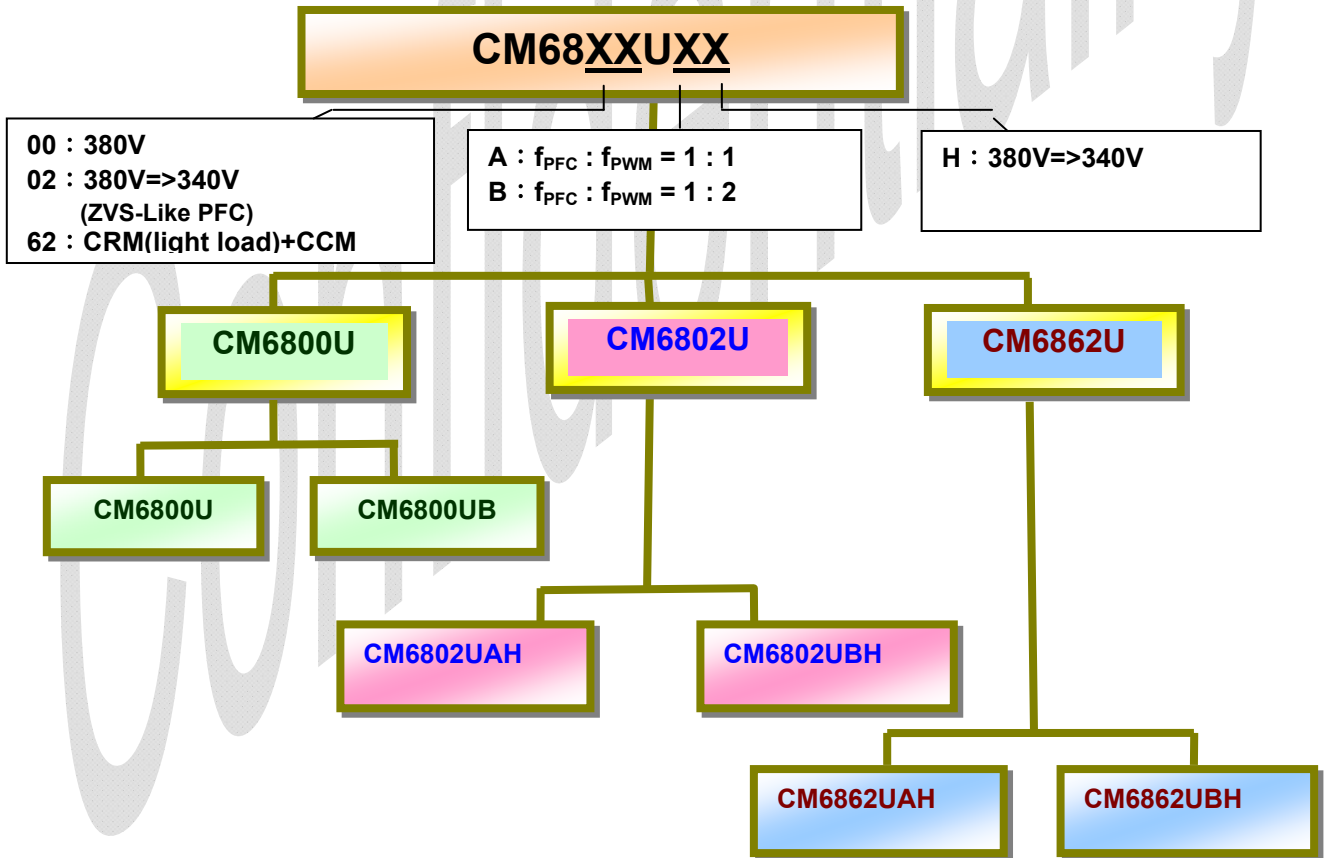
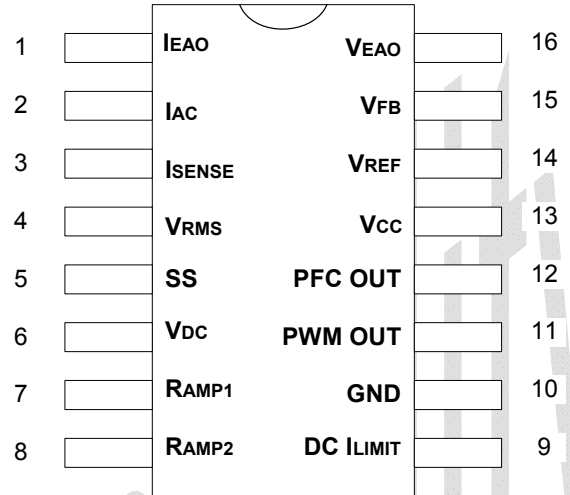

## PIN DESCRIPTION

| Pin No. | Symbol                                  | Description  | Operating Voltage |      |      |      |
|---------|---|--|-------------------|------|------|------|
|         |   |  | Min.              | Typ. | Max. | Unit |
| 1       | I <sub>EAO</sub>                        | PFC trans-conductance current error amplifier output (GMi).  | 0                 |      | 7.5  | V    |
| 2       | I <sub>AC</sub>                         | IAC has 2 functions:<br>1. PFC gain modulator reference input.<br>2. Typical RAC resistor is about 4~6 Mega ohm to sense the line.   | 0                 |      | 100  | uA   |
| 3       | I <sub>SENSE</sub>                      | PFC Current Sense: for both Gain Modulator and PFC current I <sub>LIMIT</sub> comparator.  | -1.3              |      | 0.7  | V    |
| 4       | V <sub>RMS</sub>                        | Line Input Sense pin and also, it is the brown in/out sense pin.   | 0                 |      | 8    | V    |
| 5       | SS                                      | Soft start capacitor pin; it is pulled down by 70K ohm internal resistor when DC <sub>LIMIT</sub> reach 1V; the power is limited during the PWM stage.   | 0                 |      | VCC  | V    |
| 6       | V <sub>DC</sub>                         | DC to DC PWM stage voltage feedback input.   | 0                 |      | 10   | V    |
| 7       | RAMP1 (R <sub>T</sub> -C <sub>T</sub> ) | Oscillator timing node; PFC frequency set by R <sub>T</sub> and C <sub>T</sub>   | 0.8               |      | 4    | V    |
| 8       | RAMP 2 (PWM RAMP)                       | In current mode, this pin functions as the current sense input; when in voltage mode, Internal V <sub>FB</sub> V to I for feed-forward ramp, and it represents PFC output 380V. It only requires a capacitor to ground. The external resistor can be eliminated. | 0                 |      | VCC  | V    |
| 9       | DC I <sub>LIMIT</sub>                   | PWM current limit comparator input   | 0                 |      | 1    | V    |
| 10      | GND                                     | Ground   |                   |      |      |      |
| 11      | PWM OUT                                 | PWM driver output  | 0                 |      | VCC  | V    |
| 12      | PFC OUT                                 | PFC driver output  | 0                 |      | VCC  | V    |
| 13      | V <sub>CC</sub>                         | Positive supply for CM6800U/02U/62U  | 10                | 15   | 20   | V    |
| 14      | V <sub>REF</sub>                        | Maximum 3.5mA buffered output for the internal 7.5V reference when VCC=14V   |                   | 7.5  |      | V    |
| 15      | V <sub>FB</sub>                         | PFC trans-conductance voltage error amplifier input  | 0                 | 2.5  | 3    | V    |
| 16      | VEAO                                    | PFC trans-conductance voltage error amplifier output (GMv)   | 0                 |      | 6    | V    |

## ORDERING INFORMATION

| Part Number | Package  | Temperature Range |
|-------------|--|-------------------|
| CM6800U     | XIP*<br>XIS*<br>XISTR*<br><br>16-Pin DIP (P16)<br>16-Pin Narrow SOP (S16)<br>16-Pin Narrow SOP (S16) | -40°C to 125°C    |
| CM6800UB    |  |                   |
| CM6802UAH   |  |                   |
| CM6802UBH   |  |                   |
| CM6862UAH   |  |                   |
| CM6862UBH   |  |                   |

**\*Note:** X : Suffix for Halogen Free and PB Free Product  
 TR : Package is Tape & Reel

## SIMPLIFIED BLOCK DIAGRAM

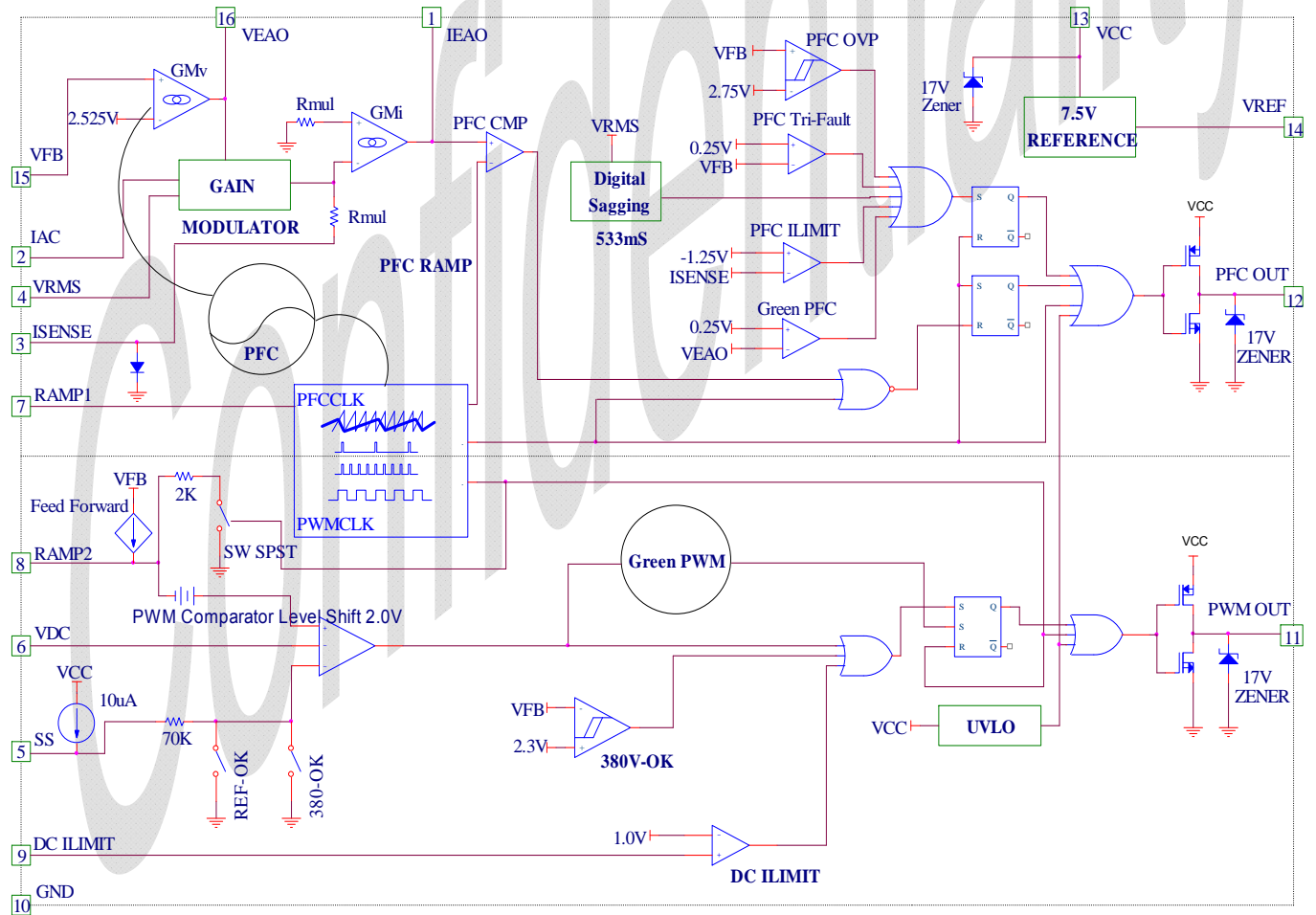



## ABSOLUTE MAXIMUM RATINGS

Absolute Maximum ratings are those values beyond which the device could be permanently damaged.

| Parameter   | Min.      | Max.                  | Units |
|---|-----------|-----------------------|-------|
| V <sub>CC</sub>   |           | 21                    | V     |
| V <sub>REF</sub>  | GND – 0.3 | 8                     | V     |
| V <sub>REF</sub> (transient/load regulation) overshoot (period less than 1ms)   |           | 8.5                   | V     |
| V <sub>REF</sub> (transient/load regulation) overshoot (period less than 300us) |           | 10                    | V     |
| IEAO  | GND – 0.3 | V <sub>REF</sub> +0.3 | V     |
| I <sub>SENSE</sub> Voltage  | -5        | 0.7                   | V     |
| I <sub>SENSE</sub> Voltage (period less than 1ms)                               | -10       | 0.7                   | V     |
| PFC OUT   | GND – 0.3 | V <sub>CC</sub> + 0.3 | V     |
| PWM OUT   | GND – 0.3 | V <sub>CC</sub> + 0.3 | V     |
| PFC/PWM Out Driver (period less than 50nS)                                      | GND – 3.0 | V <sub>CC</sub> + 0.3 | V     |
| PFC/PWM Out Driver (period less than 25nS)                                      | GND – 5.0 | V <sub>CC</sub> + 0.3 | V     |
| Voltage on Any Other Pin  | GND – 0.3 | V <sub>CC</sub> + 0.3 | V     |
| I <sub>REF</sub>  |           | 3.5                   | mA    |
| I <sub>AC</sub> Input Current   |           | 1                     | mA    |
| Peak PFC OUT Current, Source or Sink  |           | 0.5                   | A     |
| Peak PWM OUT Current, Source or Sink  |           | 0.5                   | A     |
| Peak PFC/PWM OUT Current, Source or Sink (period less than 5us)                 |           | 1                     | A     |
| PFC OUT, PWM OUT Energy Per Cycle   |           | 1.5                   | μJ    |
| Junction Temperature  |           | 150                   | °C    |
| Storage Temperature Range   | -65       | 150                   | °C    |
| Operating Temperature Range   | -40       | 125                   | °C    |
| Lead Temperature (Soldering, 10 sec)  |           | 260                   | °C    |
| Thermal Resistance (θ <sub>JA</sub> )   |           |                       |       |
| Plastic DIP   |           | 80                    | °C/W  |
| Plastic SOIC  |           | 105                   | °C/W  |
| Power Dissipation (PD) T <sub>A</sub> <50°C                                     |           | 800                   | mW    |
| ESD Capability, HBM Model   |           | 5.5                   | KV    |
| ESD Capability, CDM Model   |           | 1250                  | V     |

## ELECTRICAL CHARACTERISTICS

Unless otherwise stated, these specifications apply test conditions  $V_{CC}=+14V$ ,  $R_T = 5.88\text{ k}\Omega$ ,  $C_T = 1000\text{pF}$ ,  $T_A=\text{Operating Temperature Range (Note 1)}$

| Symbol                                     | Parameter                         | Test Conditions  | CM6800U/02U/62U |       |      | Unit            |
|--|-----------------------------------|--|-----------------|-------|------|-----------------|
|  |                                   |  | Min.            | Typ.  | Max. |                 |
| <b>Clean Digital PFC Brown in / Out</b>    |                                   |  |                 |       |      |                 |
| VRMS (H)                                   | VRMS Threshold High(brown in)     | Room Temperature=25°C  | 1.70            | 1.78  | 1.84 | V               |
| VRMS (L)                                   | VRMS Threshold Low (brown out)    | Room Temperature=25°C  | 0.98            | 1.03  | 1.08 | V               |
| VRMS(H)-<br>VRMS (L)                       | Hysteresis                        |  | 720             |       | 760  | mV              |
| <b>AC High/ Low Line</b>                   |                                   |  |                 |       |      |                 |
| VRMS                                       | AC High Line                      | Sweep VRMS Pin for CM6802U/62U only  | 2.9             | 3     | 3.1  | V               |
| VRMS                                       | AC Low Line                       | Sweep VRMS Pin for CM6802U/62U only  | 1.9             | 2     | 2.1  | V               |
| VRMS                                       | Hysteresis                        | for CM6802U/62U only   | 0.9             | 1     | 1.1  | V               |
| <b>VEAO: Voltage Error Amplifier (GMv)</b> |                                   |  |                 |       |      |                 |
|  | Input Voltage Range               |  | 0               |       | 3    | V               |
| GMv  | Trans-conductance                 | $V_{NONINV} = V_{INV}$ , VEAO = 3.35V @ T=25°C   | 25              | 40    | 60   | $\mu\text{mho}$ |
| VFB  | Feedback Reference Voltage (High) | Bulk voltage feedback reference voltage For CM6800U/UB                                       | 2.5             | 2.525 | 2.55 | V               |
| VFB  | Feedback Reference Voltage (Low)  | Bulk voltage feedback reference voltage For CM6802U/62U only                                 | 2.24            |       | 2.32 | V               |
| <b>Light load / Full load Detect</b>       |                                   |  |                 |       |      |                 |
| Veao                                       | Full Load Threshold Veao (High)   | Vrms=low line and Veao=Veao(High) than VFB switch to VFB reference high for CM6802U/62U only | 2.4             | 2.5   | 2.6  | V               |
| Veao                                       | Light Load Threshold Veao (Low)   | Vrms=low line and Veao=Veao( Low) than VFB switch to VFB reference low for CM6802U/62U only  | 1.9             | 2     | 2.1  | V               |
|  | Hysteresis                        | for CM6802U/62U only   | 0.4             | 0.5   | 0.6  | V               |
| I(VEAO)                                    | Input Bias Current                | Note 2   | -1.0            | -0.05 |      | $\mu\text{A}$   |
| VEAO (max)                                 | Output High Voltage               |  | 5.8             | 6.0   |      | V               |
| VEAO (min)                                 | Output Low Voltage                |  |                 | 0.1   | 0.4  | V               |
| Isink                                      | Sink Current                      | Overdrive Voltage = 100mV @ T=25°C   | -60             | -50   | -40  | $\mu\text{A}$   |
| Isource                                    | Source Current                    | Overdrive Voltage = 100mV @ T=25°C   | 1               | 3     | 5    | $\mu\text{A}$   |
| Gv   | Open Loop Gain                    | Guaranteed by design   | 30              | 40    |      | dB              |
| PSRR                                       | Power Supply Rejection Ratio      | 11V < $V_{CC}$ < 16.5V   | 60              | 75    |      | dB              |

## ELECTRICAL CHARACTERISTICS

(Conti.) Unless otherwise stated, these specifications apply test conditions  $V_{CC}=+14V$ ,  $R_T = 5.88\text{ k}\Omega$ ,  $C_T = 1000\text{pF}$ ,  $T_A$ =Operating Temperature Range (Note 1)

| Symbol                                     | Parameter                                      | Test Conditions  | CM6800U/02U/62U |       |       | Unit             |
|--|--|--|-----------------|-------|-------|------------------|
|  |  |  | Min.            | Typ.  | Max.  |                  |
| <b>IEAO: Current Error Amplifier (GMi)</b> |  |  |                 |       |       |                  |
| GMi  | Trans-conductance                              | $V_{NONINV} = V_{INV}$ , IEAO = 1.5V @ T=25°C                                    | 50              | 70    | 90    | $\mu\text{ mho}$ |
| VOFFSET                                    | Input Offset Voltage                           | VEAO=0V, IAC is open   | -25             |       | 25    | mV               |
| IEAO (max)                                 | Output High Voltage                            |  | 7.4             | 7.5   | 7.6   | V                |
| IEAO (min)                                 | Output Low Voltage                             |  |                 | 0.1   | 0.4   | V                |
| Isink                                      | Sink Current                                   | $I_{SENSE} = -0.5V$ , IEAO = 1.5V @ T=25°C                                       | -45             | -35   | -25   | $\mu\text{ A}$   |
| Isorce                                     | Source Current                                 | $I_{SENSE} = +0.5V$ , IEAO = 4.0V @ T=25°C                                       | 25              | 35    | 45    | $\mu\text{ A}$   |
| Gv   | Open Loop Gain                                 | DC Gain  | 30              | 40    |       | dB               |
| PSRR                                       | Power Supply Rejection Ratio                   | $11V < V_{CC} < 16.5V$   | 60              | 75    |       | dB               |
| <b>PFC OVP Comparator</b>                  |  |  |                 |       |       |                  |
| Vovp                                       | Threshold Voltage                              |  | 2.65            | 2.75  | 2.85  | V                |
| HY(ovp)                                    | Hysteresis                                     |  | 150             |       | 200   | mV               |
| <b>PFC Green Power Detect Comparator</b>   |  |  |                 |       |       |                  |
| Vth  | VEAO Threshold Voltage                         |  | 0.1             | 0.25  | 0.4   | V                |
| <b>Tri-Fault Detect</b>                    |  |  |                 |       |       |                  |
| F(H)                                       | Fault Detect HIGH                              | VFB detect bulk voltage O.V.P  | 2.65            | 2.75  | 2.85  | V                |
| Td(F)                                      | Time to Fault Detect HIGH                      | $V_{FB}=V_{FAULT\ DETECT\ LOW}$ to<br>$V_{FB}=OPEN$ , 470pF from $V_{FB}$ to GND |                 | 2     | 4     | ms               |
| F(L)                                       | Fault Detect Low                               |  | 0.1             | 0.25  | 0.4   | V                |
| <b>PFC I<sub>LIMIT</sub> Comparator</b>    |  |  |                 |       |       |                  |
| Vth  | Threshold Voltage                              | Compare Isense voltage input   | -1.35           | -1.25 | -1.15 | V                |
| Vth-Vgm                                    | (PFC <sub>LIMIT</sub> - Gain Modulator Output) |  | 350             | 450   |       | mV               |
| Td(PFC_OFF)                                | Delay to Output (Note 4)                       | Overdrive Voltage = -100mV   |                 | 700   |       | ns               |

## ELECTRICAL CHARACTERISTICS

(Conti.) Unless otherwise stated, these specifications apply test conditions  $V_{CC}=+14V$ ,  $R_T = 5.88\text{ k}\Omega$ ,  $C_T = 1000\text{pF}$ ,  $T_A$ =Operating Temperature Range (Note 1)

| Symbol  | Parameter   | Test Conditions  | CM6800U/02U/62U |      |      | Unit |
|---|---|--|-----------------|------|------|------|
|   |   |  | Min.            | Typ. | Max. |      |
| <b>DC I<sub>LIMIT</sub> Comparator</b>  |   |  |                 |      |      |      |
| V <sub>th</sub> (DC)  | Threshold Voltage                                     | PWM current limit  | 0.92            | 1.0  | 1.08 | V    |
| T <sub>d</sub> (P <sub>WM_OFF</sub> )   | Delay to Output (Note 4)                              | Overdrive Voltage = 100mV  |                 | 700  |      | ns   |
| <b>DC to DC PWM Brown in / Out Comparator</b>                                     |   |  |                 |      |      |      |
| V <sub>th</sub> (OK)  | OK Threshold Voltage                                  | PWM turn on (High)   | 2.2             | 2.3  | 2.4  | V    |
| V <sub>th</sub> (OK)  | OK Threshold Voltage                                  | PWM turn off (Low) <b>for CM68xxU</b>  | 1.2             |      | 1.5  | V    |
| HY(OK)  | Hysteresis  | <b>for CM68xxU</b>   | 0.9             | 0.95 | 1    | V    |
| <b>GAIN Modulator</b>   |   |  |                 |      |      |      |
| G1  | Gain1 (Note 3)  | $I_{AC} = 20\ \mu\text{A}$ , $V_{RMS} = 1.125$ , $V_{FB} = 2.375\text{V}$ @ $T=25^\circ\text{C}$           | 5.5             | 6    | 6.5  |      |
| G2  | Gain2 (Note 3)  | $I_{AC} = 20\ \mu\text{A}$ , $V_{RMS} = 1.45588\text{V}$ , $V_{FB} = 2.375\text{V}$ @ $T=25^\circ\text{C}$ | 5               | 5.5  | 6    |      |
| G3  | Gain3 (Note 3)  | $I_{AC} = 20\ \mu\text{A}$ , $V_{RMS} = 2.91\text{V}$ , $V_{FB} = 2.375\text{V}$ @ $T=25^\circ\text{C}$    | 1.2             | 1.5  | 1.8  |      |
| G4  | Gain4 (Note 3)  | $I_{AC} = 20\ \mu\text{A}$ , $V_{RMS} = 3.44\text{V}$ , $V_{FB} = 2.375\text{V}$ @ $T=25^\circ\text{C}$    | 0.9             | 1.1  | 1.3  |      |
| BW  | Bandwidth (Note 4)                                    | $I_{AC} = 40\ \mu\text{A}$   |                 | 1    |      | MHz  |
| V <sub>o</sub> (gm)   | Output Voltage = $R_{mul} * (I_{SENSE} - I_{OFFSET})$ | $I_{AC} = 50\ \mu\text{A}$ , $V_{RMS} = 1.125\text{V}$ , $V_{FB} = 2\text{V}$                              | 0.78            | 0.83 | 0.88 | V    |
| <b>Oscillator (Measuring fpfc) set up PFC and PWM oscillator frequency(ramp1)</b> |   |  |                 |      |      |      |
| Fosc1   | Initial fpfc Accuracy (Note 1)                        | $R_T = 5.88\text{ k}\Omega$ , $C_T = 1000\text{pF}$ , $T_A = 25^\circ\text{C}$<br>$I_{AC}=0\mu\text{A}$    | 63              | 68   | 73   | kHz  |
| $\Delta$ Fosc1  | Voltage Stability                                     | $11\text{V} < V_{CC} < 16.5\text{V}$   |                 | 2    |      | %    |
| $\Delta$ Fosc2  | Temperature Stability                                 |  |                 | 2    |      | %    |
| Fosc2   | Total Variation                                       | Line, Temp   | 60              |      | 75   | kHz  |
| V <sub>RAMP</sub>   | Ramp Valley to Peak Voltage                           | $V_{EAO}=6\text{V}$ and $I_{AC}=20\mu\text{A}$   |                 | 2.5  |      | V    |
| T <sub>dead</sub>   | PFC Dead Time (Note 4)                                |  | 500             |      | 700  | ns   |
| I <sub>dis</sub>  | CT Discharge Current                                  | $V_{RAMP2} = 0\text{V}$ , $V_{RAMP1} = 2.5\text{V}$  | 9               | 10   | 11   | mA   |



**ELECTRICAL CHARACTERISTICS (Conti.)** Unless otherwise stated, these specifications apply test conditions  $V_{CC}=+14V$ ,  $R_T = 5.88\text{ k}\Omega$ ,  $C_T = 1000\text{pF}$ ,  $T_A=\text{Operating Temperature Range (Note 1)}$ 

| Symbol                             | Parameter                           | Test Conditions  | CM6800U/02U/62U |      |       | Unit          |
|------------------------------------|-------------------------------------|--|-----------------|------|-------|---------------|
|                                    |                                     |  | Min.            | Typ. | Max.  |               |
| <b>Reference(VREF)</b>             |                                     |  |                 |      |       |               |
|                                    | Output Voltage                      | $T_A = -45^\circ\text{C} \sim 85^\circ\text{C}$ , $I(VREF) = 0 \sim 3.5\text{mA}$                | 7.47            | 7.5  | 7.53  | V             |
|                                    | Line Regulation                     | $11V < V_{CC} < 16.5V @ T=25^\circ\text{C}$  |                 | 3    | 5     | mV            |
|                                    | Load Regulation                     | $V_{CC}=10.5V, 0\text{mA} < I(VREF) < 2\text{mA}; @ T=25^\circ\text{C}$                          |                 | 25   | 50    | mV            |
|                                    |                                     | $V_{CC}=14V, 0\text{mA} < I(VREF) < 3.5\text{mA}; T_A = -45^\circ\text{C} \sim 85^\circ\text{C}$ |                 | 25   | 50    | mV            |
|                                    | Temperature Stability               |  |                 | 0.4  |       | %             |
|                                    | Total Variation                     | Line, Load, Temp   | 7.4             |      | 7.6   | V             |
|                                    | Long Term Stability                 | $T_J = 125^\circ\text{C}$ , 1000HRs  | 5               |      | 25    | mV            |
| <b>PFC</b>                         |                                     |  |                 |      |       |               |
|                                    | Minimum Duty Cycle                  | $V_{IEAO} > 4.5V$  |                 |      | 0     | %             |
|                                    | Maximum Duty Cycle                  | $V_{IEAO} < 1.2V$  | 93              | 95   |       | %             |
|                                    | Output Low Rdson                    | $I_{OUT} = -20\text{mA} @ T=25^\circ\text{C}$  |                 | 13   | 18    | ohm           |
|                                    |                                     | $I_{OUT} = -100\text{mA} @ T=25^\circ\text{C}$   |                 |      | 18    | ohm           |
|                                    |                                     | $I_{OUT} = 10\text{mA}, V_{CC} = 9V @ T=25^\circ\text{C}$  |                 | 0.5  | 1     | V             |
|                                    | Output High Rdson                   | $I_{OUT} = 20\text{mA} @ T=25^\circ\text{C}$   |                 | 24   | 30    | ohm           |
|                                    |                                     | $I_{OUT} = 100\text{mA} @ T=25^\circ\text{C}$  |                 |      | 40    | ohm           |
|                                    | Rise/Fall Time (Note 4)             | $C_L = 100\text{pF} @ T=25^\circ\text{C}$  |                 | 50   |       | ns            |
| <b>PWM</b>                         |                                     |  |                 |      |       |               |
|                                    | Duty Cycle Range                    | Ramp2 peak $< (V_{DC} \text{ max voltage} + \text{PWM Comparator Level shift max})$              | 0-49.5          |      | 0-50  | %             |
|                                    | Output Low Rdson                    | $I_{OUT} = -20\text{mA} @ T=25^\circ\text{C}$  |                 | 13   | 18    | ohm           |
|                                    |                                     | $I_{OUT} = -100\text{mA} @ T=25^\circ\text{C}$   |                 |      | 18    | ohm           |
|                                    |                                     | $I_{OUT} = 10\text{mA}, V_{CC} = 9V$   |                 | 0.5  | 1     | V             |
|                                    | Output High Rdson                   | $I_{OUT} = 20\text{mA} @ T=25^\circ\text{C}$   |                 | 25   | 40    | ohm           |
|                                    |                                     | $I_{OUT} = 100\text{mA} @ T=25^\circ\text{C}$  |                 |      | 40    | ohm           |
|                                    | Rise/Fall Time (Note 4)             | $C_L = 100\text{pF}$   |                 | 50   |       | ns            |
|                                    | PWM Comparator Level Shift          | @ $T=25^\circ\text{C}$   | 1.8             |      | 2.0   | V             |
|                                    | PWM Comparator Level Shift          | @ $T=125^\circ\text{C}$  | 1.75            |      |       | V             |
|                                    | feed forward current (CM68XXU/A)    | @ $T=25^\circ\text{C}$ VFB=2.5V switching frequency=67.5Khz                                      | 280             |      | 320   | uA            |
|                                    | feed forward current (CM68XXUB)     | @ $T=25^\circ\text{C}$ VFB=2.5V switching frequency=135Khz                                       | 250             |      | 320   | uA            |
|                                    | feed forward current (CM68XXU/A/UB) | @ $T=125^\circ\text{C}$ VFB=2.5V switching frequency=67.5Khz / 135Khz                            |                 |      | 380   | uA            |
| <b>Soft Start</b>                  |                                     |  |                 |      |       |               |
|                                    | Soft Start Current                  | Room Temperature= $25^\circ\text{C}$   | 7               | 10   | 12    | $\mu\text{A}$ |
|                                    | Soft Start Discharge Current        | Soft Start=8V(Test)  | 1               | 3    | 5     | $\mu\text{A}$ |
| <b>Supply</b>                      |                                     |  |                 |      |       |               |
|                                    | Start-Up Current                    | $V_{CC} = 12V, C_L = 0 @ T=25^\circ\text{C}$   |                 | 50   | 65    | $\mu\text{A}$ |
|                                    | Operating Current                   | $14V, C_L = 0$   |                 | 2.5  | 3.5   | mA            |
| Turn-on                            | Under voltage Lockout Threshold     | CM6800U/02U/62U  | 12.5            | 13   | 13.5  | V             |
| Turn-off                           | Under voltage Lockout Threshold     | CM6800U/02U/62U  | 9.5             | 10   | 10.5  | V             |
| Turn-off                           | Under voltage Lockout Hysteresis    | CM6800U/02U/62U  | 2.85            | 3    | 3.15  | V             |
| <b>Shunt Regulator (VCC zener)</b> |                                     |  |                 |      |       |               |
|                                    | Zener Threshold Voltage             | Apply VCC with $I_{op}=20\text{mA}$  | 16.15           | 17   | 17.85 | V             |

Note 1: Limits are guaranteed by 100% testing, sampling, or correlation with worst-case test conditions.

Note 2: Includes all bias currents to other circuits connected to the  $V_{FB}$  pin.

Note 3: Gain  $\sim K \times 5.3V$ ;  $K = (I_{SENSE} - I_{OFFSET}) \times [I_{AC} (VEAO - 0.7)]^{-1}$ ;  $VEAO_{MAX} = 6V$

Note 4: Guaranteed by design, not 100% production test.

**TEST CONDITIONS :**

- 1. AC-ON Voltage : 90Vac/60Hz/166ms
- 2. AC-OFF Voltage : 0Vac/60Hz/2ms · 4ms, 8ms, 16ms, 20ms, 40ms
- 3. Test temperature : 25°C
- 4. Load capacitance : No
- 5. Load : Max load ( 12Vmain/14A, 12Vcpu/4.5A, -12V/0.15A, 12Vsb/1.3A )

**TEST EQUIPMENTS :**

- 1. Tektronix/TDS3054B
- 2. Tektronix/TCPA300 ( Range : 1A/V, Coupling : DC )

**Test results of cycle drop out as PFC current are shown in below :**

(CH1: AC Input CH2: PFC Current)

CM6800U/02U/62U @ 2ms Cycle Drop Out

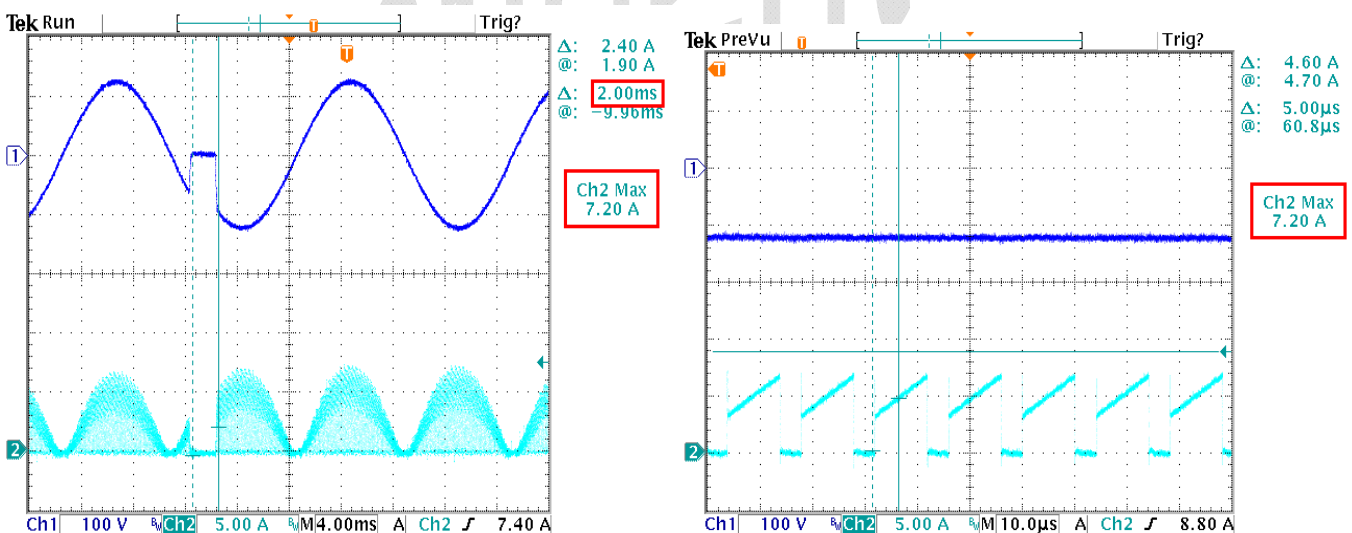

CM6800U/02U/62U @ 4ms Cycle Drop Out

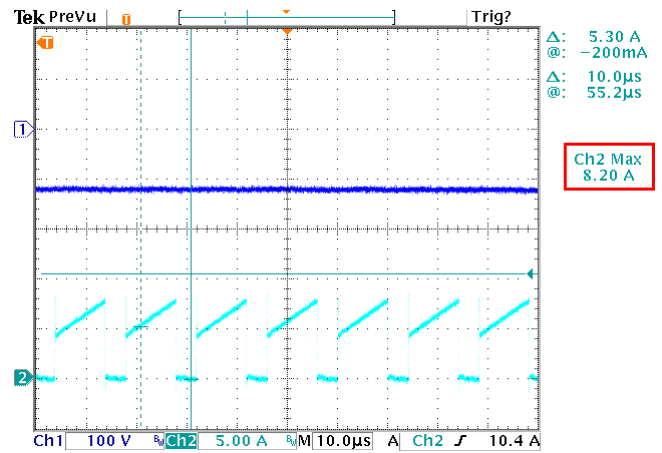
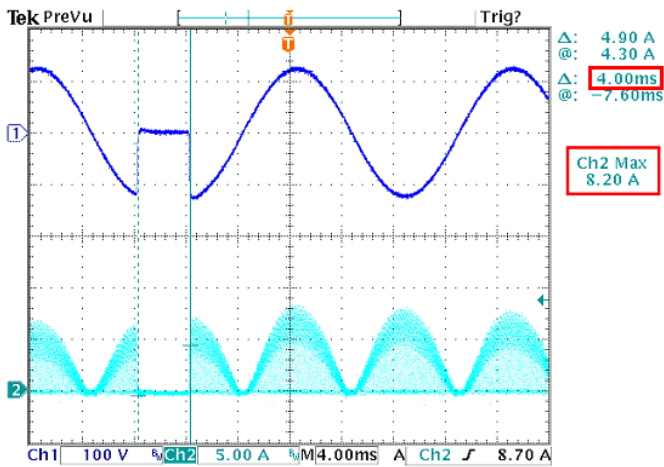

CM6800U/02U/62U @ 8ms Cycle Drop Out

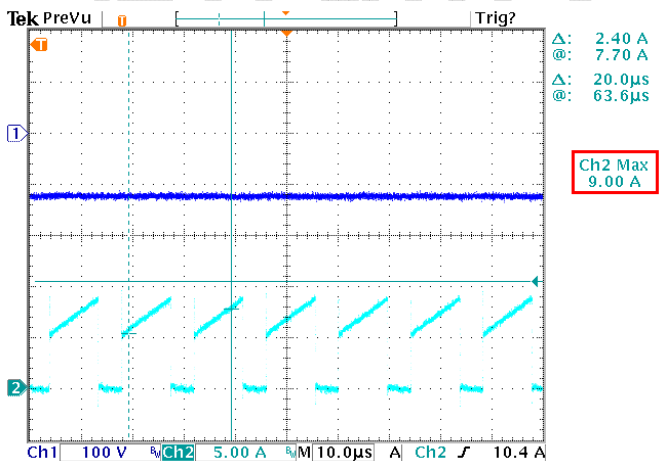
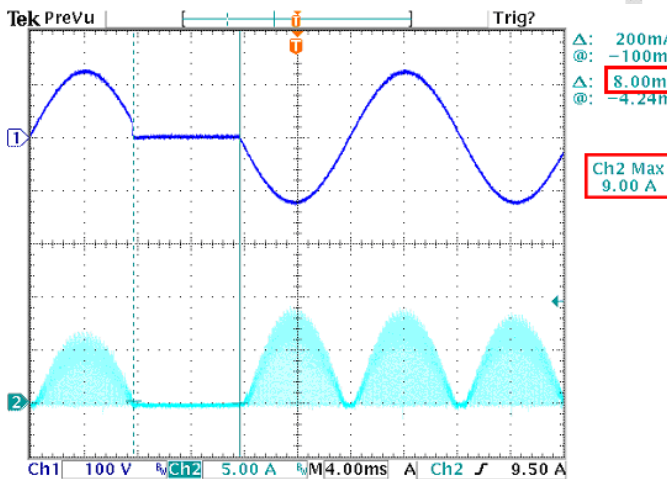

CM6800U/02U/62U @ 16ms Cycle Drop Out

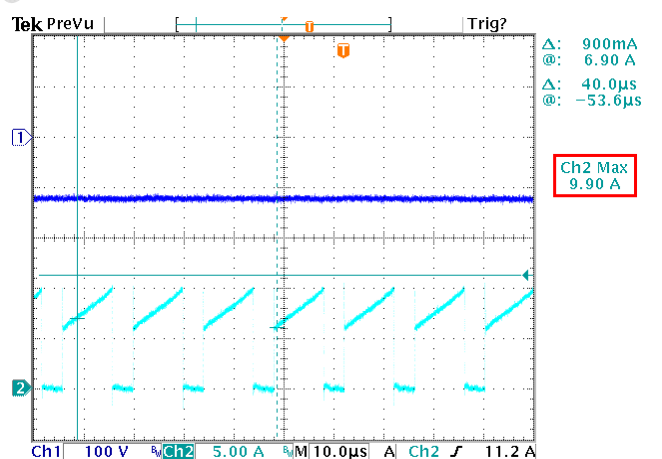
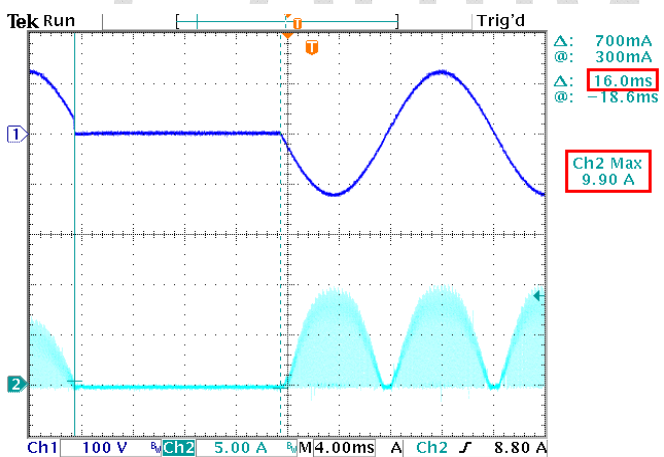

CM6800U/02U/62U @ 20ms Cycle Drop Out

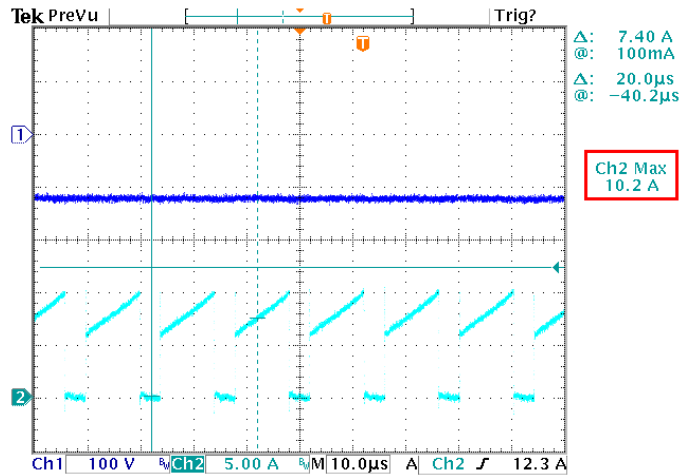
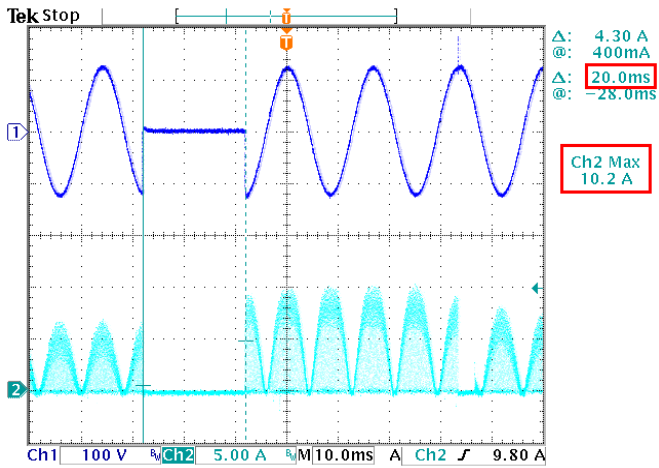

CM6800U/02U/62U @ 40ms Cycle Drop Out

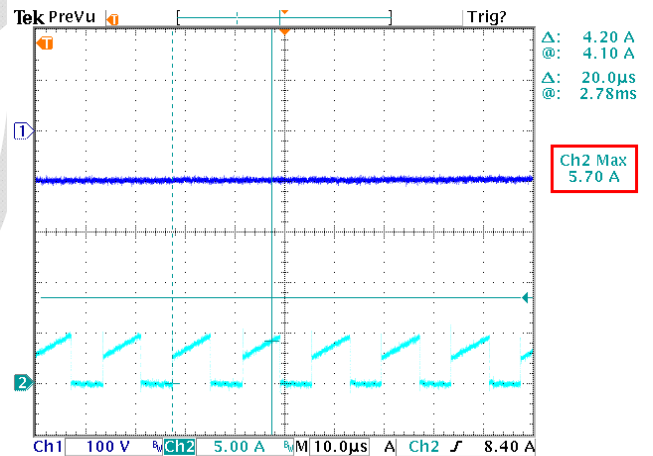
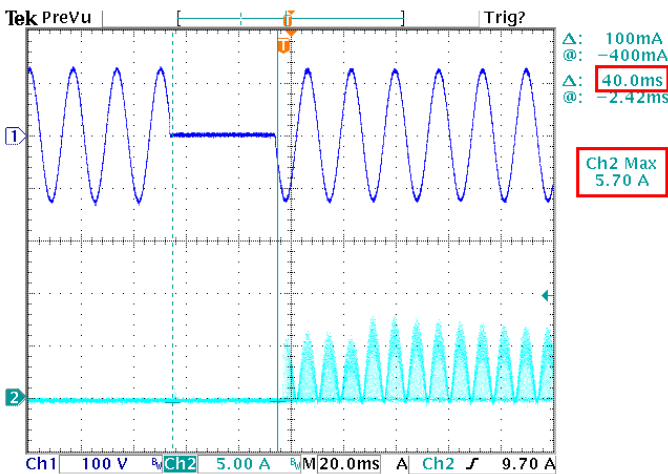

## TYPICAL PERFORMANCE CHARACTERISTIC

### PFC Soft Diagram :

Dynamic Soft PFC Performance @ Vin=110 Vac

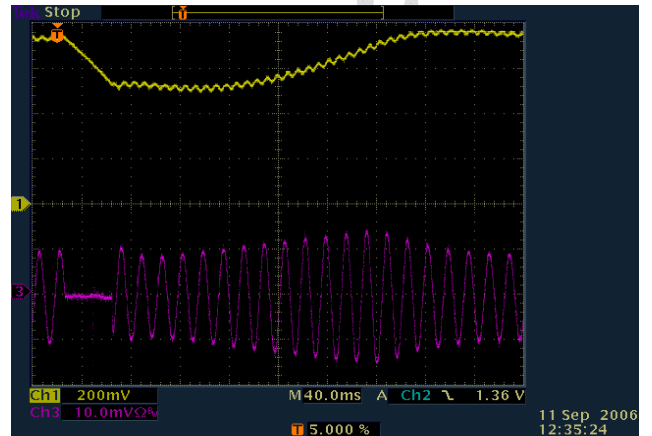
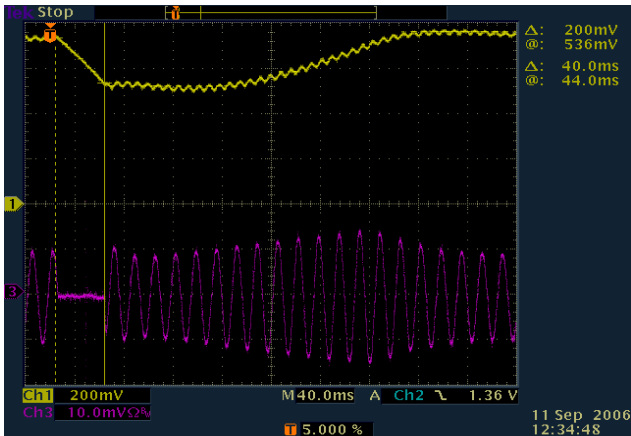

Ch1 is 380V bulk cap voltage which is 100V/div.  
Ch3 is Input Line Current which is 1A/div.

Input Line Voltage (110 Vac) was turned off for 40mS before reaching PWM Brownout which is 209Vdc. When the bulk cap voltage goes below 209V, the system will reset the PWM soft start. The result of the CM6800U/02U/62U Input Line Current has a clean Off and softly On even the system does not reset PWM soft-start.

Dynamic Soft PFC Performance @ Vin=220 Vac

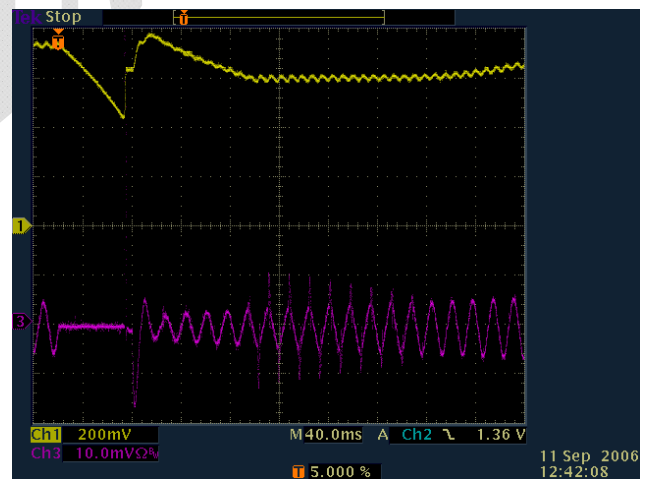
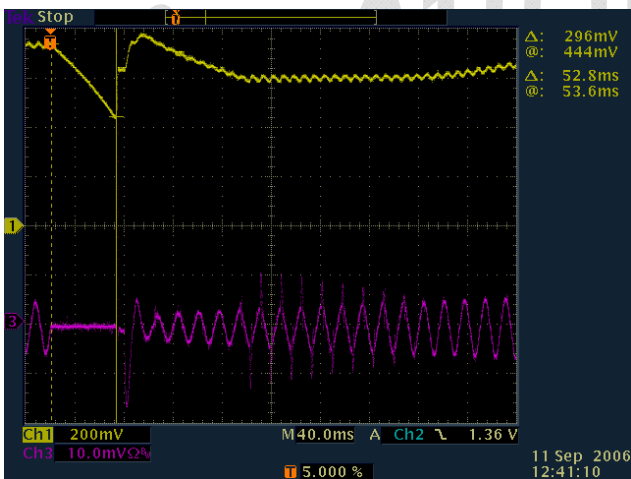

Ch1 is 380V bulk cap voltage which is 100V/div.  
Ch3 is Input Line Current which is 1A/div.

Input Line Voltage (220 V<sub>AC</sub>) was turned off for 40mS before reaching PWM Brownout which is 209Vdc when Bulk cap voltage drops below 209V. When the bulk cap voltage goes below 209V, the system will reset the PWM soft start. The result of the CM6800U/02U/62U Input Line Current has a clean Off and softly On even the system does not reset itself. The first peak current at the beginning of the On time is the inrush current.

Turn on Timing :

Output 50% and 100% load turn on waveform at 110Vac

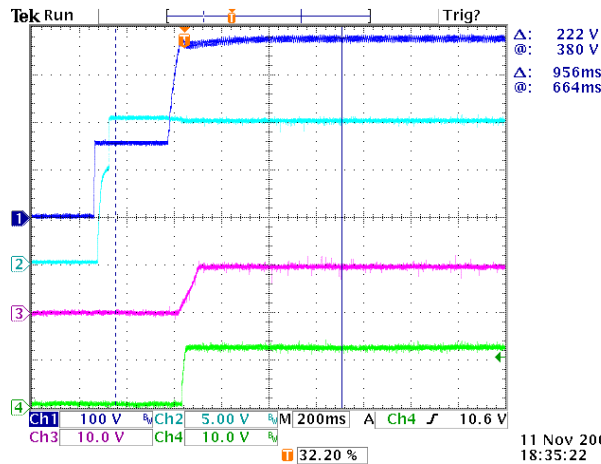

Ch1 is 380V bulk cap voltage which is 100V/div.  
Ch2 is VCC, Ch3 is SS(soft start pin), CH4 is Vo(12V).

Output 10% and 20% load turn on waveform at 230Vac

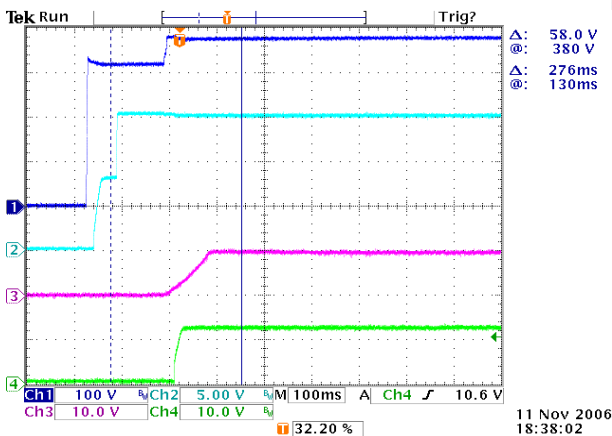

Ch1 is 380V bulk cap voltage which is 100V/div.  
Ch2 is VCC, Ch3 is SS(soft start pin), CH4 is Vo(12V)

Output 50% and 100% load turn on waveform at 230Vac

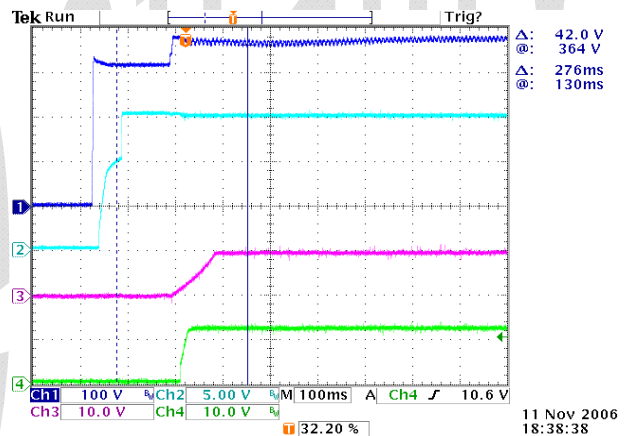

Ch1 is 380V bulk cap voltage which is 100V/div.  
Ch2 is VCC, Ch3 is SS(soft start pin), CH4 is Vo(12V)

Dynamic load:

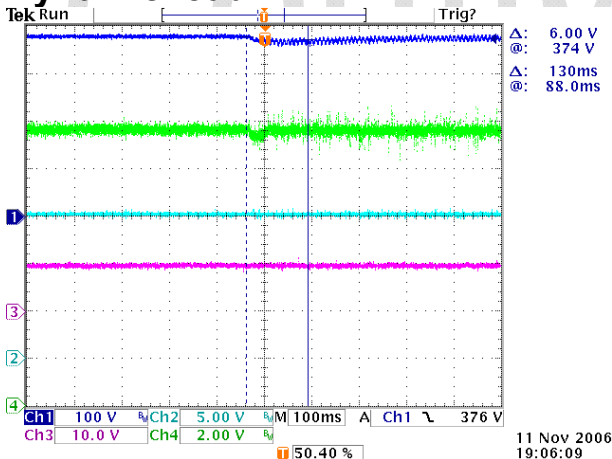

Ch1 is 380V bulk cap voltage which is 100V/div.  
Ch2 is VCC, Ch3 is SS(soft start pin), CH4 is Vo(12V)

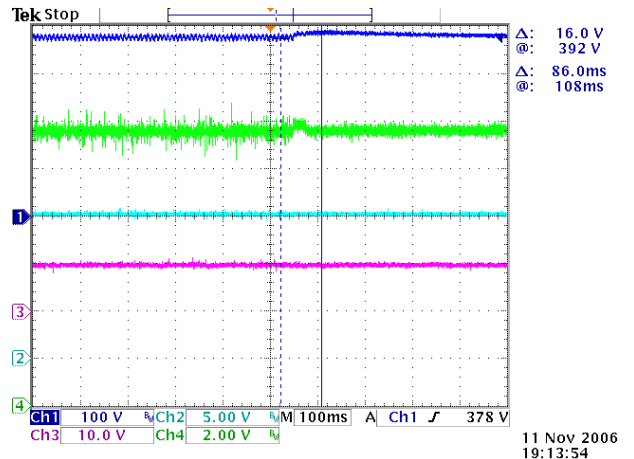

Ch1 is 380V bulk cap voltage which is 100V/div.  
Ch2 is VCC, Ch3 is SS(soft start pin), CH4 is Vo(12V)

AC power cycling :

90VAC turn on 500ms turn off 100ms at 10%LOAD

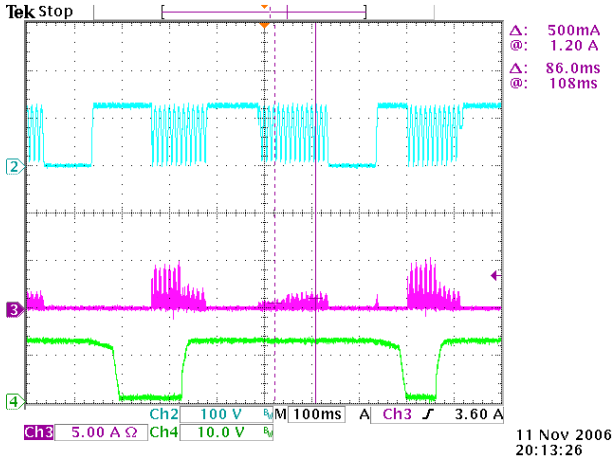

Ch2 is AC input voltage which is 100V/div.  
Ch3 is PFC stage Mosfet drain current, CH4 is Vo(12V)

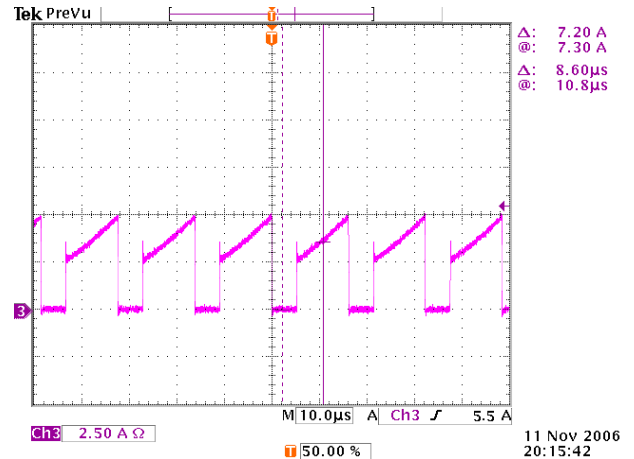

Ch3 is PFC stage Mosfet Drain current(zoom In)

90VAC turn on 500ms turn off 100ms at 100%LOAD

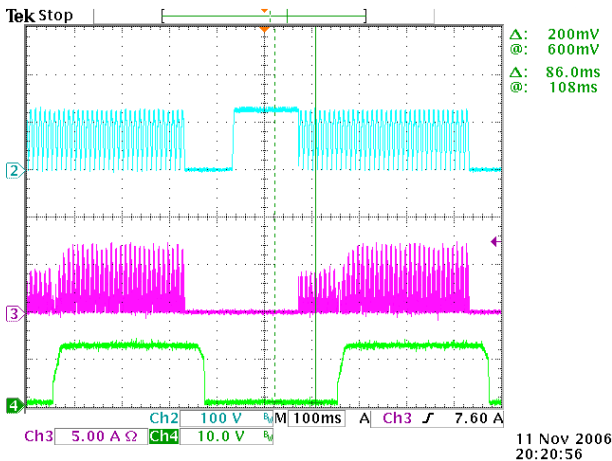

Ch2 is AC input voltage which is 100V/div.  
Ch3 is PFC stage Mosfet drain current, CH4 is Vo(12V)

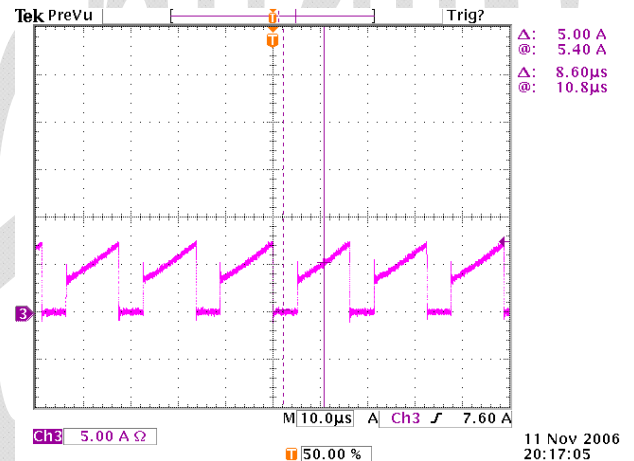

Ch3 is PFC stage Mosfet Drain current(zoom In)

90VAC turn on 500ms turn off 10ms at 10%LOAD

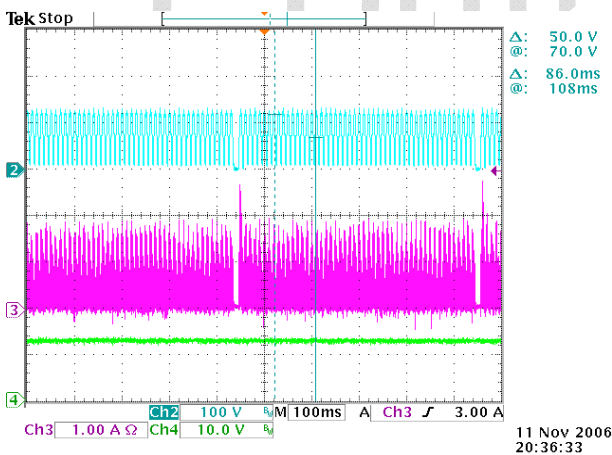

Ch2 is AC input voltage which is 100V/div.  
Ch3 is PFC stage Mosfet drain current, CH4 is Vo (12V)

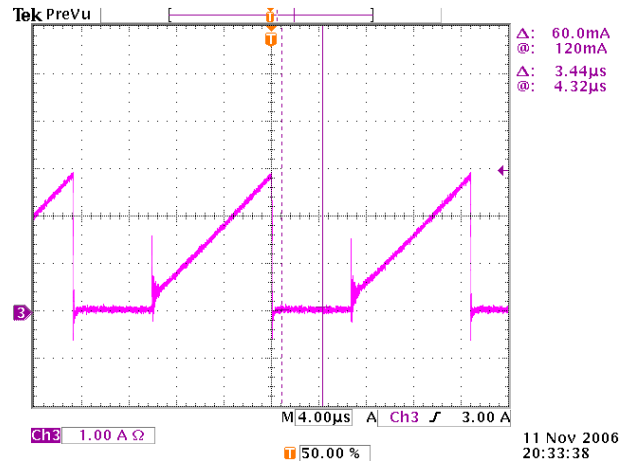

Ch3 is PFC stage Mosfet Drain current (zoom In)

**90VAC turn on 500ms turn off 10ms at 100%LOAD**

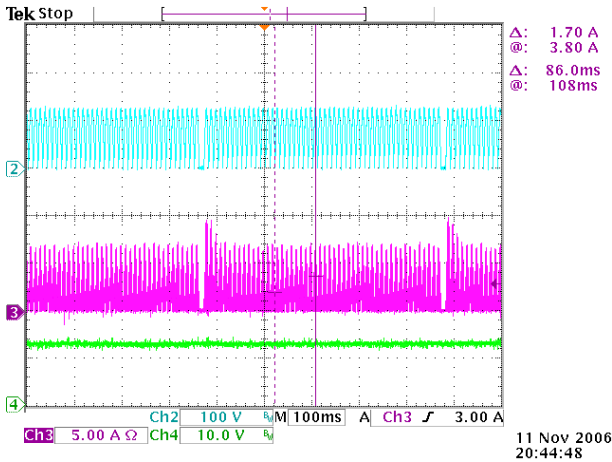

Ch2 is AC input voltage which is 100V/div.  
Ch3 is PFC stage Mosfet drain current, CH4 is Vo (12V)

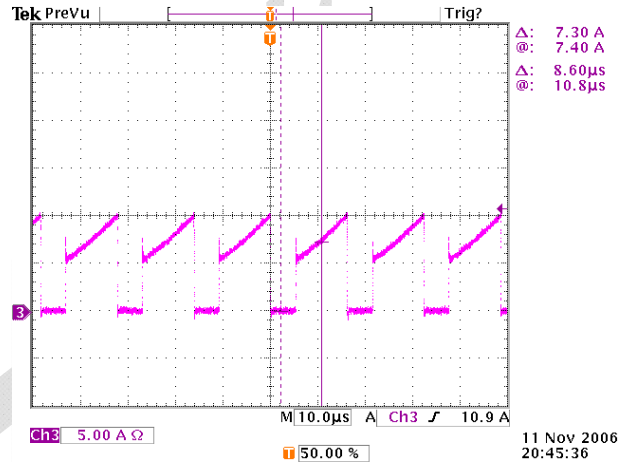

Ch3 is PFC stage Mosfet Drain current (zoom In)

**230VAC turn on 500ms turn off 100ms at 10%LOAD**

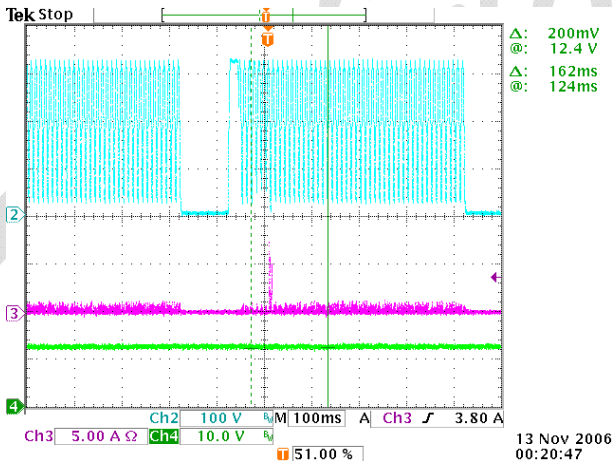

Ch2 is AC input voltage which is 100V/div.  
Ch3 is PFC stage Mosfet drain current, CH4 is Vo (12V)

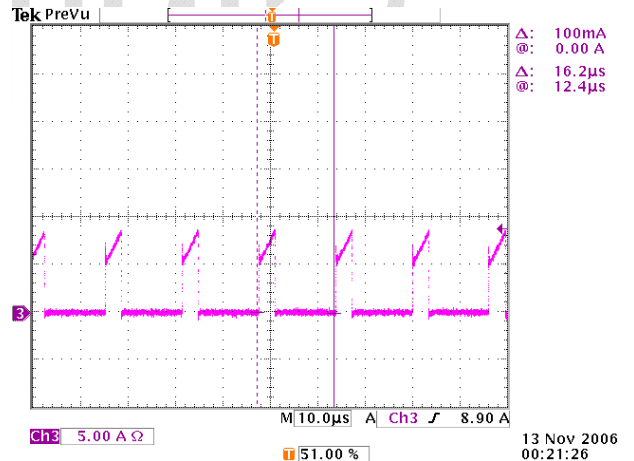

Ch3 is PFC stage Mosfet Drain current (zoom In)

**230VAC turn on 500ms turn off 100ms at 100%LOAD**

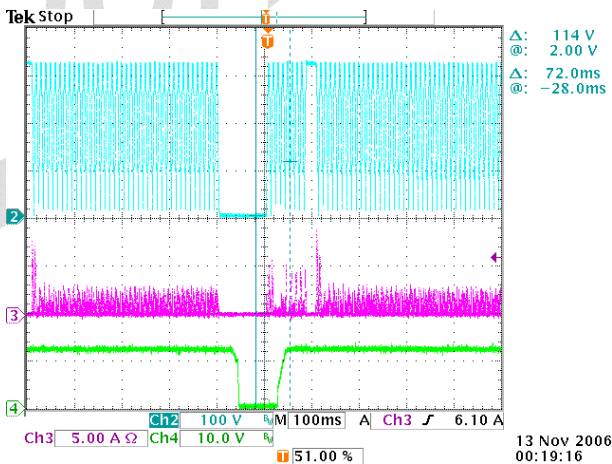

Ch2 is AC input voltage which is 100V/div.  
Ch3 is PFC stage Mosfet drain current, CH4 is Vo (12V)

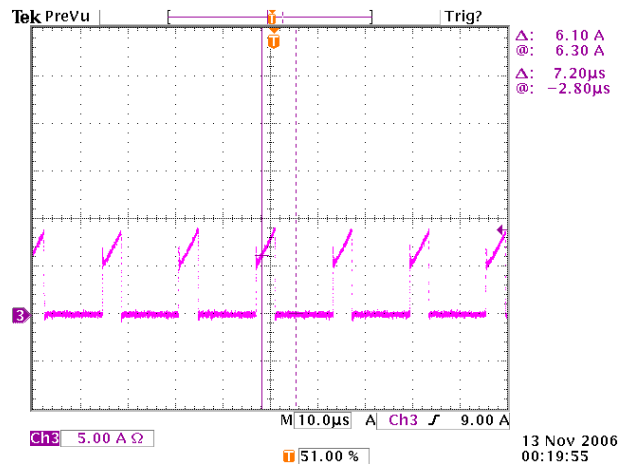

Ch3 is PFC stage Mosfet Drain current (zoom In)



**230VAC turn on 500ms turn off 10ms at 10%LOAD**

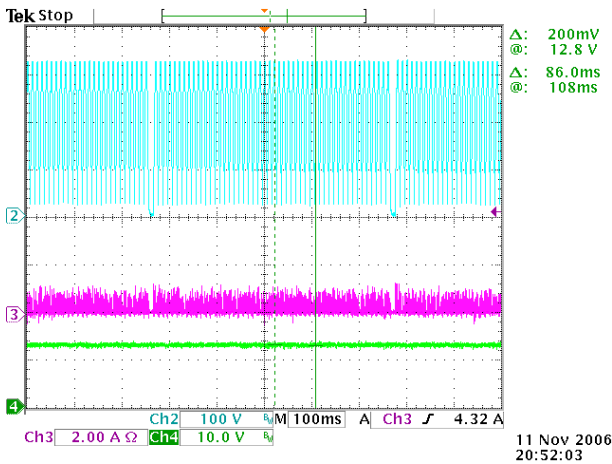

Ch2 is AC input voltage which is 100V/div.  
Ch3 is PFC stage Mosfet drain current, CH4 is Vo (12V)

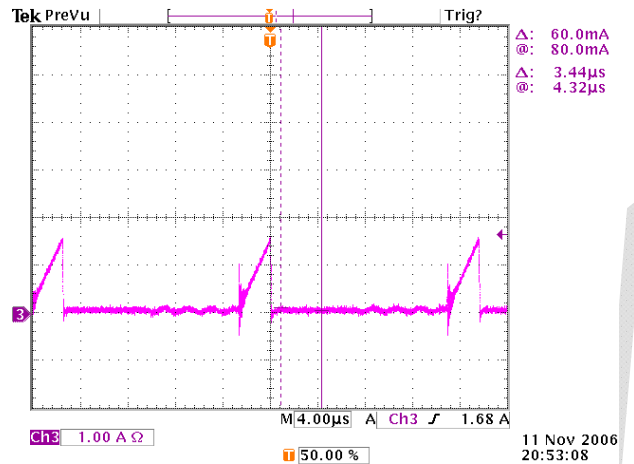

Ch3 is PFC stage Mosfet Drain current (zoom In)

**230VAC turn on 500ms turn off 10ms at 100%LOAD**

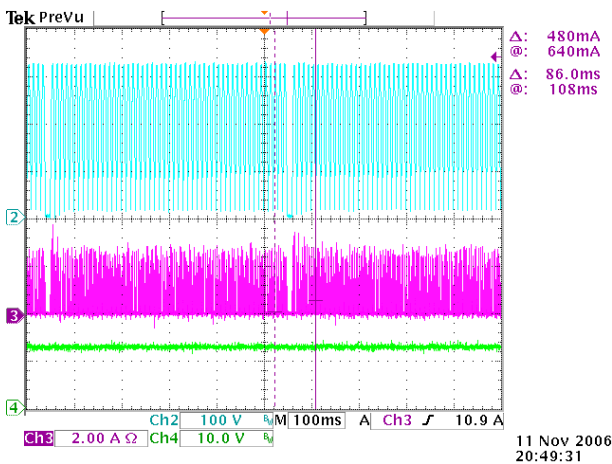

Ch2 is AC input voltage which is 100V/div.  
Ch3 is PFC stage Mosfet drain current, CH4 is Vo (12V)

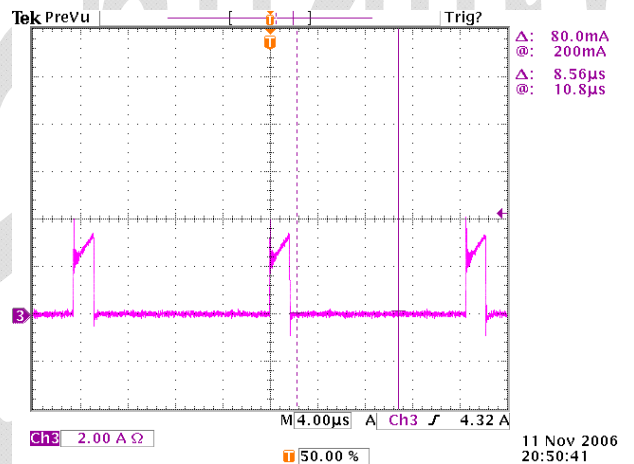

Ch3 is PFC stage Mosfet Drain current (zoom In)

**VFB Feed-Forward Performance at 20% Load Short-Circuit**

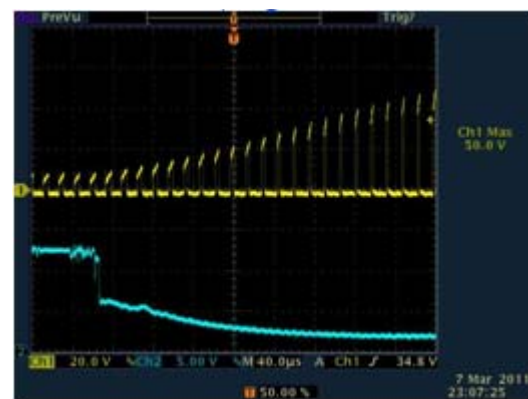
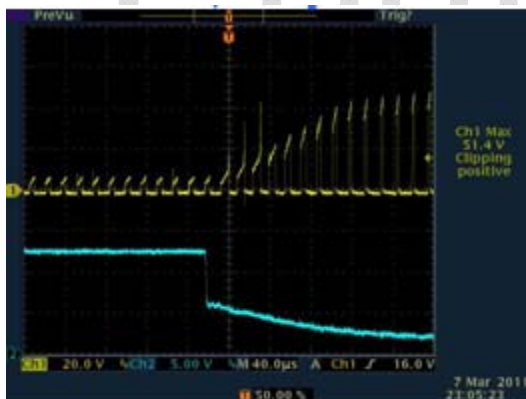

## Getting Start

To start evaluating CM6800U/02U/62U from the existing CM6800 or ML4800 board, 6 things need to be taken care before doing the fine tune:

- 1.) Change  $R_{AC}$  resistor (on pin 2,  $I_{AC}$ ) from the old value to a higher resistor value between 4.7 Mega ohms to 8 Mega ohms.
- 2.) Change  $R_{TCT}$  pin (pin 7) from the existing value to  $R_T=5.88K$  ohm and  $C_T=1000pF$  to have  $f_{PFC}=f_{PWM}=68$  KHz,  $f_{R_{TCT}}=272KHz$  for CM6800/02/62UA ;  $f_{PFC}=68KHz$ ,  $f_{PWM}=136KHz$ ,  $f_{R_{TCT}}=272KHz$  for CM6800/02/62UB
- 3.) Adjust all high voltage resistor around 5 mega ohm start value or higher.
- 4.) VRMS pin (pin 4) needs to be 1.14V at  $V_{IN}=80Vac$  and to be 1.21V at  $V_{IN}=80V_{AC}$  for universal input application from line input from  $80V_{AC}$  to  $270V_{AC}$ .
- 5.) At full load, the average VEA0 needs to around 4.5V and the ripple on the VEA0 needs to be less than 250mV when the light load comparator are triggered.
- 6.) Soft Start pin (pin 5), the soft start current has been reduced from CM6800's 20uA to CM6800U/02U/62U's 10uA. Soft Start capacitor can be reduced to 1/2 from your original CM6800 capacitor.

## Functional Description

CM6800U/02U/62U is designed for high efficient power supply for both full load and light load. It is a popular EPA/87+ PFC-PWM power supply controller.

The CM6800U/02U/62U consists of an average current controller continuous/discontinuous boost Power Factor Correction (PFC) front end and a synchronized Pulse Width Modulator (PWM) back end. The PWM can be used in either current or voltage mode. In voltage mode, feed-forward from the PFC output bus can be used to improve the PWM's line regulation. In either mode, the PWM stage uses conventional trailing edge duty cycle modulation, while the PFC uses leading edge modulation. This patented leading/trailing edge modulation technique results in a higher usable PFC error amplifier bandwidth, and can significantly reduce the size of the PFC DC bus capacitor.

The synchronized of the PWM with the PFC simplifies the PWM compensation due to the controlled ripple on the PFC output capacitor (the PWM input capacitor). In addition to power factor correction, a number of protection features have been built into the CM6800U/02U/62U. These include soft-start, PFC over-voltage protection, peak current limiting, brownout protection, duty cycle limiting, and under-voltage lockout.

## Power Factor Correction

Power factor correction makes a nonlinear load look like a resistive load to the AC line. For a resistor, the current drawn from the line is in phase with and proportional to the line voltage, so the power factor is unity (one). A common class of nonlinear load is the input of most power supplies, which use a bridge rectifier and capacitive input filter fed from the line. The peak-charging effect, which occurs on the input filter capacitor in these supplies, causes brief high-amplitude pulses of current to flow from the power line, rather than a sinusoidal current in phase with the line voltage. Such supplies present a power factor to the line of less than one (i.e. they cause significant current harmonics of the power line frequency to appear at their input). If the input current drawn by such a supply (or any other nonlinear load) can be made to follow the input voltage in instantaneous amplitude, it will appear resistive to the AC line and a unity power factor will be achieved.

To hold the input current draw of a device drawing power from the AC line in phase with and proportional to the input voltage, a way must be found to prevent that device from loading the line except in proportion to the instantaneous line voltage. The PFC section of the CM6800U/02U/62U uses a boost-mode DC-DC converter to accomplish this. The input to the converter is the full wave rectified AC line voltage. No bulk filtering is applied following the bridge rectifier, so the input voltage to the boost converter ranges (at twice line frequency) from zero volts to the peak value of the AC input and back to zero. By forcing the boost converter to meet two simultaneous conditions, it is possible to ensure that the current drawn from the power line is proportional to the input line voltage. One of these conditions is that the output voltage of the boost converter must be set higher than the peak value of the line voltage. A commonly used value is 385VDC, to allow for a high line of  $270V_{AC_{rms}}$ . The other condition is that the current drawn from the line at any given instant must be proportional to the line voltage. Establishing a suitable voltage control loop for the converter, which in turn drives a current error amplifier and switching output driver satisfies the first of these requirements. The second requirement is met by using the rectified AC line voltage to modulate the output of the voltage control loop. Such modulation causes the current error amplifier to command a power stage current that varies directly with the input voltage. In order to prevent ripple, which will necessarily appear at the output of boost circuit (typically about 10VAC on a 385V DC level); from introducing distortion back through the voltage error amplifier, the bandwidth of the voltage loop is deliberately kept low. A final refinement is to adjust the overall gain of the PFC such to be proportional to  $1/(V_{in} \times V_{in})$ , which linearizes the transfer function of the system as the AC input to voltage varies.

Since the boost converter topology in the CM6800U/02U/62U PFC is of the current-averaging type, no slope compensation is required. (Average Current Mode Control)

## Dynamic Soft PFC (patent pending)

Besides all the goodies from CM6800A, Dynamic Soft PFC is the main feature of CM6800U/02U/62U. Dynamic Soft PFC is improve the efficiency, to reduce power device stress, to ease EMI, and to ease the monotonic output design while it has the more protection such as the short circuit with power-fold-back protection. Its unique sequential control maximizes the performance and the protections among steady state, transient and the power on/off conditions.

## PFC Section

### Gain Modulator

Figure 1 shows a block diagram of the PFC section of the CM6800U/02U/62U. The gain modulator is the heart of the PFC, as it is this circuit block which controls the response of the current loop to line voltage waveform and frequency, rms line voltage, and PFC output voltages. There are three inputs to the gain modulator. These are:

1. A current representing the instantaneous input voltage (amplitude and wave-shape) to the PFC. The rectified AC input sine wave is converted to a proportional current via a resistor and is then fed into the gain modulator at  $I_{AC}$ . Sampling current in this way minimizes ground noise, as is required in high power switching power conversion environments. The gain modulator responds linearly to this current.
2. A voltage proportional to the long-term RMS AC line voltage, derived from the rectified line voltage after scaling and filtering. This signal is presented to the gain modulator at  $V_{RMS}$ . The gain modulator's output is inversely proportional to  $V_{RMS}^2$ . The relationship between  $V_{RMS}$  and gain is illustrated in the Typical Performance Characteristics of this page.
3. The output of the voltage error amplifier, VEAO. The gain modulator responds linearly to variations in this voltage.

The output of the gain modulator is a current signal, in the form of a full wave rectified sinusoid at twice the line frequency. This current is applied to the virtual-ground (negative) input of the current error amplifier. In this way the gain modulator forms the reference for the current error loop, and ultimately controls the instantaneous current draw of the PFC from the power line. The general formula of the output of the gain modulator is:

$$I_{mul} = \frac{I_{AC} \times (VEAO - 0.7V)}{V_{RMS}^2} \times \text{constant}$$

$$\text{Gain} = I_{mul} / I_{AC}$$

$$K = \text{Gain} / (VEAO - 0.7V)$$

$$I_{mul} = K \times (VEAO - 0.7V) \times I_{AC}$$

Where K is in units of  $[V^{-1}]$

Note that the output current of the gain modulator is limited around  $100 \mu A$  and the maximum output voltage of the gain modulator is limited to  $100 \mu A \times 7.75K \approx 0.8V$ . This 0.8V also will determine the maximum input power.

However,  $I_{GAINMOD}$  cannot be measured directly from  $I_{SENSE}$ .  $I_{SENSE} = I_{GAINMOD} - I_{OFFSET}$  and  $I_{OFFSET}$  can only be measured when VEAO is less than 0.5V and  $I_{GAINMOD}$  is 0A. Typical  $I_{OFFSET}$  is around 25uA.

$I_{AC} = 20 \mu A$ ,  $VEAO = 6V$

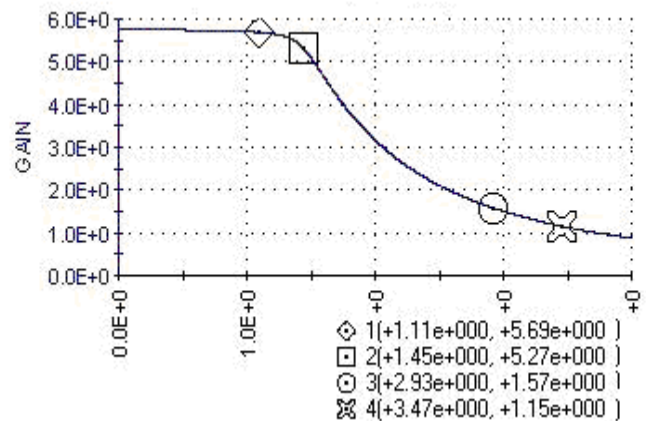

Gain vs. VRMS (pin4)

When  $V_{RMS}$  below 1V, the PFC is shut off. Designer needs to design  $80V_{AC}$  with  $V_{RMS}$  average voltage = 1.14V.

$$\text{Gain} = \frac{I_{SENSE} - I_{OFFSET}}{I_{AC}} = \frac{I_{MUL}}{I_{AC}}$$

### Selecting $R_{AC}$ for IAC pin

$I_{AC}$  pin is the input of the gain modulator.  $I_{AC}$  also is a current mirror input and it requires current input. By selecting a proper resistor  $R_{AC}$ , it will provide a good sine wave current derived from the line voltage and it also helps program the maximum input power and minimum input line voltage.

$R_{AC} = V_{in \text{ min peak}} \times 53.03K$ . For example, if the minimum line voltage is  $80V_{AC}$ , the  $R_{AC} = 80 \times 1.414 \times 53.03K = 6 \text{ Mega ohm}$ .

## VRMS Description

VRMS is the one of the input for PFC Gain Modulator. Besides it is the input of the Gain Modulator, it also serves for Clean Digital PFC Brown Out function:

VRMS is used to detect the AC Brown Out (Also, we can call it Clean Digital PFC brown out.). When VRMS is less than 1.0 V +/-3%, PFCOUT will be turned off and VEAO will be softly discharged. When VRMS is greater than 1.78V +/-3%, PFCOUT is enabled and VEAO is released.

VRMS pin is designed for the following functions:

1. VRMS is used to detect the AC Brown Out (Also, we can call it Clean Digital PFC brown out.). When VRMS is less than 1.0 V +/-3%, PFCOUT will be turned off and VEAO will be softly discharged. When VRMS is greater than 1.78V +/-3%, PFCOUT is enabled and VEAO is released.
2. VRMS also is used to determine if the AC Line is high line or it is low line. If VRMS is above 3.0V +/- 5%, IC will recognize it is high line the. If VRMS is below 2.0V +/- 5%, it is low line. Between 2V <= VRMS <= 3.0, it is the hysteresis.
3. In CM6802/62U Family , at High Line and Light Load, 380V to 342V (Vfb threshold moves from 2.5V to 2.28V) is prohibited. At Low Line and Light Load, 380V to 342V (Vfb threshold moves from 2.5V to 2.28V) is enable. It provides ZVS-Like performance.

Clean Digital PFC Brown Out provides a clean cut off when AC input is much lower than regular AC input voltage such as 70Vac.

Inside of Clean Digital PFC Brown Out, there is a comparator monitors the VRMS (pin 4) voltage. Clean Digital PFC Brown Out inhibits the PFC, and VEAO (PFC error amplifier output) is pulled down when the VRMS is lower than off threshold, 1.0V (The off Vin voltage usually corresponds to 70Vac). When the VRMS voltage reaches 1.78V (The On Vin voltage usually corresponds to 86.6V and when Vin = 80Vac, VRMS = 1.14V), PFC is on.

Before PFC is turned on, VRMS (pin 4) represents the peak voltage of the AC input. Before PFC is turned off, VRMS (pin 4) represents the VRMS voltage of the AC input.

## PFC Cycle-By-Cycle Current Limiter and Selecting R<sub>SENSE</sub>

The I<sub>SENSE</sub> pin, as well as being a part of the current feedback loop, is a direct input to the cycle-by-cycle current limiter for the PFC section. Should the input voltage at this pin ever be more negative than -1.25V, the output of the PFC will be disabled until the protection flip-flop is reset by the clock pulse at the start of the next PFC power cycle.

R<sub>S</sub> is the sensing resistor of the PFC boost converter. During the steady state, line input current x R<sub>SENSE</sub> = I<sub>muli</sub> x 7.75K. Since the maximum output voltage of the gain modulator is I<sub>muli</sub> max x 7.75K ≈ 0.8V during the steady state, R<sub>SENSE</sub> x line input current will be limited below 0.8V as well. When V<sub>EAO</sub> reaches maximum VEAO which is 6V, I<sub>SENSE</sub> can reach 0.8V. At 100% load, VEAO should be around 4.5V and I<sub>SENSE</sub> average peak is 0.6V. It will provide the optimal dynamic response + tolerance of the components.

Therefore, to choose R<sub>SENSE</sub>, we use the following equation:

$$R_{SENSE} + R_{Parasitic} = 0.55V_{TYPICAL} \times V_{IN,PEAK} / (2 \times \text{Line Input power})$$

For example, if the input voltage is 100V<sub>AC</sub>, and the maximum input power is 200Watt, R<sub>SENSE</sub> + R<sub>PARASITISM</sub> = (0.55V x 100V x 1.414) / (2 x 200) = 0.194 ohm. The designer needs to consider the parasitic resistance and the margin of the power supply and dynamic response. Assume R<sub>PARASITISM</sub> = 0.03ohm, R<sub>SENSE</sub> = 0.191ohm.

## PFC OVP

In the CM6800U/02U/62U, PFC OVP comparator serves to protect the power circuit from being subjected to excessive voltages if the load should suddenly change. A resistor divider from the high voltage DC output of the PFC is fed to VFB. When the voltage on VFB exceeds ~ 2.75V, the PFC output driver is shut down. The PWM section will continue to operate. The OVP comparator has 250mV of hysteresis, and the PFC will not restart until the voltage at VFB drops below ~ 2.55V. The VFB power components and the CM6800U/02U/62U are within their safe operating voltages, but not so low as to interfere with the boost voltage regulation loop.

The Current Loop Gain (S)

$$\begin{aligned} &= \frac{\Delta V_{ISENSE} * \Delta D_{OFF} * \Delta I_{EAO}}{\Delta D_{OFF} * \Delta I_{EAO} * \Delta I_{SENSE}} \\ &\approx \frac{V_{OUTDC} * R_S}{S * L * 2.5V} * GM_I * Z_{CI} \end{aligned}$$

Z<sub>CI</sub> : Compensation Net Work for the Current Loop

GM<sub>I</sub> : Trans-conductance of IEAO

V<sub>OUTDC</sub> : PFC Boost Output Voltage; typical designed value is 380V and we use the worst condition to calculate the Z<sub>CI</sub>

R<sub>SENSE</sub> : The Sensing Resistor of the Boost Converter

2.5V : The Amplitude of the PFC Leading Edge Modulation Ramp(typical)

L : The Boost Inductor

## Clean Digital PFC Brown Out

Clean Digital PFC Brown Out provides a clean cut off when AC input is much lower than regular AC input voltage such as 70Vac.

Inside of Clean Digital PFC Brown Out, there is a comparator monitors the  $V_{RMS}$  (pin 4) voltage. Clean Digital PFC Brown Out inhibits the PFC, and VEAO (PFC error amplifier output) is pulled down while  $V_{RMS}$  is lower than off threshold, 1.0V and  $I_{AC}$  is detected 0.5V (The off  $V_{in}$  voltage usually corresponds to 75Vac). When the  $V_{RMS}$  voltage reaches 1.78V (The On  $V_{in}$  voltage usually corresponds to 86.6V and when  $V_{in} = 80Vac$ ,  $V_{RMS} = 1.14V$ ), PFC is on.

Before PFC is turned on,  $V_{RMS}$  (pin 4) represents the peak voltage of the AC input. Before PFC is turned off,  $V_{RMS}$  (pin 4) represents the  $V_{RMS}$  voltage of the AC input.

## Current Error Amplifier, IEAO

The current error amplifier's output controls the PFC duty cycle to keep the average current through the boost inductor a linear function of the line voltage. At the inverting input to the current error amplifier, the output current of the gain modulator is summed with a current which results from a negative voltage being impressed upon the  $I_{SENSE}$  pin. The negative voltage on  $I_{SENSE}$  represents the sum of all currents flowing in the PFC circuit, and is typically derived from a current sense resistor in series with the negative terminal of the input bridge rectifier.

In higher power applications, two current transformers are sometimes used, one to monitor the IF of the boost diode. As stated above, the inverting input of the current error amplifier is a virtual ground. Given this fact, and the arrangement of the duty cycle modulator polarities internal to the PFC, an increase in positive current from the gain modulator will cause the output stage to increase its duty cycle until the voltage on  $I_{SENSE}$  is adequately negative to cancel this increased current. Similarly, if the gain modulator's output decreases, the output duty cycle will decrease, to achieve a less negative voltage on the  $I_{SENSE}$  pin.

## Error Amplifier Compensation

The PWM loading of the PFC can be modeled as a negative resistor; an increase in input voltage to the PWM causes a decrease in the input current. This response dictates the proper compensation of the two trans-conductance error amplifiers. Figure 2 shows the types of compensation networks most commonly used for the voltage and current error amplifiers, along with their respective return points. The current loop compensation is returned to  $V_{REF}$  to produce a soft-start characteristic on the PFC: as the reference voltage comes up from zero volts, it creates a differentiated voltage on  $I_{EAO}$  which prevents the PFC from immediately demanding a full duty cycle on its boost converter.

The gain vs. input voltage of the CM6800U/02U/62U's voltage error amplifier,  $V_{EAO}$  has a specially shaped non-linearity such that under steady-state operating conditions the trans-conductance of the error amplifier,  $GM_v$  is at a local minimum. Rapid perturbation in line or load conditions will cause the input to the voltage error amplifier ( $V_{FB}$ ) to  $I_{SENSE}$  Filter, the RC filter between  $R_{SENSE}$  and  $I_{SENSE}$  :

There are 2 purposes to add a filter at  $I_{SENSE}$  pin:

- 1.) Protection: During start up or inrush current conditions, it will have a large voltage cross  $R_s$  which is the sensing resistor of the PFC boost converter. It requires the  $I_{SENSE}$  Filter to attenuate the energy.
- 2.) To reduce L, the Boost Inductor: The  $I_{SENSE}$  Filter To reduce L, the Boost Inductor: The  $I_{SENSE}$  Filter also can reduce the Boost Inductor value since the  $I_{SENSE}$  Filter behaves like an integrator before going  $I_{SENSE}$  which is the input of the current error amplifier, IEAO.

The  $I_{SENSE}$  Filter is a RC filter. The resistor value of the  $I_{SENSE}$  Filter is between 100 ohm and 50 ohm because  $I_{OFFSET} \times$  the resistor can generate an offset voltage of IEAO. By selecting  $R_{FILTER}$  equal to 50 ohm will keep the offset of the IEAO less than 5mV. Usually, we design the pole of  $I_{SENSE}$  Filter at  $f_{pfc}/6=8.33Khz$ , one sixth of the PFC switching frequency. Therefore, the boost inductor can be reduced 6 times without disturbing the stability. Therefore, the capacitor of the  $I_{SENSE}$  Filter,  $C_{FILTER}$ , will be around 381nF.

## PFC Voltage Loop

There are two major concerns when compensating the voltage loop error amplifier, VEAO ; stability and transient response. Optimizing interaction between transient response and stability requires that the error amplifier's open-loop crossover frequency should be 1/2 that of the line frequency, or 23Hz for a 47Hz line (lowest anticipated international power frequency).

deviate from its 2.5V (nominal) value. If this happens, the trans-conductance of the voltage error amplifier, GM<sub>v</sub> will increase significantly, as shown in the Typical Performance Characteristics. This raises the gain-bandwidth product of the voltage loop, resulting in a much more rapid voltage loop response to such perturbations than would occur with a conventional linear gain characteristics.

The Voltage Loop Gain (S)

$$\begin{aligned} &= \frac{\Delta V_{OUT}}{\Delta V_{EAO}} * \frac{\Delta V_{FB}}{\Delta V_{OUT}} * \frac{\Delta V_{EAO}}{\Delta V_{FB}} \\ &\approx \frac{P_{IN} * 2.5V}{V_{OUTDC}^2 * \Delta V_{EAO} * S * C_{DC}} * GM_v * Z_{CV} \end{aligned}$$

**Z<sub>CV</sub>** : Compensation Net Work for the Voltage Loop

**GM<sub>v</sub>** : Trans-conductance of VEAO

**P<sub>IN</sub>** : Average PFC Input Power

**V<sub>OUTDC</sub>** : PFC Boost Output Voltage; typical designed value is 380V.

**C<sub>DC</sub>** : PFC Boost Output Capacitor

## PFC Current Loop

The current trans-conductance amplifier, GM<sub>i</sub>, I<sub>EAO</sub> compensation is similar to that of the voltage error amplifier, VEAO with exception of the choice of crossover frequency. The crossover frequency of the current amplifier should be at least 10 times that of the voltage amplifier, to prevent interaction with the voltage loop. It should also be limited to less than 1/6th that of the switching frequency, e.g. 8.33kHz for a 50kHz switching frequency.

## Generating V<sub>CC</sub>

After turning on CM6800U/02U/62U at 13V, the operating voltage can vary from 10V to 17.9V. That's the two ways to generate V<sub>CC</sub>. One way is to use auxiliary power supply around 15V, and the other way is to use bootstrap winding to self-bias CM6800U/02U/62U system. The bootstrap winding can be either taped from PFC boost choke or from the transformer of the DC to DC stage. The ratio of winding transformer for the bootstrap should be set between 18V and 15V.

A filter network is recommended between V<sub>CC</sub> (pin 13) and bootstrap winding. The resistor of the filter can be set as following.

$$\begin{aligned} R_{FILTER} * I_{VCC} &\sim 2V, I_{VCC} = I_{OP} + (Q_{PFCFET} + Q_{PWMFET}) * f_{sw} \\ I_{OP} &= 3mA \text{ (typ.)} \end{aligned}$$

### EXAMPLE:

With a wanting voltage called, V<sub>BIAS</sub>, of 18V, a V<sub>CC</sub> of 15V and the CM6800U/02U/62U driving a total gate charge of 90nC at 100kHz (e.g. 1 IRF840 MOSFET and 2 IRF820 MOSFET), the gate driver current required is:

$$I_{GATEDRIVE} = 100kHz * 90nC = 9mA$$

$$\begin{aligned} R_{BIAS} &= \frac{V_{BIAS} - V_{CC}}{I_{CC} + I_G} \\ R_{BIAS} &= \frac{18V - 15V}{5mA + 9mA} \end{aligned}$$

Choose R<sub>BIAS</sub> = 214Ω

The CM6800U/02U/62U should be locally bypassed with a 1.0 μF ceramic capacitor. In most applications, an electrolytic capacitor of between 47 μF and 220 μF is also required across the part, both for filtering and as part of the start-up bootstrap circuitry.

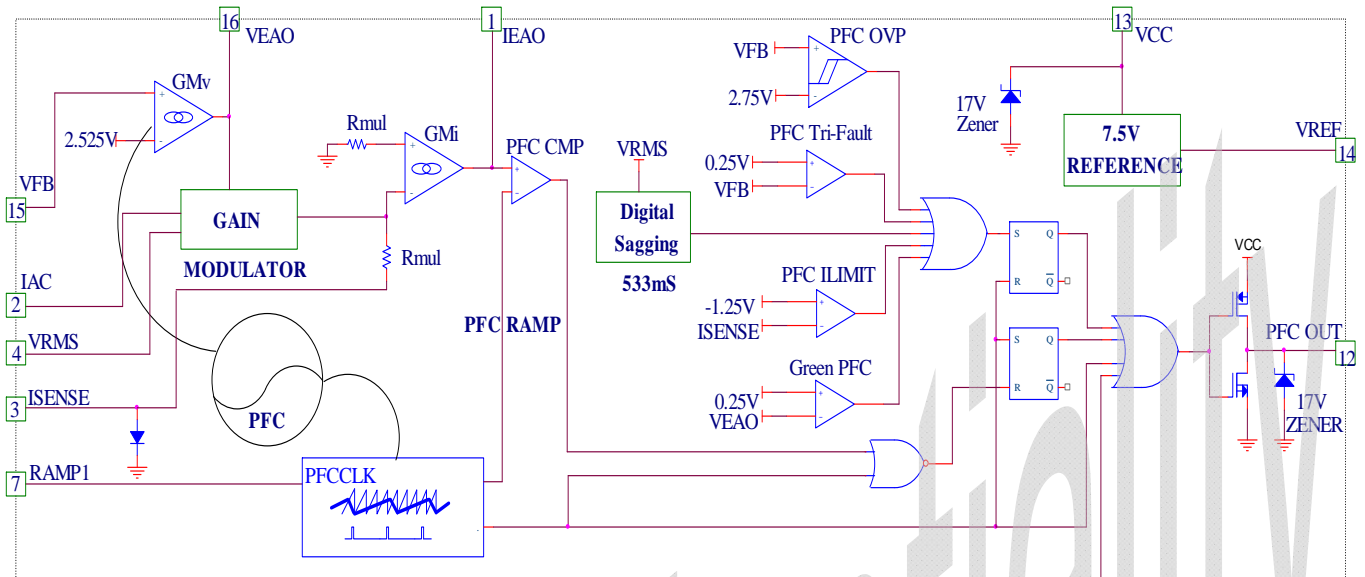

Figure 1. PFC Section Block Diagram

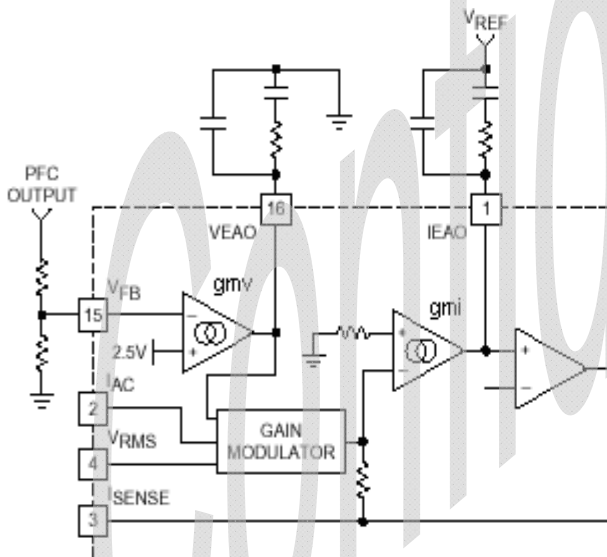

Figure 2. Compensation Network Connections for the Voltage and Current Error Amplifiers

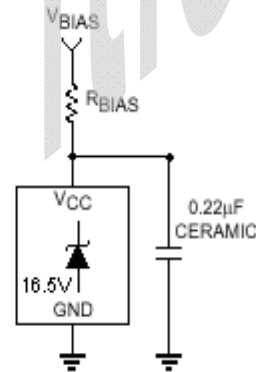

Figure 3. External Component Connections to VCC

## Oscillator (RAMP1, or called RTCT)

In CM6800/02/62UA,  $f_{RTCT} = 4 \times f_{PWM} = 4 \times f_{PFC}$   $f_{RTCT} = 272$  KHz,  $f_{PWM} = 68$  KHz and  $f_{PFC} = 68$  KHz ; In CM6800/02/62UB,  $f_{RTCT} = 4 \times f_{PFC} = 2 \times f_{PWM}$ ,  $f_{PFC} = 68$  KHz,  $f_{PWM} = 136$  KHz,  $f_{RTCT} = 272$  KHz, it provides the best performance in the PC application.

The oscillated frequency,  $f_{RTCT}$  is the similar formula in CM6800:

$$f_{RTCT} = \frac{1}{t_{RAMP} + t_{DEADTIME}}$$

The dead time of the oscillator is derived from the following equation:

$$t_{RAMP} = R_T \times C_T \times \ln \frac{V_{REF} - 1}{V_{REF} - 3.75}$$

at  $V_{REF} = 7.5V$ :

$$t_{RAMP} = R_T \times C_T \times 0.55$$

The dead time of the oscillator may be determined using:

$$t_{DEADTIME} = \frac{2.5V}{11mA} \times C_T = 227 \times C_T \text{ (typ.)}$$

The dead time is so small ( $t_{RAMP} \gg t_{DEADTIME}$ ) that the operating frequency can typically be approximately by:

$$f_{RTCT} = \frac{1}{t_{RAMP}}$$

$C_T$  should be greater than 470pF.

Let us use 1000PF Solving for  $R_T$  yields 5.88K. Selecting standard components values,  $C_T = 1000$ pF, and  $R_T = 5.88$ k $\Omega$

The dead time of the oscillator determined two things:

- 1.) PFC minimum off time which is the dead time
- 2.) PWM skipping reference duty cycle: when the PWM duty cycle is less than the dead time, the next cycle will be skipped and it reduces no load consumption in some applications.

## PWM Section

### Pulse Width Modulator

The PWM section of the CM6800U/02U/62U is straightforward, but there are several points which should be noted. Foremost among these is its inherent synchronization to the PFC section of the device, from which it also derives its basic timing. The PWM is capable of current-mode or voltage-mode operation.

In current-mode applications, the PWM ramp (RAMP2) is usually derived directly from a current sensing resistor or current transformer in the primary of the output stage, and is thereby representative of the current flowing in the converter's output stage.  $DCI_{LIMIT}$ , which provides cycle-by-cycle current limiting, is typically connected to RAMP2 in such applications. For voltage-mode, operation or certain specialized applications, RAMP2 can be connected to a separate RC timing network to generate a voltage ramp against which  $V_{DC}$  will be compared. Under these conditions, the use of voltage feed-forward from the PFC buss can assist in line regulation accuracy and response. As in current mode operation, the DC  $I_{LIMIT}$  input is used for output stage over-current protection.

No voltage error amplifier is included in the PWM stage of the CM6800U/02U/62U, as this function is generally performed on the output side of the PWM's isolation boundary. To facilitate the design of opto-coupler feedback circuitry, an offset has been built into the PWM's RAMP2 input which allows  $V_{DC}$  to command a zero percent duty cycle for input voltages below around 2V.

### PWM Current Limit ( $DCI_{LIMIT}$ )

The DC  $I_{LIMIT}$  pin is a direct input to the cycle-by-cycle current limiter for the PWM section. Should the input voltage at this pin ever exceed 1V, the output flip-flop is reset by the clock pulse at the start of the next PWM power cycle. Beside, the cycle-by-cycle current, when the DC  $I_{LIMIT}$  triggered the cycle-by-cycle current. It will limit PWM duty cycle mode. Therefore, the power dissipation will be reduced during the dead short condition.

When  $DCI_{LIMIT}$  pin is connected with RAMP2 pin, the CM6800U/02U/62U's PWM section becomes a current mode PWM controller. Sometimes, network between  $DCI_{LIMIT}$  and RAMP2 is a resistor divider so the  $DCI_{LIMIT}$ 's 1V threshold can be amplified to 2V or higher for easy layout purpose.

### PWM Brown Out (380V-OK Comparator)

The 380V-OK comparator monitors the DC output of the PFC and inhibits the PWM if this voltage on  $V_{FB}$  is less than its nominal 2.36V. Once this voltage reaches 2.36V, which corresponds to the PFC output capacitor being charged to its rated boost voltage, the soft-start begins. It is a hysteresis comparator and its lower threshold is 1.25V.



### PWM Control (RAMP2)

When the PWM section is used in current mode, RAMP2 is generally used as the sampling point for a voltage representing the current on the primary of the PWM's output transformer, derived either by a current sensing resistor or a current transformer. In voltage mode, it is the input for a ramp voltage generated by a second set of timing components ( $R_{RAMP2}$ ,  $C_{RAMP2}$ ), that will have a minimum value of zero volts and should have a peak value of approximately 5V. In voltage mode operation, feed-forward from the PFC output bus voltage is an excellent way to derive the timing ramp for the PWM stage.

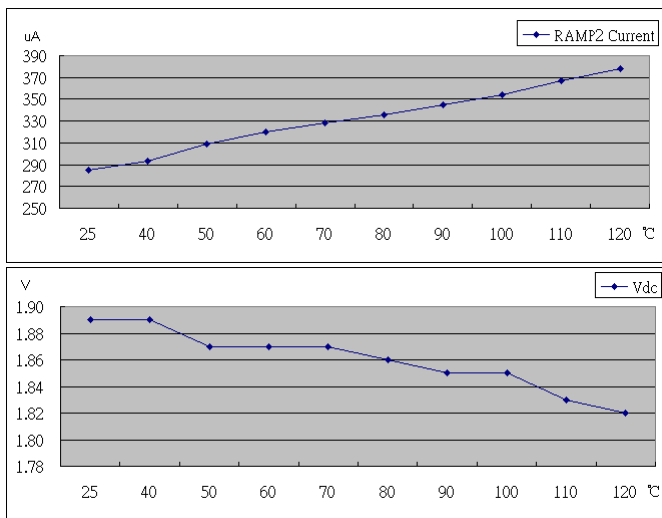

### Soft Start (SS)

Start-up of the PWM is controlled by the selection of the external capacitor at SS. A current source of 10  $\mu$ A supplies the charging current for the capacitor, and start-up of the PWM begins at SS~1.8V.

### Leading/Trailing Modulation

Conventional Pulse Width Modulation (PWM) techniques employ trailing edge modulation in which the switch will turn on right after the trailing edge of the system clock. The error amplifier output is then compared with the modulating ramp up. The effective duty cycle of the trailing edge modulation is determined during the ON time of the switch. Figure 4 shows a typical trailing edge control scheme.

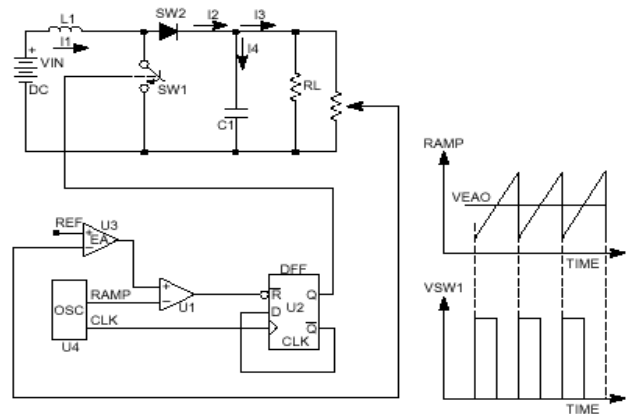

Figure 4. Typical Trailing Edge Control Scheme

In case of leading edge modulation, the switch is turned OFF right at the leading edge of the system clock. When the modulating ramp reaches the level of the error amplifier output voltage, the switch will be turned ON. The effective duty-cycle of the leading edge modulation is determined during OFF time of the switch.

Figure 5 shows a leading edge control scheme. One of the advantages of this control technique is that it required only one system clock. Switch 1(SW1) turns off and switch 2 (SW2) turns on at the same instant to minimize the momentary "no-load" period, thus lowering ripple voltage generated by the switching action. With such synchronized switching, the ripple voltage of the first stage is reduced. Calculation and evaluation have shown that the 120Hz component of the PFC's output ripple voltage can be reduced by as much as 30% using this method.

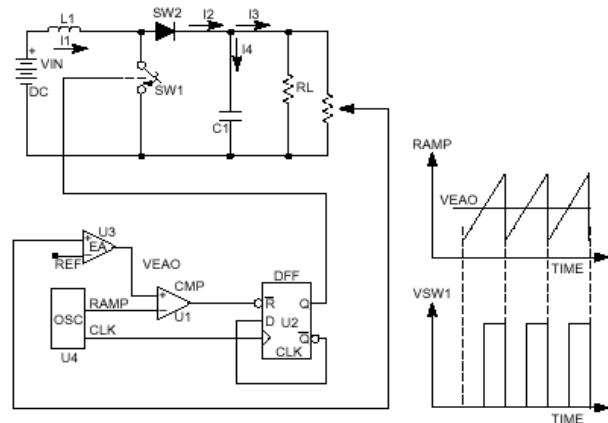
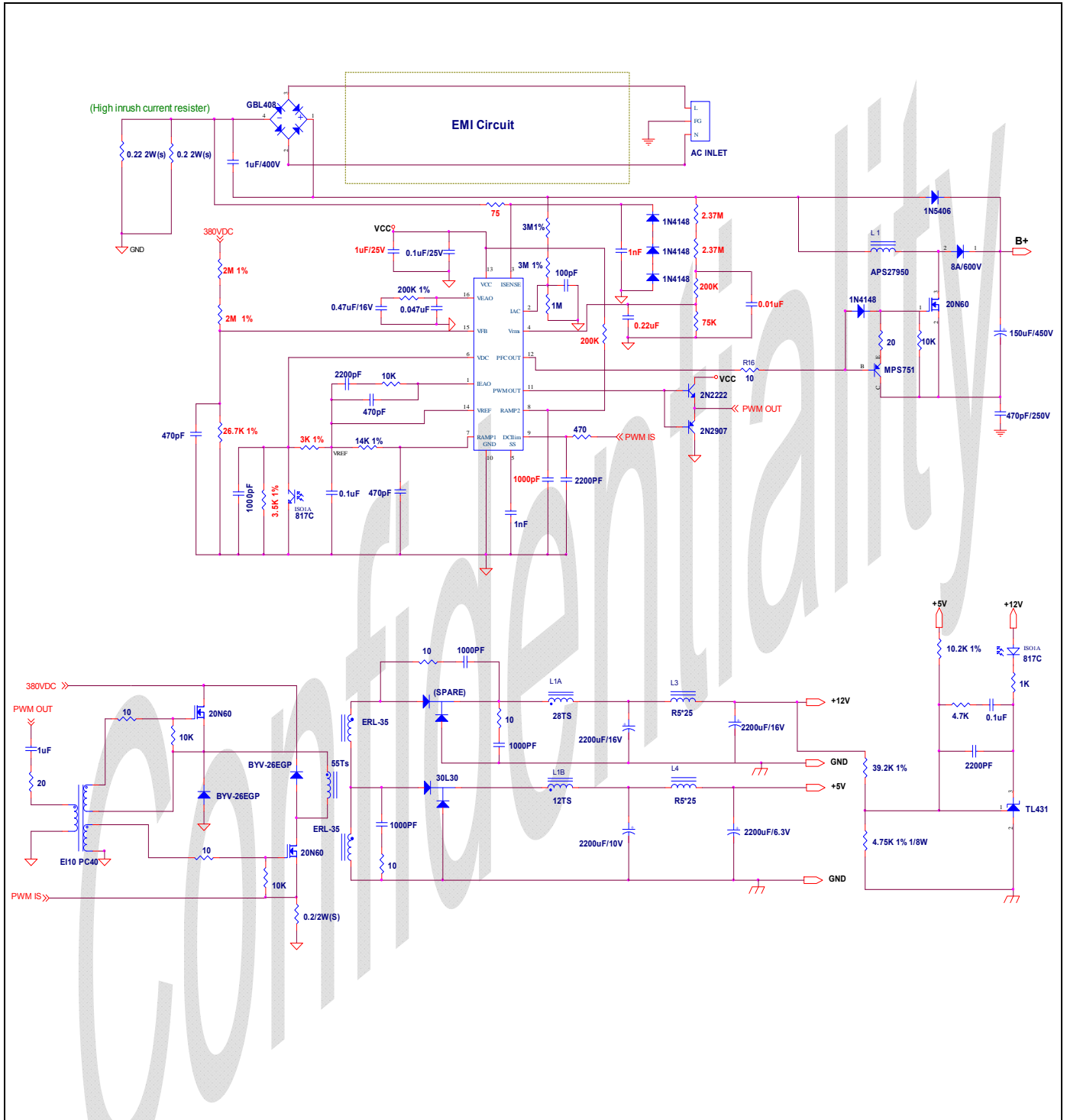
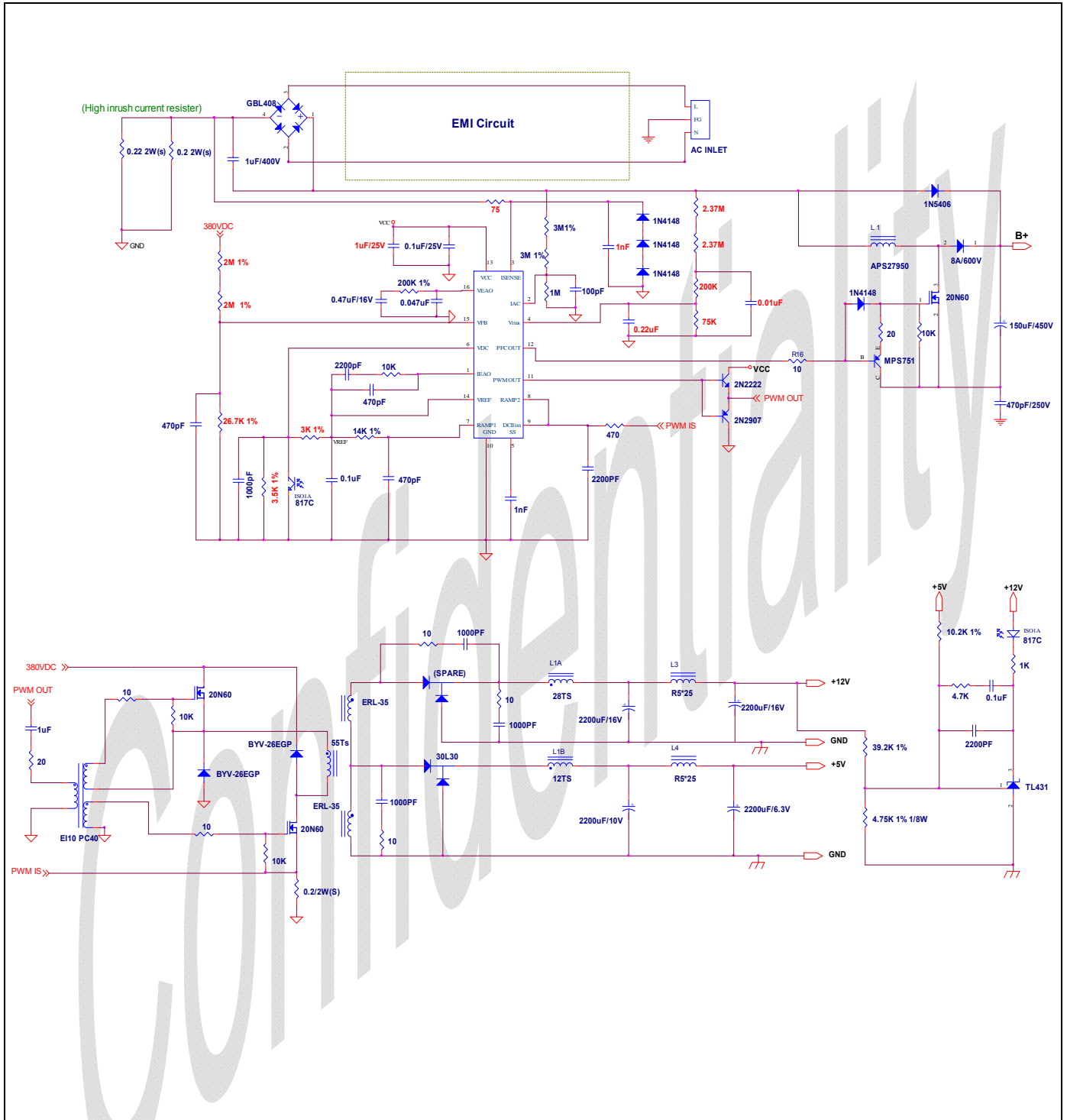

Figure 5. Typical Leading Edge Control Scheme

APPLICATION CIRCUIT (Voltage Mode)



APPLICATION CIRCUIT (Current Mode)



## PACKAGE DIMENSION

### 16-PIN PDIP (P16)

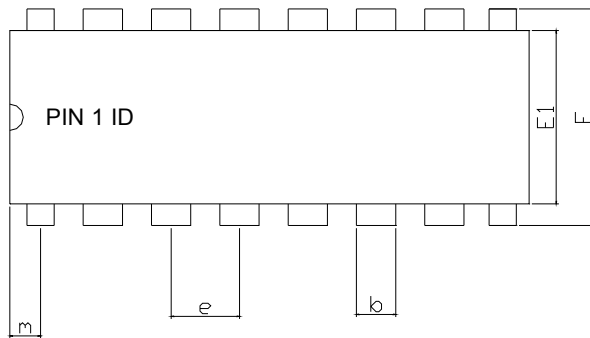

| SYMBOLS | DIMENSIONS IN MILLIMETERS |      |       | DIMENSIONS IN INCHS |       |       |
|---------|---------------------------|------|-------|---------------------|-------|-------|
|         | MIN                       | NOM  | MAX   | MIN                 | NOM   | MAX   |
| A       | ---                       | ---  | 4.32  | ---                 | ---   | 0.170 |
| A1      | 0.38                      | ---  | ---   | 0.015               | ---   | ---   |
| b       | 1.40                      | ---  | 1.65  | 0.055               | ---   | 0.065 |
| b1      | 0.40                      | ---  | 0.56  | 0.016               | ---   | 0.022 |
| C       | 0.20                      | ---  | 0.31  | 0.008               | ---   | 0.012 |
| D       | 18.79                     | ---  | 19.31 | 0.740               | ---   | 0.760 |
| E       | 7.49                      | ---  | 8.26  | 0.295               | ---   | 0.325 |
| E1      | 6.09                      | ---  | 6.61  | 0.240               | ---   | 0.260 |
| e       | ---                       | 2.54 | ---   | ---                 | 0.100 | ---   |
| L       | 3.18                      | ---  | ---   | 0.125               | ---   | ---   |
| m       | 0.50                      | ---  | ---   | 0.02                | ---   | ---   |
| θ       | 0°                        | ---  | 15°   | 0°                  | ---   | 15°   |

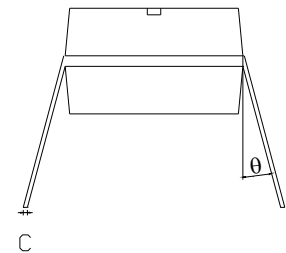
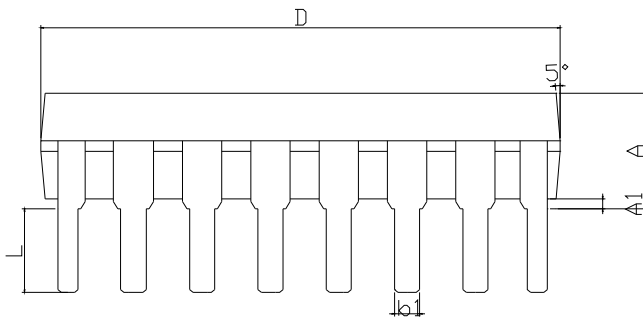

### 16-PIN SOP (S16)

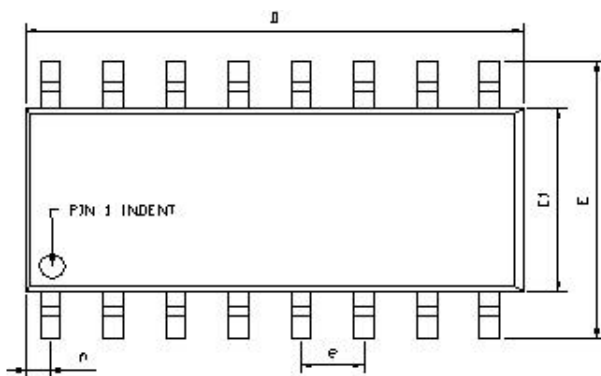

| SYMBOLS | DIMENSIONS IN MILLIMETERS |      |       | DIMENSIONS IN INCHS |       |       |
|---------|---------------------------|------|-------|---------------------|-------|-------|
|         | MIN                       | NOM  | MAX   | MIN                 | NOM   | MAX   |
| A1      | 0.10                      | ---  | 0.25  | 0.004               | ---   | 0.010 |
| A2      | 1.40                      | ---  | 1.55  | 0.055               | ---   | 0.061 |
| b       | 0.30                      | ---  | 0.51  | 0.012               | ---   | 0.020 |
| C       | 0.15                      | ---  | 0.26  | 0.006               | ---   | 0.010 |
| D       | 9.80                      | ---  | 10.06 | 0.386               | ---   | 0.396 |
| E       | 5.79                      | ---  | 6.20  | 0.228               | ---   | 0.244 |
| E1      | 3.76                      | ---  | 4.01  | 0.148               | ---   | 0.158 |
| e       | ---                       | 1.27 | ---   | ---                 | 0.050 | ---   |
| L       | 0.38                      | ---  | 0.69  | 0.015               | ---   | 0.035 |
| m       | 0.43                      | ---  | 0.69  | 0.017               | ---   | 0.027 |
| θ       | 0°                        | ---  | 8°    | 0°                  | ---   | 8°    |

EXPOSED PAD DIMENSION : (mm)  
PAD SIZE : X=2.3 , Y=2.8

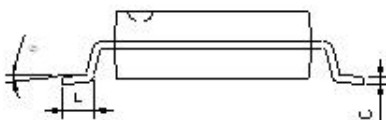
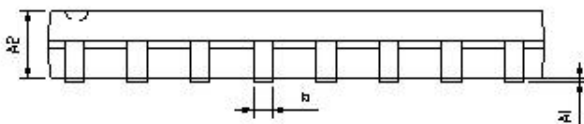

#### NOTES:

1. JEDEC OUTLINE : MS-012 AC
2. DIMENSIONS "D" DOES NOT INCLUDE MOLD FLASH, PROTRUSIONS OR GATE BURRS. MOLD FLASH, PROTRUSIONS AND GATE BURRS SHALL NOT EXCEED 0.15mm. PER SIDE.
3. DIMENSIONS "E1" DOES NOT INCLUDE INTER-LEAD FLASH, OR PROTRUSIONS. INTER-LEAD FLASH AND PROTRUSIONS SHALL NOT EXCEED 0.25mm PER SIDE.



## IMPORTANT NOTICE

Champion Microelectronic Corporation (CMC) reserves the right to make changes to its products or to discontinue any integrated circuit product or service without notice, and advises its customers to obtain the latest version of relevant information to verify, before placing orders, that the information being relied on is current.

A few applications using integrated circuit products may involve potential risks of death, personal injury, or severe property or environmental damage. CMC integrated circuit products are not designed, intended, authorized, or warranted to be suitable for use in life-support applications, devices or systems or other critical applications. Use of CMC products in such applications is understood to be fully at the risk of the customer. In order to minimize risks associated with the customer's applications, the customer should provide adequate design and operating safeguards.

### HsinChu Headquarter

5F, No. 11, Park Avenue II,  
Science-Based Industrial Park,  
HsinChu City, Taiwan

TEL : +886-3-567 9979  
FAX : +886-3-567 9909  
<http://www.champion-micro.com>

### Sales & Marketing

21F., No. 96, Sec. 1, Sintai 5th Rd., Sijhih City,  
Taipei County 22102,  
Taiwan, R.O.C.

TEL : +886-2-2696 3558  
FAX : +886-2-2696 3559